



633

Field Production Mixer with
Integrated Recorder

User Guide

Legal Notices

Product specifications and features are subject to change without prior notification.

Copyright © 2017 Sound Devices, LLC. All rights reserved.

This product is subject to the terms and conditions of a software license agreement provided with the product, and may be used in accordance with the license agreement.

This document is protected under copyright law. An authorized licensee of this product may reproduce this publication for the licensee's own personal use. This document may not be reproduced or distributed, in whole or in part, for commercial purposes, such as selling copies or providing educational services or support.

This document is supplied as a technical guide. Special care has been taken in preparing the information for publication; however, since product specifications are subject to change, this document might contain omissions and technical or typographical inaccuracies. Sound Devices, LLC does not accept responsibility for any losses due to the user of this guide.

Trademarks

The "wave" logo and USBPre are registered trademarks; FileSafe, PowerSafe, SuperSlot, MixAssist, and QuickBoot are trademarks of Sound Devices, LLC. Mac and OS X are trademarks of Apple Inc., registered in the U.S. and other countries. Windows and Microsoft Excel are registered trademarks of Microsoft Corporation in the U.S. and other countries. All other trademarks herein are the property of their respective owners.

FCC Notice

This device complies with part 15 of the FCC Rules. Operation is subject to the following two conditions: (1) This device may not cause harmful interference, and (2) This device must accept any interference received, including interference that may cause undesired operation.

FCC Part 15.19(a)(3)

Manual Conventions

Symbol	Description
>	This symbol is used to show the order in which you select menu commands and sub-options, such as: Main Menu > Audio indicates you press the Menu button for the Main Menu, then scroll to and select Audio by pushing the Control Knob.
+	A plus sign is used to show button or keystroke combinations. For instance, Ctrl+V means to hold the Control key down and press the V key simultaneously. This also applies to other controls, such as switches and encoders. For instance, MIC+HP turn means to slide and hold the MIC/TONE switch left while turning the Headphone (HP) encoder. METERS+SELECT means to hold the METERS button down as you press the SELECT encoder.
ⓘ	A note provides recommendations and important related information. The text for notes also appears italicized in a different color.
	A cautionary warning about a specific action that could cause harm to you, the device, or cause you to lose data. Follow the guidelines in this document or on the unit itself when handling electrical equipment. The text for cautionary notes also appears italicized and bold in a different color.

633 User Guide • Rev 4-C • January 16, 2019

This document is distributed by Sound Devices, LLC in online electronic (PDF) format only. E-published in the USA.

www.sounddevices.com

support@sounddevices.com

Sound Devices, LLC

E7556 Road 23 and 33

Reedsburg, Wisconsin 53959 USA

Direct: +1 (608) 524-0625

Toll Free: (800) 505-0625

Fax: +1 (608) 524-0655

Revision History

This table provides the revision history and cross-reference links to “what’s new” in this guide.

Rev#	Date	Firmware Version	Description
1-A	Feb 2016	v2.11	Initial Official Release of Redesigned Publication Includes Firmware feature updates for: <ul style="list-style-type: none">• CL-12 Integration: “CL-12 Linear Fader Controller” on page 151• External TC User Bits: “Setting User Bits” on page 80• QR Codes: “Viewing User Guide via Smart Phone QR Code” on page 107
1-B	Apr 2016	v2.11	Minor document edits; fix broken cross-ref links.
3-A	June 2016	v3.10	Includes Firmware feature updates for: <ul style="list-style-type: none">• Added new chapter on Remote Control of 6-Series mixers.• In CL-12 chapter, added new section “Disabling Output Controls” on page 167.• In File Storage chapter, added new section “Changing the Take Designator” on page 89.
3-B	July 2016	v3.10	Minor document edits: fix page-numbering realignment.
4-A	Sept 2016	v4.00	Added new chapter “Wingman” covering how to use the Wingman iOS-based app that, when paired with the WM-Connect Bluetooth® Smart USB dongle, enables remote control of any 6-Series mixer.
4-B	Feb 2017	v4.50	Added new chapter “MixAssist & Dugan Automixing” covering the new Auto Mixer feature added to the 633.
4-C	Apr 2017	v4.51	Updated Wingman chapter with information on Wingman Password.

Table of Contents

Overview of Chassis

Front Panel	9	Right Side Panel	12
Left Side Panel	12	Back Panel	13

The LCD and User Interface

Meter Views	15	Accessing the Main Menu	17
Using Meter Views	16	Customizing the LCD and LEDs	18
Customizing Meter Views	16	Using LCD Daylight Mode	18

Headphone Monitoring

Connecting Headphones	19	Defining Custom Headphone Presets	21
Selecting Headphone Source	19	Choosing a Favorite Headphone Preset	22
Setting Headphone Encoder Mode	20	Using Headphone Source Shortcuts	22
Configuring the Headphone Preset List	20	Headphone Peak LED	22

Power

Powering the 633	23	PowerSafe	26
Using External Power	23	QuickBoot	27
Using Battery Power	24	Forcing Power Off (Optional)	27
Voltage Ranges and Thresholds	24	Power Consumption	27
Configuring Power Settings	25		

Inputs

Physical Input Controls	29	Adjusting Trim and Fader Controls	35
Activating an Input	30	Adjusting Pan	36
Accessing the Input Setting Screens	30	Accessing Input Settings	36
Setting Input Source	32	Configuring Linking	37
Setting Input High-Pass Filters	33	Configuring Phantom Voltage	38
Setting L, R, X1, and X2 Routing	33	Configuring the PFL Toggle Mode	38
Using a Track Name Shortcut	34	Configuring Input to ISO Routing	39
Inverting the Phase	35	Configuring Input Delay	40

Outputs

Output Connections	41	Accessing AES Output Routing Screen	44
Adjusting Output Gain	41	Accessing Aux (X1 - X4) Routing Screens	45
Accessing Output Settings	42	Configuring Playback to Outputs	47
Configuring Output Linking	43	Adjusting Output Delay	47
Setting Output Type and Nominal Level	43	Sending Tone to Outputs	48
Output Routing	44		

MixAssist & Dugan Automixing

Auto Mixer Screen	49	Setting MixAssist Off-Attenuation	52
Turning the Auto Mixer On or Off	50	LCD Views During MixAssist Automixing	53
Assigning Inputs to the Auto Mixer	51	Overview of Dugan Automixing	54
Overview of MixAssist	51	LCD Views During Dugan Automixing	54

Limiters

Overview	57	Adjusting the Threshold	58
Enabling the Limiters	58	Linking Limiters	58

Recording

Using Media	61	Setting the Sample Rate	66
Using the Transport Control	62	F Sample Modes	67
Arming or Disarming Recording Tracks	63	Setting the Bit Depth	67
Accessing Recorder Settings	64	Setting the Pre-roll	68
Setting File Type and Media Track Assignment	65	Using the Slate Microphone	68
WAV (Broadcast WAV)	65	Playing Back Active Takes	69
MP3	65	Viewing Approved Media List via Smart Phone	69
Changing the MP3 Bit Rate	66		

Slate Mic and Return

Disabling the Slate Microphone	71	Using the Slate for Notation	73
Setting Slate Mic Gain	72	RTN Monitoring	73
Routing the Slate Mic	72		

Timecode

Timecode	75	Jamming the Timecode	78
Setting the Timecode Mode	76	Setting the Timecode Generator	78
Setting the Frame Rate	77	Setting User Bits	79
Setting Timecode Hold Off	77	Setting Display Mode	80

File Storage

File Structure	81	Changing the Take Designator	88
Transferring Files to PC	82	Defining File Max Size	88
Take List and File List	82	Setting Scene Increment Mode	88
Accessing the File List	83	Setting Take Reset Mode	89
Deleting Files or Folders	84	Setting File Playback Mode	89
File Storage Settings	84	Selecting a Default Playback Card	90
Setting Folder Options	86	Erasing / Formatting Media	90
Generating Sound Reports	87		

Metadata and Take List

Take List Overview	93	Clearing Scene List	96
Accessing the Take List	94	Metadata Overview	97
Playing Takes	94	Renaming or Deleting Previous Takes	98
Editing Metadata on the 633	94	Editing Metadata in Other Programs	98
Using the Phrase List for Notes	95		

System

Setting up Tones and Bells	99	Calibrating Faders & Pans	105
Configuring Record/Stop and Warning Bells	100	Using a USB Keyboard	106
Configuring the Meters	101	Viewing Shortcut Information	106
Setting Meter Ballistics and Peak Hold	102	Viewing User Guide via Smart Phone QR Code	106
Setting Peak Hold	103	Viewing Version Information	107
Setting up Date and Time Parameters	103	Updating Firmware	107

Quick Setup

Saving Settings	109	Deleting Quick Setup Files	110
Copying Quick Setup Files	110	Loading Previously Saved Settings	111

Shortcuts

Front Panel Shortcuts	113	USB Keyboard Shortcuts	115
---------------------------------	-----	----------------------------------	-----

Wingman Integration: 6-Series

Starting Wingman	117	Editing Track Names.	125
Setting up Wingman Password.	117	Arming/Disarming Tracks.	126
User Interface	118	Take List View	127
Transport View	120	Editing a Take's Metadata	128
Connecting to a 6-Series Mixer	121	Reports View	129
Using Transport Controls.	123	Creating Sound Reports.	131
Designating Circle and False Takes.	123	About View	131
Using Meter Views	124	Track View on iPhone or iPod Touch	132

Third-Party Remote Control

Control in the Palm of Your Hand	135	Web-based Wireless Remote Control.	139
iOS Remote Control Connection Diagrams.	137	Web-based Remote Control Connection Diagrams	140
iOS Remote Control Examples	138	Web-based Remote Control Examples	141

Specifications

Analog Inputs	143	Timecode and Sync	145
Digital Inputs	144	Power	146
Analog Outputs.	144	Environmental	146
Digital Outputs/Recorder	145	Dimensions and Weight	146

Accessories

Electronic Accessories	147	Cases	149
Cables and Connectors.	148	Software.	150

CL-12 Linear Fader Controller

Overview of Panels	151	Configuring Output Meters (688 only)	165
Top: EQ & OUTPUTS Sections	154	Disabling Output Controls.	165
Left: Channel Strip Section	155	Arming L, R, X1, X2 Tracks	165
Right: Buttons and HP Encoder	157	Using the 3-Band Equalizer (688 only)	166
Altered Functionality	159	Accessing the EQ Submenu.	167
Feature Comparison Chart	159	Bypassing EQ.	169
CL-12 Sub-menu	160	Setting the Q-Factor.	169
Selecting One or More Input Channels	161	Setting LF and HF Frequency Defaults.	170
Activating PFL of an Input	162	Setting LF and HF Filter Types.	170
Setting SEL to follow PFL.	162	Setting EQ Routing.	171
Trim Level Adjustment on 6-Series	162	Using High-pass Filters	171
Adjusting Trim Levels (688 only).	163	Naming Tracks	171
Adjusting Trim Levels (664 only).	163	Configuring User Programmable Buttons.	172
Adjusting Trim Levels (633 only).	163	Adjusting CL-12's LED Brightness	173
Routing Input Channels	164	Specifications.	173
Adjusting Output or Track Levels	164		

CS-633

Features 175

Specifications..... 175

Software License

Overview of Chassis

The 633 chassis is made of light-weight and durable metal.

The front panel of the chassis features several easy-to-reach controls, switches, LEDs, and a sunlight-visible LCD screen.

Its side panels provide a variety of connection options for ultimate I/O flexibility, and the back panel has battery mounts for ultimate portability.

Topics in this section include:

- ▶ Front Panel
- ▶ Left Side Panel
- ▶ Right Side Panel
- ▶ Back Panel

Front Panel

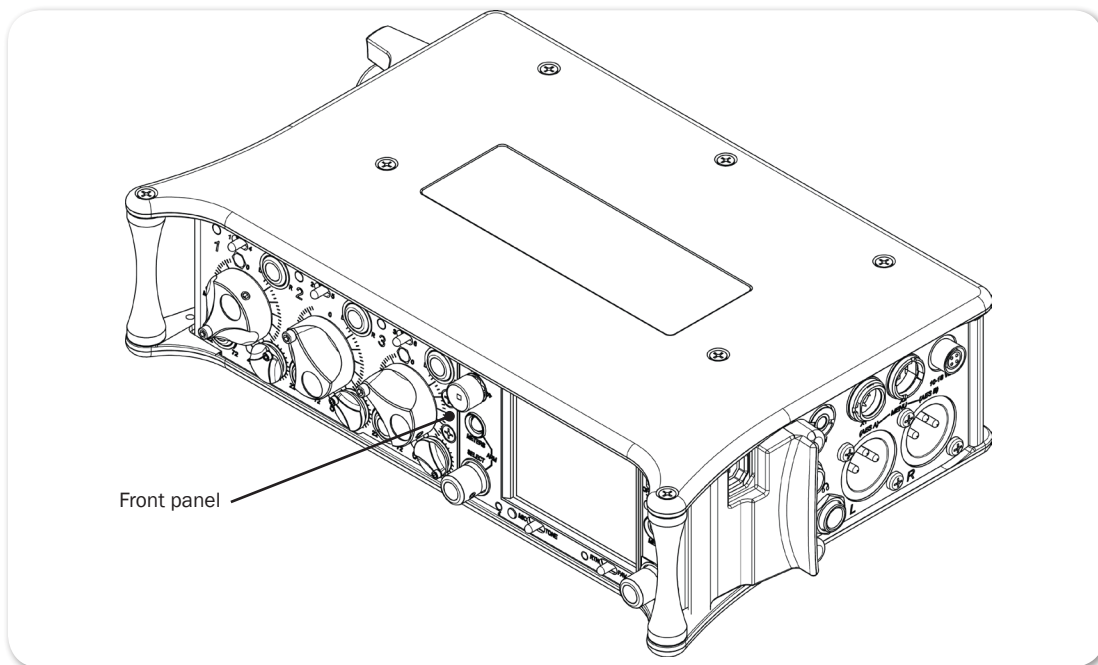

The front panel provides the LCD as well as several buttons, switches, and controls as defined in the following tables.

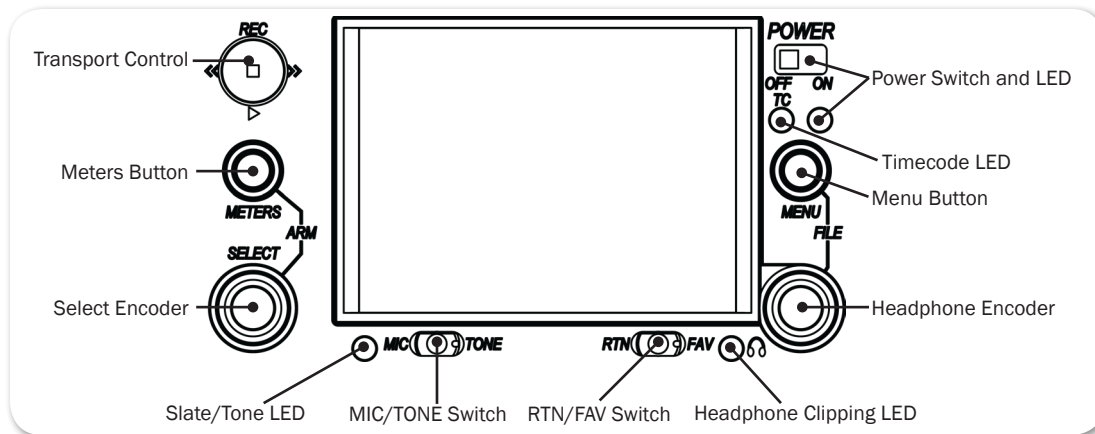

FEATURE	DESCRIPTION
Power Switch and LED	Powers 633 on and off, and indicates power status.
Timecode LED	Flashes blue to indicate whether the internal timecode generator (and QuickBoot) is active while the mixer is off.
Menu Button	Provides access to the Main menu. Also used for various shortcut functions.
Headphone Encoder	Adjusts headphone level and monitor source. Also used for various shortcut functions.
Headphone Clipping LED	Illuminates red to indicate headphone output is approaching clipping level.
RTN/FAV Switch	Toggles monitor source. Also used for various shortcut functions.
MIC/TONE Switch	Toggle slate mic and tone generator. Also used for various shortcut functions.
Slate/Tone LED	Indicates slate mic is active or tone generator is locked on.
Select Encoder	Multiple purpose rotary encoder. Also used for various shortcut functions.
Meters Button	Cycles between meter views. Also used for various shortcut functions.
Transport Control	Controls playback and recording. Also used for various shortcut functions.

Also on the front panel, there are three sets of controls related to inputs, such as pans, faders, and trims.

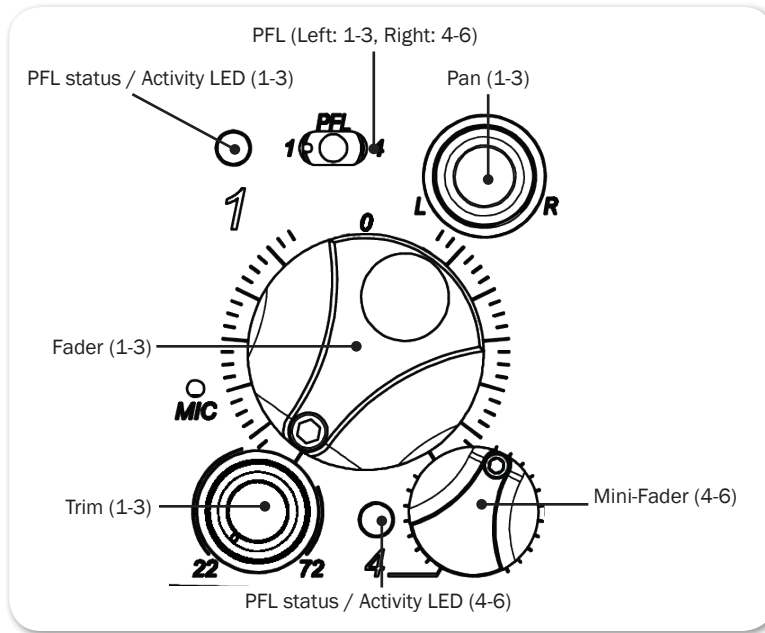

FEATURE	DESCRIPTION
PFL Switch	By default, this switch has dual-functionality. It activates Pre-Fade Listen (PFL) and displays Input Settings screen for input 1-3 (slide left) and 4-6 (slide right). Slide again to deactivate. The functionality of this switch may be altered via the Main menu's Inputs > PFL Toggle Mode. Does not affect Master Output signal. For momentary action, hold the switch for one second or longer. The input LED flashes yellow when an input's PFL is active.
Fader (1-3)	Adjusts fader level for inputs 1-3.
Mini-Fader (4-6)	Adjusts fader level for inputs 4-6.
Trim (1-3)	Adjusts trim level for inputs 1-3. Trim levels for inputs 4, 5, and 6 are controlled via their respective Input Settings screens.
Pan (1-3)	Adjusts pan between L and R tracks. Inputs 4, 5, and 6 are routed to the L and R mix via their respective Input Settings screens.
PFL status / Activity LED (1-3)	Indicates PFL status and input signal activity.
PFL status / Activity LED (4-6)	Indicates PFL status and input signal activity.
MIC	The slate microphone.

Left Side Panel

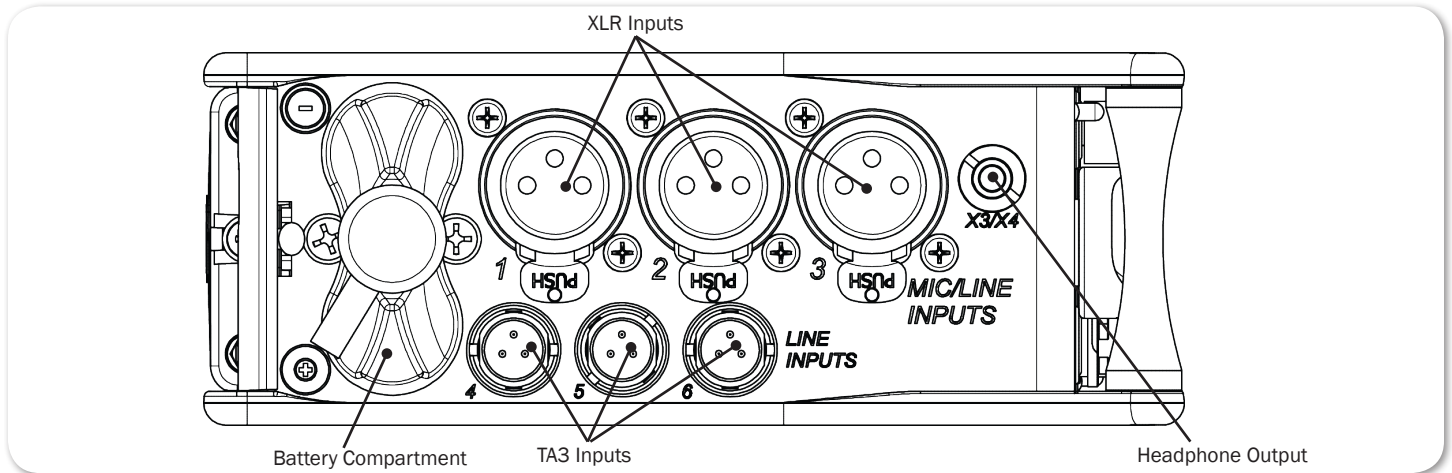

FEATURE	DESCRIPTION
XLR Inputs (1-3)	Active-balanced analog microphone- or line-level inputs. Input 1 can also accept AES3 or AES42 (Mode 1) signal. Pin-1 = ground, pin-2 = hot (+), and pin-3 = cold (-).
TA3 Inputs (4-6)	Active-balanced analog line-level inputs. Pin-1 = ground, pin-2 = hot (+), and pin-3 = cold (-). Float pin 3 to unbalance.
X3/X4 Output	Multi-purpose auxiliary analog output. Two channels on unbalanced 3.5mm TRS connection. Level can be adjusted from -30 dB (mic level) up to 0 dB (sufficient for driving headphones). Tip = left, ring = right, and sleeve = ground.
Battery Compartment	Holds six AA (LR6) batteries for backup powering. NiMH rechargeable cells advised. Top row inserted with negative (-) end facing out; Bottom row inserted with positive (+) end facing out.

Right Side Panel

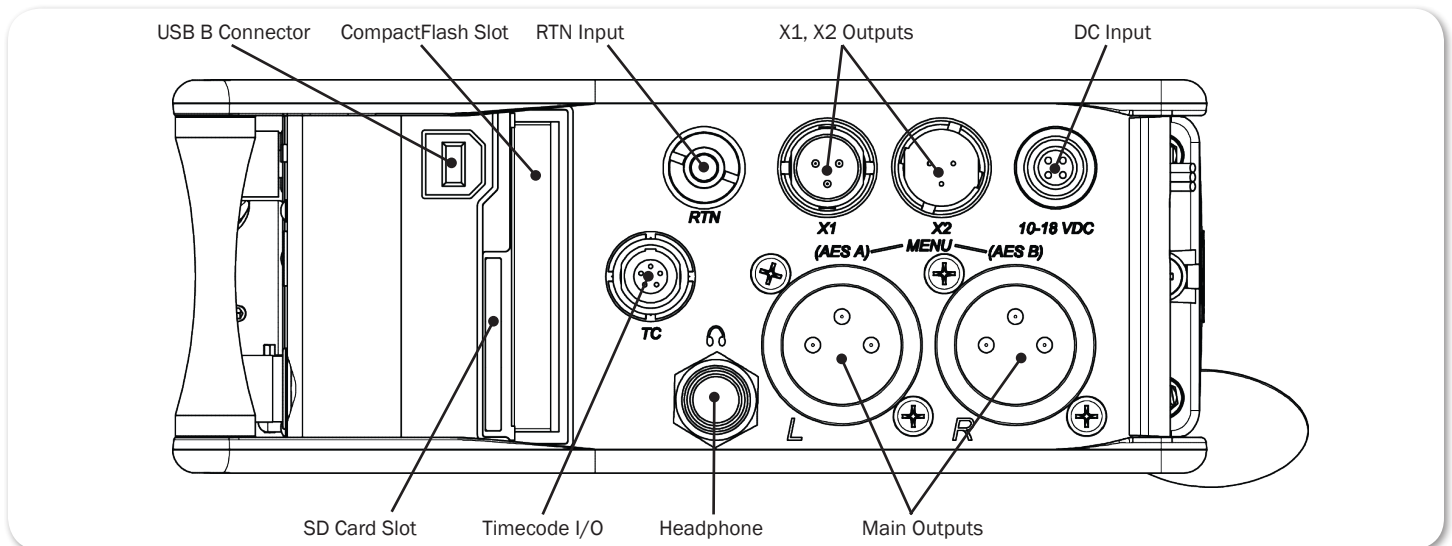

FEATURE	DESCRIPTION
USB B Connector	Factory use and keyboard connection (with adapter).
CompactFlash Slot	Accepts approved CompactFlash cards with the label-side toward the rear of the mixer. Compatible with Type I and Type II cards. High-speed UDMA cards are recommended for higher track count recording.
RTN Input	Unbalanced stereo 3.5 mm female connector for Return audio input. Sleeve = ground, tip = left, ring = right.
X1, X2 Outputs	Line, -10, or Mic level selected in Main menu OUTPUTS section. (Pin 1 = Ground, pin 2 = Hot (+), pin 3 = Cold (-)) Float pin 3 to unbalance.
DC Input	Accepts DC voltages from 10–18 V for powering. (Pin 1 = Negative (-), pin 4 = Positive (+))
SD Card Slot	Accepts SD/SDHC/SDXC cards with the notched corner oriented toward the top of the 633. High speed class 10 cards are recommended. Insert until it clicks securely in the slot. The card should glide smoothly into the slot. Press to eject.
Timecode I/O	Timecode input and output on 5-pin LEMO® connector.
Headphone Output	A 1/4" TRS headphone output. Can drive headphones from 8 to 1000 ohm impedances to very high levels. Tip = left, ring = right, and sleeve = ground.
Main Outputs	Transformer-balanced analog outputs on standard 3-pin XLR-3M connectors. Can be set to send AES3 digital signals (1,2 and 3,4 on L and R respectively) in Main menu OUTPUTS section. (Pin 1 = Ground; pin 2 = Hot (+); pin 3 = Cold (-)) Unbalance by grounding pin 3 to pin 1.

Back Panel

The back panel provides additional powering options for the 633 with two L-type mounts for Lithium Ion batteries (not included):

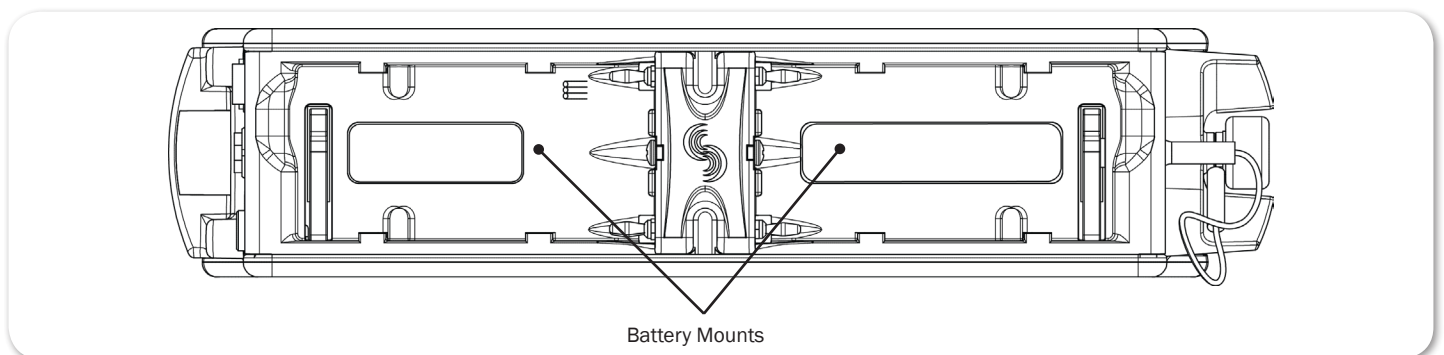

FEATURE	DESCRIPTION
Battery Mounts	Battery mounts (B1 and B2) on the 633's back panel are compatible with Sony® L-Series batteries. Any capacity supported.

The LCD and User Interface

The LCD display is the primary source of information when operating the 633. All settings are configured via the LCD display. All signal level meters can be displayed on the LCD display.

This chapter describes meter views, including the Main screen which is displayed when no other screens are active, the Main menu, and LCD Daylight mode.

Other screens, such as the Input Settings screen, are described where applicable throughout the guide.

Topics in this section include:

- ▶ Meter Views
 - ▶ Using Meter Views
 - ▶ Customizing Meter Views
- ▶ Accessing the Main Menu
- ▶ Customizing the LCD and LEDs
 - ▶ Using LCD Daylight Mode

Meter Views

The 633 displays important metering information at a glance on its LCD. All meter views provide various combinations of input, track, and return meters. By default, the first of three predefined meter views is shown. This view is known as the Main screen.

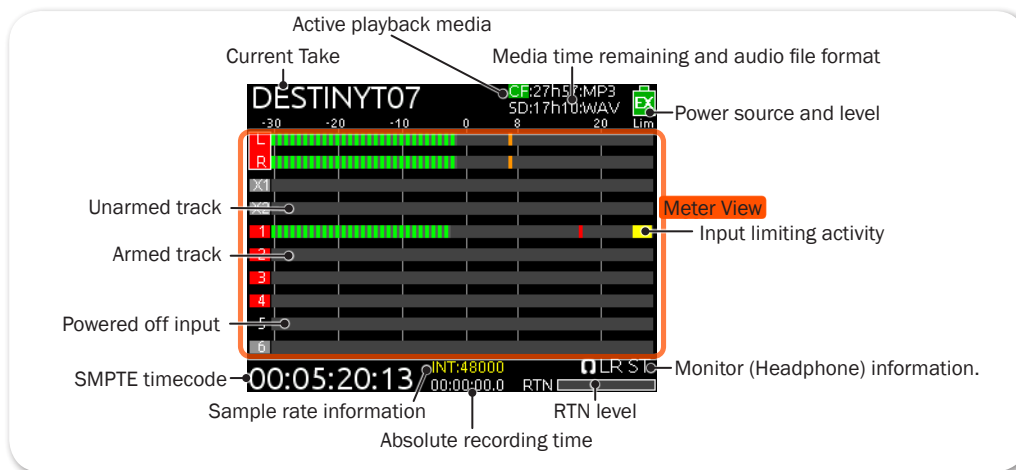

The three predefined meter views are:

- LR, X1, X2, 1-6 — This meter view (shown above) shows left, right, X1, and X2 bus tracks as well as all 6 input tracks.
- LR, X1-X4, RTN — This meter view shows left, right, X1, and X2 bus tracks, plus signal from X3, X4, and return.
- LR, 1-3 — This meter view shows left and right bus tracks as well as signal from inputs 1-3.

The following images show all three predefined meter views.

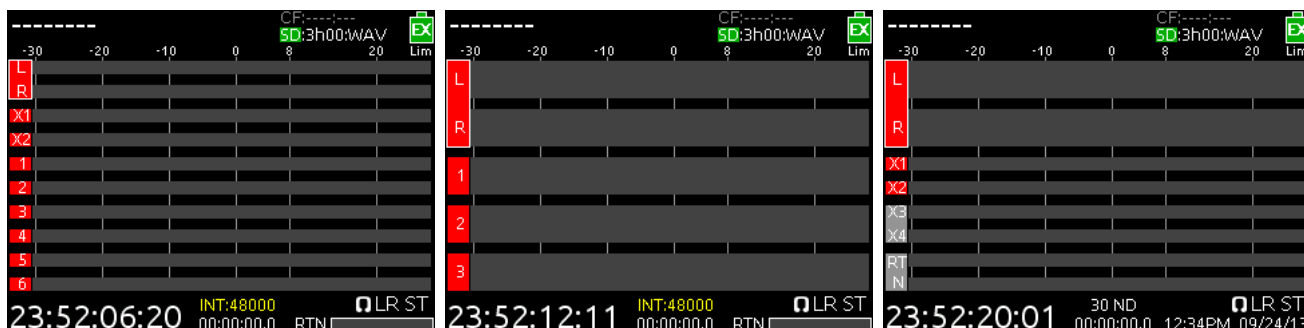

- ① *The time and date is displayed in place of the small RTN meter on the LR, X1-X4, RTN meter view. Also, a fourth configuration (not shown) with only LR and inputs 1-6 is available as a display option for meter views.*

Using Meter Views

Although the first meter view is known as the Main screen, there are other screens, which may appear on the LCD, such as the Main menu or the Input Settings screen. Regardless of what screen is visible, returning to the Main screen and its meter view is easy.

To return to the main screen at any time:

- ▶ Press the METERS button.

You can also easily switch to any of three different meter views.

To toggle between the three meter views:

- ▶ Press the METERS button. Each press of the button switches the display to the next view.

Customizing Meter Views

While the 633 provides three meter views by default, all three may be customized to display the information you deem most important. The second and third meter views may also be turned off so that only one meter view is shown as the Main screen at all times.

To customize the meter views:

1. Press MENU.
2. Turn and press the Headphone encoder to select SYSTEM > Meter Views.
3. Select the meter view you would like to change.
4. Select the display option for that meter view.

For more information on configuring the meters displayed in Meter Views, see [Configuring the Meters](#).

Accessing the Main Menu

The majority of the 633's settings are configured with the Main menu.

To access the Main menu:

- ▶ Press the MENU button.

The Main menu is made up of categories, each with its own set of sub-menu options. Turn the Headphone encoder to navigate the Main menu and press it in to select any category or sub-menu option.

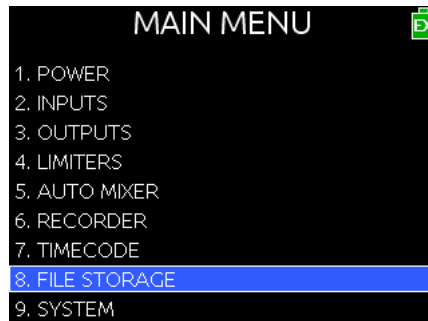

While sub-menu options are covered in more detail throughout this guide in sections related to those options, the Main menu's categories are provided with brief descriptions in the following table.

CATEGORY	DESCRIPTION
POWER	Settings related to external power sources. Also displays voltage level of External DC, Internal DC (AA), and Li-Ion batteries (labeled B1 and B2). See Configuring Power Settings for details.
INPUTS	Settings related to channel linking, phantom power, PFL modes, input to ISO routing, and input delays. See Accessing Input Settings for details.
OUTPUTS	Settings related to linking, output types or levels, output sources, output routing, and output delays. See Accessing Output Settings for details.
AUTO MIXER	Settings related to automatic mixing. See MixAssist & Dugan Automixing for details.
LIMITERS	Settings related to input and output limiters. See Limiters for details.
RECORDER	Settings to target recording media, WAV sample rate / bit depth, MP3 bit rate, and recording pre-roll time. See Accessing Recorder Settings for details.
TIMECODE	Settings related to timecode synchronization. See Timecode for details.
FILE STORAGE	Settings related to file storage and metadata. See File Storage Settings for details.
SYSTEM	Various system settings. See System for details.
CL-12	Settings related to the CL-12 linear fader controller. This sub-menu is disabled (grayed out) unless the CL-12 accessory is connected to the mixer.
QUICK SETUP	Allows user to save and recall user settings to and from SD, CF, and internal memory. Also allows resetting all settings to factory default. See Quick Setup for details.

Customizing the LCD and LEDs

Because the 633 is a portable field mixer, it may be used in a variety of environments, including some where lighting is an issue that requires adjustments to the mixer. With some System settings, you can modify the brightness levels of the LCD, the brightness levels of the LEDs, and even enable or disable the LCD Daylight mode.

To set the LCD brightness level:

1. Press the MENU button.
2. Turn and press the Headphone encoder to select SYSTEM > LCD Brightness.
3. Turn the Headphone encoder to change the value from 10 to 100%. Then press the encoder to make your selection.

By default, the LCD brightness level is set to 100%.

To set the LED brightness level:

1. Press the MENU button.
2. Turn and press the Headphone encoder to select SYSTEM > LED Brightness.
3. Turn the Headphone encoder to change the value from 5 to 100%. Then press the encoder to make your selection.

By default, the LED brightness level is set to 60%.

Using LCD Daylight Mode

The default appearance of the LCD screen is a dark theme—white text on black background. However, a lighter theme—black text on white background—is available as an alternative mode, which can make viewing in bright conditions easier. When enabled, the LCD Daylight mode may be toggled between dark and light themes.

To enable or disable LCD Daylight mode:

1. Press the MENU button.
2. Turn and press the Headphone encoder to select SYSTEM > LCD Daylight Mode.
3. Do one of the following:
 - ▶ Select On to enable.
 - ▶ Select Off to disable.

To toggle LCD Daylight mode:

- ▶ SELECT + HP: simultaneously press the SELECT and Headphone encoders.

Headphone Monitoring

The 633 provides a headphone output on its right panel, several options for headphone sources including up to 10 custom presets, plus a variety of other customizable features related to audio monitoring.

① *An unbalanced 3.5 mm TRS connection on the 633's left panel, which is primarily a multi-purpose auxiliary analog output, may also be used for headphones.*

Topics in this section include:

- ▶ Connecting Headphones
- ▶ Selecting Headphone Source
- ▶ Setting Headphone Encoder Mode
- ▶ Configuring the Headphone Preset List
 - ▶ Defining Custom Headphone Presets
 - ▶ Choosing a Favorite Headphone Preset
- ▶ Using Headphone Source Shortcuts
- ▶ Headphone Peak LED

Connecting Headphones

Connect headphones to the 1/4-inch headphone output, located on the right panel of the 633.

The 633 can drive headphones to dangerously high volumes. Turn down the headphone gain before attaching headphones or selecting a headphone source to prevent accidental high levels. The range for headphone levels may be set from OFF, -42 dB to +20 dB.

To adjust Headphone gain:

- ▶ Turn the Headphone encoder. The gain value will be displayed in the lower-right corner of the Main screen next to the Headphone Source icon.

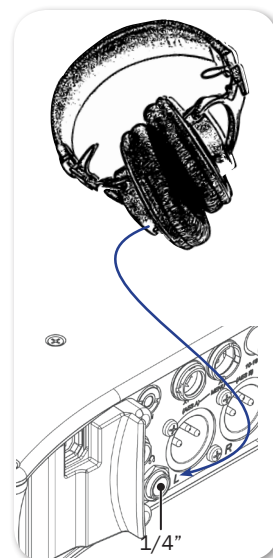

Selecting Headphone Source

The default list of headphone presets consists of six predefined headphone sources and 10 customizable presets. The predefined headphone sources are:

HP SOURCE	DESCRIPTION
LR ST	Master bus in stereo.

HP SOURCE	DESCRIPTION
LR Mono	Master bus summed mono to both ears.
L Mono	Left channel of master bus sent to both ears.
R Mono	Right channel of master bus sent to both ears.
LR MS ST	Mid-side stereo - master bus decoded MS stereo to headphones. This is not to be used if the inputs are already linked as an MS pair.
X1X2	Aux bus in stereo.

To select a headphone source:

1. Press the Headphone encoder to display the list of available sources.
2. Turn the encoder to change the headphone source. Options include: LR ST, LR Mono, L Mono, R Mono, LR MS ST, X1X2, and HP Preset (1) through HP Preset (10).
The headphone source changes immediately as it is highlighted in the list.
3. Press the encoder to close the list, or wait two seconds and it will close on its own. The chosen headphone source is displayed in the lower-right corner of the Main screen next to the Headphone Source icon.

Setting Headphone Encoder Mode

The default functionality of the Headphone encoder can be reversed so that the Headphone encoder must be pressed before turning to adjust the headphone volume, and headphone source can be selected by simply turning the Headphone encoder.

To set Headphone Encoder mode:

1. Press the MENU button.
2. Turn and press the Headphone encoder to select SYSTEM > Headphone Encoder Mode > Preset/Vol. By default, this mode is set to Vol/Preset.

Configuring the Headphone Preset List

Presets can be excluded from this list to make preset selection simpler.

To edit the Headphone Preset list:

1. Press the MENU button.
2. Turn and press the Headphone encoder to select SYSTEM > Headphone Preset List.

The Headphone Preset List will be displayed; presets with a blue background are visible, and presets with a black background are hidden.

3. Turn and press the Headphone encoder to toggle visibility of each preset.

Defining Custom Headphone Presets

In addition to the six predefined headphone sources, 10 options are available as custom headphone presets.

To customize a headphone preset:

1. Press the Headphone encoder to display the list of available sources.
2. Turn the encoder to choose one of the 10 customizable preset options, such as HP Preset(1).
3. Slide the MIC/TONE switch left or right.

The Headphone Preset Editing screen appears.

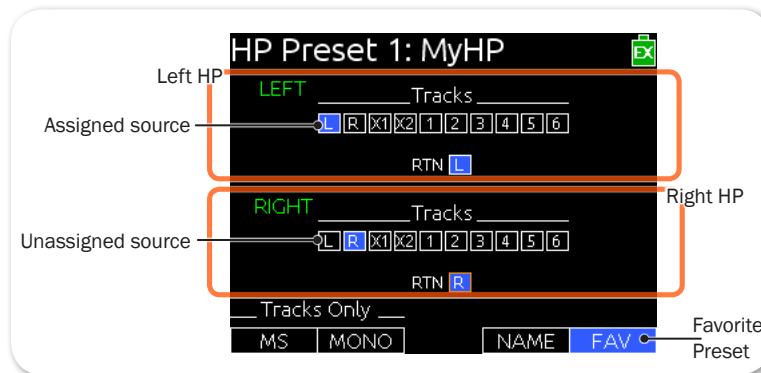

4. Turn the Headphone encoder to move the orange highlight to routing options.
 5. Press the Headphone or Select encoder to change the selected source between Off (black) and Assigned (blue).
- ① *ISO sources will follow pre- or post-fade based on Input to ISO Routing settings.*
6. (Optional) Do any of the following:
 - ▶ Slide the MIC/TONE switch left to toggle MS decoding for this headphone preset.
 - ▶ Slide the MIC/TONE switch right to toggle mono summing for this headphone preset (All active sources will be summed into both headphone channels). This should not be used if inputs are already linked MS.
 - ▶ Slide the RTN/FAV switch left to name the headphone preset.
 - ▶ Slide the RTN/FAV switch right to toggle the favorite status of this headphone preset.
 7. Press MENU or METERS to save the preset and exit the Headphone Preset Editing screen.
- ① *Only one preset at a time can be set as a favorite. Marking a preset as favorite will remove the favorite status of all other presets.*

Choosing a Favorite Headphone Preset

A single headphone preset can be designated as a favorite. This favorite headphone preset can be quickly accessed via the front panel. The following procedure assumes the Headphone Encoder Mode is set to Preset/Vol. For more information, see *Setting Headphone Encoder Mode*.

To choose a predefined Headphone preset as favorite:

1. Press the Headphone encoder to display the list of available sources.
2. Turn the Headphone encoder to highlight the predefined preset you want. Options include: LR ST, LR Mono, L Mono, R Mono, LR MS ST, and X1X2.
3. Slide the RTN/FAV switch right to set the highlighted Headphone preset as your new favorite.

Using Headphone Source Shortcuts

There are two headphone monitor shortcuts on the 633: RTN and the headphone source set as favorite.

To monitor the favorite headphone source:

- ▶ Slide the RTN/FAV switch to the right.

To monitor RTN:

- ▶ Slide the RTN/FAV switch to the left.

RTN will be displayed in the lower-right corner of the Main screen next to the Headphone Source icon. For meter views that do include a large RTN meter, the date and time is displayed under. For meter views that do not include a large RTN meter, a smaller RTN meter is displayed under the Headphone Source icon.



Headphone Peak LED

The Headphone Peak LED, located just left of the Headphone encoder, illuminates red to indicate headphone output is approaching clipping level. Monitoring without a visual indication of headphone clipping can mislead a sound mixer into thinking the output or return feeds are distorted.

Power

The 633 features a quad-powering configuration, which utilizes different powering options, such as external DC power, or it may be powered by five AA batteries. Two rear mounts enable the 633 to be powered by Sony L-Series batteries.

The 633 also incorporates exclusive PowerSafe™ technology with smart sensing of available power sources, front panel power warning indication, and an integrated 10-second power reserve that safely stops recording and shuts down in the event of a power loss.

Topics in this section include:

- ▶ Powering the 633
 - ▶ Using External Power
 - ▶ Using Battery Power
- ▶ Voltage Ranges and Thresholds
- ▶ Configuring Power Settings
- ▶ PowerSafe
- ▶ QuickBoot
- ▶ Forcing Power Off (Optional)
- ▶ Power Consumption

Powering the 633

The 633 operates on either external DC power or battery power.

To turn on the 633:

- ▶ Flip the Power switch to the ON position.

The Power LED illuminates yellow then green. The Sound Devices splash screen appears briefly on the LCD, and then the Main screen is displayed.

As part of the Main screen, the LCD displays a DC voltage indicator in the form of a battery icon that indicates the level and type of the power source currently in use.

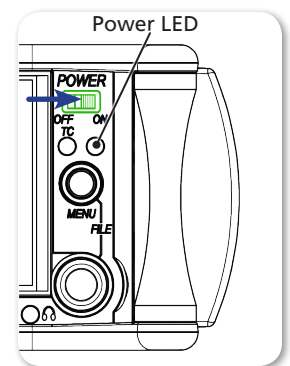

Normal Voltage
(Green)



Warning Voltage
(Yellow)



Low Voltage
(Orange)



Critical Voltage
(Red)

Using External Power

The 633 uses only one power source at a time, with external DC power taking precedence over battery power. The order of precedence for power sources is: DC power (EX) > L-Series battery (B1) > L-Series battery (B2) > AA batteries (INT)

Following after these power sources is PowerSafe circuitry and its 10-second power reserve, before shutdown.

To connect an external power source:

- ▶ Plug a DC power source (not included) into the 10-18 VDC input on the right panel.

① *Pin-4 of the locking, Hirose connector is positive (+) and pin-1 is negative (-).*

Using Battery Power

The 633 uses up to two L-Series (Li-Ion) batteries and/or six AA batteries as a backup to external power. Several power capacities are available in the L-Series battery type, ranging from 1000 mAh to 7000 mAh. Larger amp-hour batteries provide more run time. Alkaline AA batteries may be used with the 633; however, NiMH (or 1.5V Lithium) batteries are the preferred type because they provide for longer run times compared to Alkaline batteries.

To mount L-Series batteries:

1. Place the 633 on a stable surface.
2. Position the battery so the two terminals on the battery line up with the tips of the two pins on the rear panel of the 633.
3. Press the battery against the unit and slide the battery onto the pins. The battery retainer clip will spring up with a satisfying click to let you know the battery is secure.

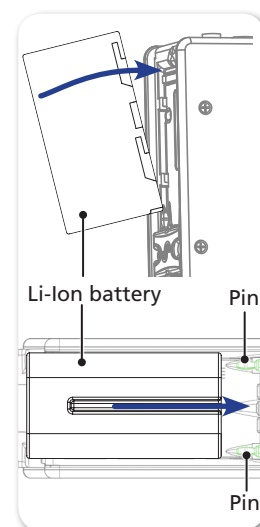

To insert AA batteries:

1. Unscrew the battery cap (counter-clockwise).
2. Insert five AA NiMH batteries (not included) into the battery tube. Orient the batteries with the positive (+) end facing in and the negative (-) end facing out.

① *With external power connected, depleted AA batteries may be removed from the 633 and replaced with new ones without affecting operations.*

Voltage Ranges and Thresholds

The DC voltage indicator provides power status information based on the External DC Reference parameter, which defines the voltage range and warning threshold for external DC power sources. Setting the External DC Reference to a value appropriate for the type of external power being used maximizes runtime with that source.

For instance, the indicator appears solid green when the active power source is

full or operating within the defined high voltage range. As the voltage depletes, the indicator's color changes from green to yellow (warning) to orange (low) and to red (critical), based on the external power source's range and threshold, as shown in the following table:

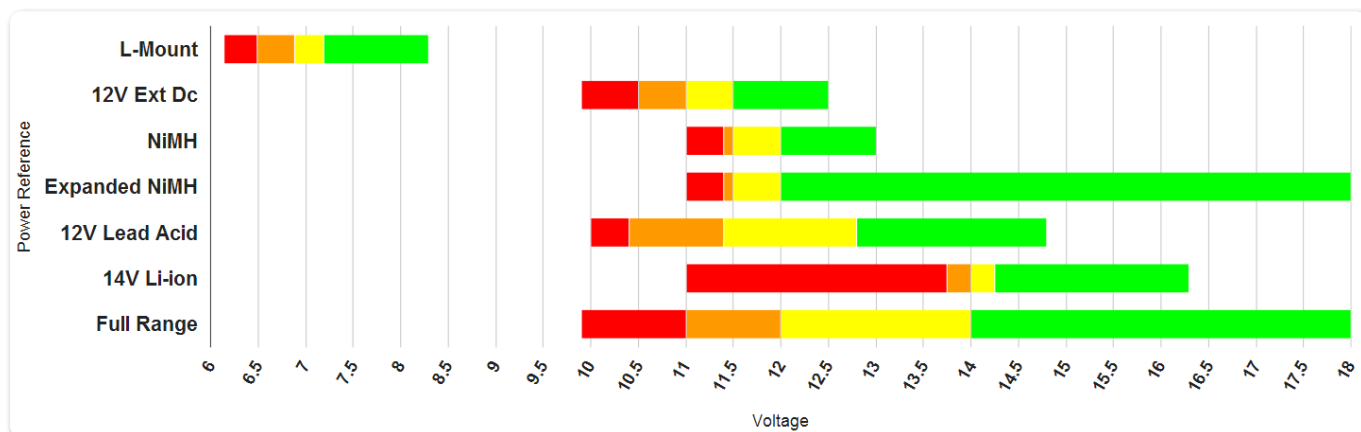

If the active power source is removed or its voltage drops to the critical threshold, the 633 switches to alternative battery power or shuts down, according to how its External DC Loss parameter is configured in the Power settings.

The DC voltage indicator flashes red when there are no other connected backup power sources remaining with adequate voltage. When all power sources are depleted, PowerSafe shutdown occurs automatically.

Configuring Power Settings

The 633 allows you to configure the type of external power source and what the mixer should do in the event of an unintentional power loss.

To configure Power settings:

1. Press the MENU button.
2. Turn and press the Headphone encoder to select POWER.

The Power screen appears, from which numeric voltage levels of all connected power sources may be monitored. Disconnected power sources have a black background and no voltage level. The power source currently in use has a thick white border.

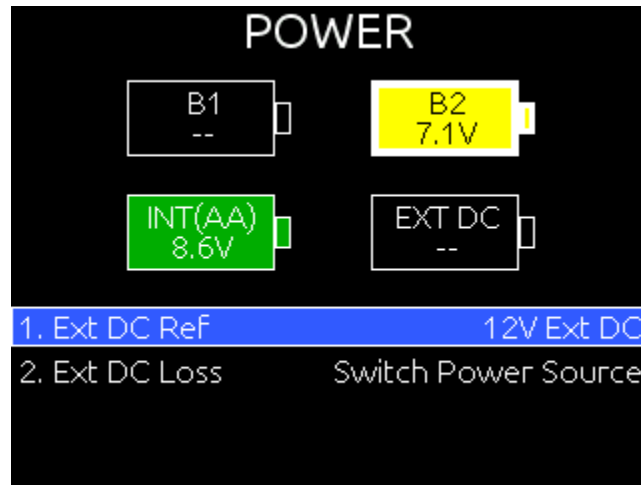

3. Adjust the settings based on the following table:

PARAMETER	DESCRIPTION	OPTIONS
Ext DC Ref	Calibrates the power level indicator according to the type of external DC source. By default, this is set to 12V Ext DC. Select the appropriate option for the external DC power.	<ul style="list-style-type: none"> • 12V Ext DC • NiMH • Expanded NiMH • 12V Lead Acid • 14V Li-ion • Full Range
Ext DC Loss	Choose what action the 633 should take when external power is removed or voltage drops below the set threshold. By default, this is set to Switch Power Source.	<ul style="list-style-type: none"> • Switch Power Source • Shut down
	<p>① <i>If the Ext DC Loss setting is configured to Switch Power Source when external power is lost, but there are no internal batteries with adequate voltage in the 633, then automatic PowerSafe shutdown will occur.</i></p>	

PowerSafe



When all connected power sources are depleted or power is lost unexpectedly, the PowerSafe™ circuitry activates. The 633 displays a warning, stops any active recordings, finishes writing files, and shuts down. The PowerSafe battery powers the 633 during this time. This feature ensures that files are protected even in the event of unexpected power loss.

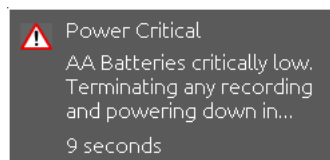

① *The PowerSafe battery recharges from the active power source only when the 633 is powered on.*

QuickBoot™ circuitry is enabled for two hours after the 633 is powered down. During this time, the 633 can turn on and start recording in less than two seconds. Each time the 633 is turned on and off, the two-hour timer is reset. Beyond the two-hour mark, QuickBoot is deactivated, so powering up results in a normal, slightly longer boot-up process.

Within the two-hour time frame, while QuickBoot is enabled, the internal Timecode (TC) generator continues to be active and the TC LED on the front panel of the 633 blinks every two seconds.

Forcing Power Off (Optional)

In the unlikely event you need to manually force a complete shutdown of the 633, by-passing the PowerSafe and QuickBoot features, do the following:

To force power off:

1. Slide the Power button to the left.
2. Press and hold the MENU button for 5 seconds.

After the 633 is manually powered off, the QuickBoot is reset and the TC LED no longer flashes.

① *Manual shutdown will turn off the timecode backup battery, requiring timecode to be rejammed and user bits to be reset upon next power up.*

Power Consumption

Many factors influence the rate at which the 633 uses battery power (current draw). The following list highlights the larger current drawing functions.

- Microphone powering — The main source of extra 633 current draw. 48 V Phantom can draw a large amount of current depending on what model microphone is used. Two identical phantom powered microphones draw twice as much current as one.
- Audio Recorder — The recorder, whether in record or playback, draws extra current. Higher sample rate WAV recordings draw more current during recording.
- Digital Outputs — Disable digital outputs in the Main menu when they are not needed since they draw additional current.
- Output level — Higher output levels into multiple, low-impedance inputs increases current draw.
- Headphone Output circuit - High headphone output levels and low impedance headphones increase current draw.
- LED and LCD Brightness — Decrease LED and LCD brightness to reduce current draw.

Inputs

The 633 has three full-featured audio inputs on XLR-3F connectors, and three additional line-level inputs on TA3 connectors.

Inputs may be used as either balanced or unbalanced connections. There is no change in gain between unbalanced and balanced connections into the 633.

① *For unbalanced connections, tie pin-3 to pin-1 of the XLR-3M connector of the cable.*

Topics in this section include:

- ▶ Physical Input Controls
- ▶ Activating an Input
- ▶ Accessing the Input Setting Screens
 - ▶ Setting Input Source
 - ▶ Setting Input High-Pass Filters
 - ▶ Setting L, R, X1, and X2 Routing
 - ▶ Using a Track Name Shortcut
 - ▶ Inverting the Phase
- ▶ Adjusting Trim and Fader Controls
- ▶ Adjusting Pan
- ▶ Accessing Input Settings
 - ▶ Configuring Linking
 - ▶ Configuring Phantom Voltage
 - ▶ Configuring the PFL Toggle Mode
 - ▶ Configuring Input to ISO Routing
 - ▶ Configuring Input Delay

Physical Input Controls

On the front panel, there are sets of controls related to inputs, such as pans, faders, and trims.

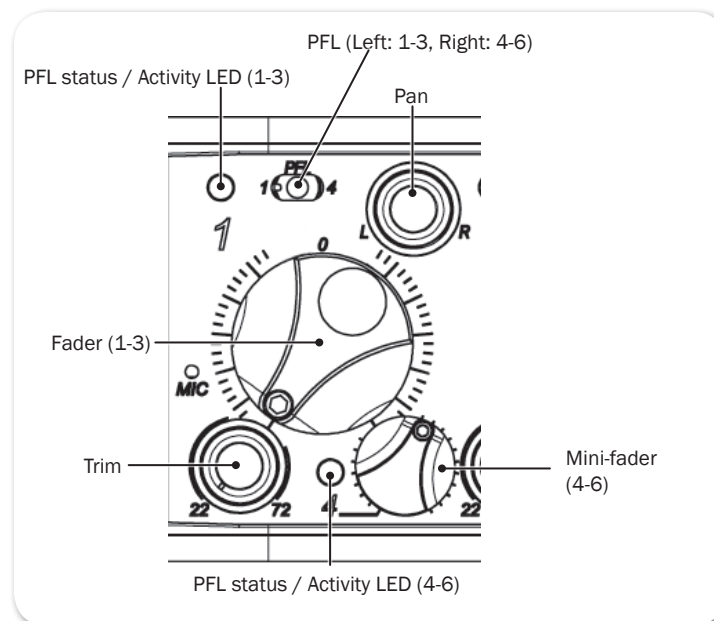

The Trim, Pan, and Mini-fader controls may be pressed to retract the controls into the front panel when not in use.

CONTROL	DESCRIPTION
PFL	Pre-Fade Listen (PFL) switch. Solos input signal in headphone monitor and displays Input Settings screen. ① <i>PFL monitoring only affects the headphone monitor. It does not affect audio sent to the outputs or internal recorder.</i>
Fader 1-3	Adjusts fader level for inputs 1-3.
Trim 1-3	Activates inputs 1-3 and adjusts trim level for inputs 1-3. Trim level for inputs 4-6 are controlled from their respective Input Settings screens.
Mini-fader 4-6	Activates inputs 4-6 and adjusts fader level for inputs 4-6.
Pan	Controls the Left/Right balance of the input signal to the stereo master bus. Inputs 4-6 are routed to the L/R mix via their respective Input Settings screens.
PFL Status / Activity LED	<ul style="list-style-type: none"> • Green: Signal present on input (pre-fade). • Red: Signal clipping on input (pre- and post-fade). • Amber: Limiter engaged on input (pre- and post-fade). • Blinking Yellow: Input soloed (PFL) in headphone monitors.

Activating an Input

The 633 has three dedicated Trim controls on the front panel.

To activate inputs 1-3:

1. If the Trim control for an Input is recessed, push it in and it will pop out.
2. Turn the Trim control clockwise until it clicks to activate the input.

① *The input is deactivated whenever the Trim control for that input is fully rotated counter-clockwise.*

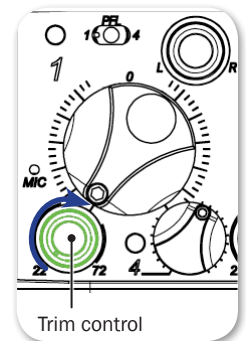

To activate inputs 4-6:

1. If the Mini-fader control for an Input is recessed, push it in and it will pop out.
2. Turn the Mini-fader control clockwise until it clicks to activate the input.

① *The input is deactivated whenever the Mini-fader control for that input is fully rotated counter-clockwise.*

Accessing the Input Setting Screens

Each input has its own Input Settings screen. This screen provides access to the input's settings, such as input source, high-pass filter, and track routing, and also displays information about the input's gain and meter levels.

To access an Input Settings screen and PFL (solo) the input:

1. Ensure the chosen input has been activated.
 2. Slide the PFL switch to the left for inputs 1-3 or right for inputs 4-6.
- ① *Step 1 is based on factory defaults. If sliding the switch to the left does not display the Input Settings screen, then the 633's PFL Toggle Mode is not set to its 6-channel default. When the PFL Toggle Mode is set to only 3 channels, you must slide the PFL switch to the right instead of the left since sliding to the left is used to activate PFL without leaving the Main screen.*

When the Input Settings screen is accessed, the headphone source is changed to PFL for the chosen "solo" input. The headphone source returns to its previous source after the Input Settings screen is exited.

- ① *Hold the Select encoder down while sliding the PFL switch to access the Input Settings screen without altering the headphone source. This behavior is reversed when PFL Toggle Mode is set to 3 channels.*

All Input Settings screens share some common elements, such as channel name, channel number, level meter, trim and/or fader gain values, X1/X2 routing, HPF, and source selection.

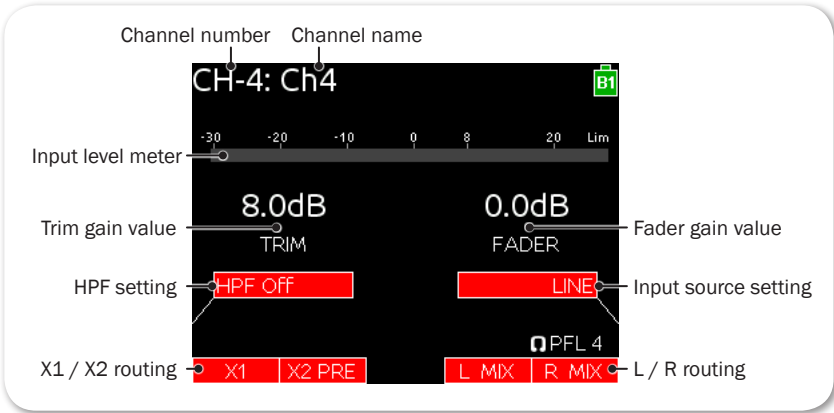

Items displayed on the bottom half of the screen are adjusted by the physical controls that they are near: Select encoder, MIC/TONE switch, RTN/FAV switch, and Headphone encoder.

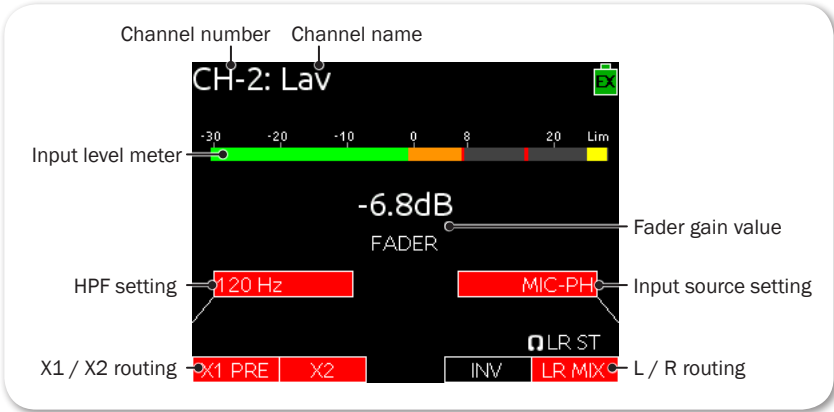

Input Settings screen for input 2 includes an INV option for inverting phase. For

more information on phase inversion, see *Inverting the Phase*.



Inputs 4-6 allow separate routing to L and R tracks, since these inputs do not have pan controls.



Setting Input Source

Each input channel may be configured to receive signal from a unique source.

To set an input's source:

1. Slide the PFL switch left to access the Input Settings screen for that input.
 2. Press the Headphone encoder to display the list of available input sources. Options include:
 - OFF – Use to deactivate an input without having to change trim.
 - MIC – Use for dynamic microphones or mic-level sources.
 - MIC-PH – Use for microphones requiring phantom power.
 - LINE – Use for analog line level sources.
 - LINE-PH – Use for phantom-powered condenser microphones. Provides 48V or 12V phantom power, but at a line-level gain range. Useful in high sound-pressure-level environments.
 - AES42 – Use for digital AES42 (Mode 1) microphones.
 - AES3 – Use for a digital AES3 source.
 3. Turn the Headphone encoder to select an input source.
- Not all types of sources are available for each channel:

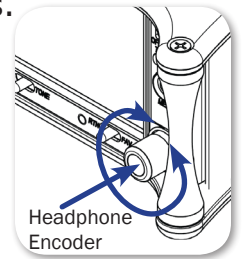

INPUT	TYPES
Channel 1	OFF, MIC, MIC-PH, LINE, LINE PH, AES 42, AES 3
Channel 2	OFF, MIC, MIC-PH, LINE, LINE PH ① <i>AES 42, AES 3 is conditionally available on Channel 2 only if Channel 1 is already set to AES 42 or AES 3</i>
Channel 3	OFF, MIC, MIC-PH, LINE, LINE PH
Channel 4	OFF, LINE
Channel 5	OFF, LINE
Channel 6	OFF, LINE

4. Slide the PFL switch to the left again to return to the Main screen.

Setting Input High-Pass Filters

Each input features a high-pass filter (HPF), which are useful for removing excess low frequency energy from audio signals, such as wind noise. For more audio applications, engaging high-pass filter is beneficial, because audio information below 100 Hz is rarely used, especially for speech reproduction.

The filter is off by default but may be adjusted from 80Hz to 240Hz in 10Hz increments.

To adjust an input's high-pass filter:

1. Access the Input Settings screen for the input to be adjusted.
2. Push the Select encoder. The HPF label will become orange to indicate adjustment.
3. Turn the Select encoder to adjust the value.
4. Press the Select encoder (or wait 2 seconds) to exit adjustment mode. The new value is saved, and the HPF label will become red again.

① *When RECORDER > Sample Rate is set to 192k, the HPF options are off and 50 Hz.*

The 633's HPF circuit features an adjustable corner (-3 dB) frequency over a range from 80 to 240 Hz. Below 80 Hz, the filter's slope is 12 dB/octave. At higher corner frequency settings, the slope is 6 dB/octave. The purpose for this compound slope is to give additional roll-off at the 80 Hz setting to reduce wind noise and low frequency rumble. The higher settings may be used to counteract the proximity effect of directional microphones where a more gentle slope is preferred.

The 633's HPF circuit is unique because of its placement before any electronic amplification. Most mixers' HPF circuits are placed after the microphone preamplifier, such that all of the low-frequency signals get amplified. By virtue of the 633's circuit cutting the low-frequency signals before amplification, higher headroom is achieved in the presence of signals with significant low-frequency energy.

When possible, attempt to equalize at the sound source with microphone selection, placement, windscreens, and on-board microphone filtering. Many microphones have on-board high-pass filters. Use the high-pass filters on the 633 in conjunction with the microphone's filter to increase the filter's slope.

Setting L, R, X1, and X2 Routing

Routing of inputs to L, R, X1, and X2 tracks can be adjusted quickly from the Input Settings screen. An input's routing to a track is indicated on the Input Settings screen with labels in the bottom left (X1/X2) and bottom right (L/R) of the LCD. A red label indicates the input is routed and a black label indicates the input is not routed.

To route inputs 1-3 to L and R tracks:

1. Access the Input Settings screen.
 2. Slide the RTN/FAV switch right to toggle L and R track routing together.
- ① *Independent assignment of signal to the L and R tracks for inputs 1-3 is adjusted using the input's dedicated Pan control.*

To route inputs 4-6 to L and R tracks:

1. Access the Input Settings screen.
2. Slide the RTN/FAV switch right to toggle track R routing, or left to toggle track L routing.

To route any input to X1 and X2 tracks:

1. Access the Input Settings screen.
 2. Slide the MIC/TONE switch right to toggle X2 routing, or left to toggle X1 routing.
- ① *Slide the MIC/TONE switch right or left again for an additional routing ("PRE"), which is available for X1 and X2 routes. This indicates a pre-fader routing.*

Using a Track Name Shortcut

Track Names are stored in the metadata of each recorded file. The following list displays the default track names:

Track L: MixL	Track 1: Ch1	Track 4: Ch4
Track R: MixR	Track 2: Ch2	Track 5: Ch5
Track X1: Aux1	Track 3: Ch3	Track 6: Ch6
Track X2: Aux2		

An input's track name can be quickly edited from the Input Settings screen.

To edit an input's track name from the Input Settings screen:

1. Access the Input Settings screen for the input to be adjusted.
 2. Hold the same switch (or shortcut) used to access the Input Settings screen for 2 seconds. (For example, if the Input Settings screen was accessed by sliding the PFL switch to the left, then hold the same PFL switch left for 2 seconds). The on-screen keyboard will appear allowing entry of a text value.
 3. When finished, slide the RTN/FAV switch right (or Enter on attached USB keyboard) to set the track name.
- ① *Track names can also be edited from the Take List. For details, refer to [Take List](#)*

Overview.

The way track names are displayed in meter views may vary, depending on a system setting called Track Names in Meters. For more information, see *Configuring the Meters*.

Inverting the Phase

Phase inversion is available only on input 2 of the 633. Phase inversion (or polarity reversal) is used to compensate for incorrectly wired, balanced cables, to prevent signal cancellation when a source is dual-mic'd from opposite directions, or to reverse left/right with microphones in a mid-side (MS) configuration.

To invert the phase of input 2:

1. Slide the PFL switch left to access the Input Settings screen for input 2.
2. Slide the RTN/FAV switch to the left. The INV label on screen will illuminate red to indicate phase inversion.

Adjusting Trim and Fader Controls

The gain of an input is adjusted by two controls, Trim and Fader. This two-stage architecture is identical to the topology of large mixing consoles and provides a great deal of control. Trim is often thought of as a coarse gain control and the Fader as the fine gain control.

The Fader is the primary control used while mixing, and it affects the level of input signal routed to all post-fade destinations. Use the Fader control to make fine gain adjustments. The Fader control can be attenuated from off (at full counter-clockwise position) to +16dB above the set trim level (at full clockwise position). Operate input faders at or near 0dB, the unity gain (12 o'clock) position to optimize gain structure for the best performance.

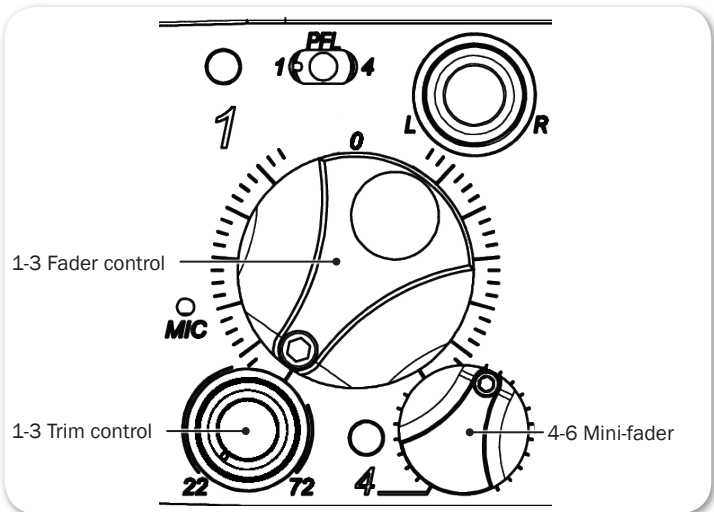

To adjust trim and fade:

1. Access the Input Settings screen for the chosen input.
2. Do one of the following:
 - ▶ For inputs 1-3: Set Fader control to 0 dB, the unity gain position.
 - ▶ For inputs 4-6: Set Mini-fader control to 0 dB. If the Mini-fader control is recessed, push it in and it will pop out.
3. Do one of the following:
 - ▶ For inputs 1-3: Adjust the input’s Trim control clockwise until optimal level is achieved on metering and in headphones.
 - ▶ For inputs 4-6: Access the Input Settings screen for the input chosen from 4-6, and then rotate the SELECT encoder to adjust the trim level. The gain value is displayed on the Input Settings screen.

For inputs 1-3 analog mic level is adjustable from +22 dB to +72 dB of gain. Analog line level is adjustable from -30 dB to +16 dB, and AES digital trim level is adjustable from -30 to +16 dB.

Adjusting Pan

The Pan pot routes inputs to the left (L) and right (R) channels of the stereo Master Bus. The Pan pot has a detent in its center (12 o’clock) position.

To adjust an input’s pan (1-3):

- ▶ Turn the Pan pot.

After setting the pan, press the Pan pot in to recess the control when not in use.

① Inputs 4-6 are routed directly to L and R channels of the stereo Master Bus from their respective Input Settings screens.

Accessing Input Settings

The Main menu has a sub-menu of settings related to inputs. These may be used to customize the configuration of the 633.

To access Inputs sub-menu:

1. Press the MENU button.
2. Turn and press the Headphone encoder to select INPUTS.

SUB-MENU	DESCRIPTION	OPTIONS
Ch 1-2 Linking	Sets channel linking for input pair 1-2	<ul style="list-style-type: none"> • Unlinked • 1-2 • 1-2MS <p><i>① MS stands for Mid-Side.</i></p>

SUB-MENU	DESCRIPTION	OPTIONS
Ch 5-6 Linking	Sets channel linking for input pair 5-6	<ul style="list-style-type: none"> • Unlinked • 5-6 • 5-6MS
Phantom Voltage	Globally adjusts voltage level of phantom power (on all inputs which have phantom power enabled).	<ul style="list-style-type: none"> • 48V • 12V
PFL Toggle Mode	Globally alters the behavior of PFL switches.	<ul style="list-style-type: none"> • 6ch • 3ch
Input to ISO Routing	Sets pre- or post-fade status of each input's (1-6) routing to its ISO track.	<ul style="list-style-type: none"> • Prefade • Postfade
Input Delays	Sets delay for each input's signal up to 30 ms in 0.1 ms increments.	<ul style="list-style-type: none"> • 0.0 - 30.0 ms

Configuring Linking

Pairs of adjacent inputs (1-2 and 5-6) may be linked as standard stereo pairs or as a Mid-Side (MS) stereo pair. Linked inputs share a common fader. The pan control of the odd input controls the balance of both signals to the L-R and X1-X2 tracks. The following illustration indicates which controls are active and what those controls do when inputs are linked.

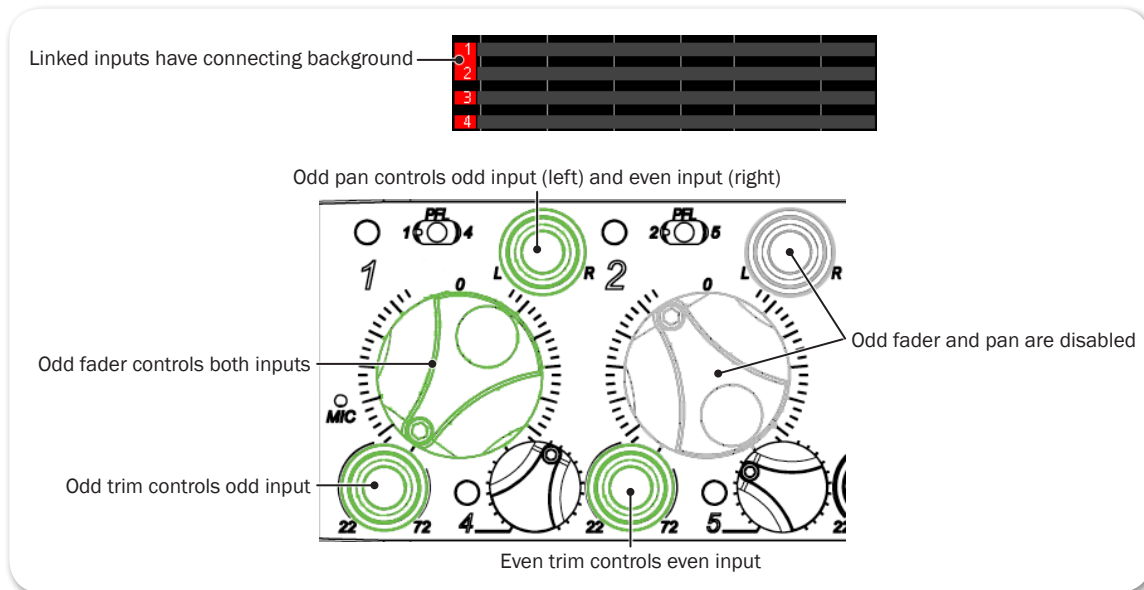

To configure channel linking:

1. Press the MENU button.
2. Turn and press the Headphone encoder to select INPUTS, then the sub-menu option corresponding to the input pair: Ch 1-2 Linking or Ch 5-6 Linking
3. Turn and press the Headphone encoder to set linking, indicated by pairs. Options include: Unlinked, Linked (pair), or Linked (pair) MS.

For instance, selecting 1-2 configures channel linking for input pair 1 and 2.

Selecting 5-6 MS, configures mid-side linking for input pair 5 and 6.

Mid-Side Linking

When input pairs are linked MS, the odd channel is used for the Mid signal and the even channel is used for the Side signal. To produce a stereo signal from an MS configuration, the signal from both microphones must be processed.

Mid-side matrixing is a method for processing audio signal from a cardioid microphone and a bidirectional microphone into a stereo signal. The cardioid microphone is the Mid signal and connects to the odd input, and the bidirectional microphone is the Side signal and connects to even input. The cardioid microphone is pointed at the sound source, and the bidirectional microphone is oriented sideways—positioned with its capsule as near as possible to the cardioid microphone's capsule. The diagram shows the relative polar patterns of microphones in an MS configuration.

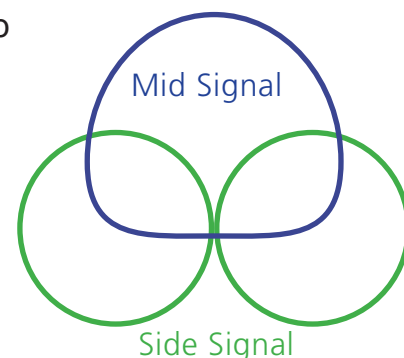

Configuring Phantom Voltage

Phantom powering is a fixed DC voltage of either 12 or 48 volts. This voltage is resistively applied to pin 2 and pin 3 of an input's XLR-3F connector, relative to pin 1. In this configuration, there is no voltage difference between signal pins 2 and 3.

On the 633, the factory default sets phantom power voltage to 48 volts, but that may be changed.

To configure phantom voltage:

1. Press the MENU button.
2. Turn and press the Headphone encoder to select INPUTS > Phantom Voltage.
3. Turn the Headphone encoder to change the setting. Options include: 48V or 12V.

This setting globally adjusts the voltage level of phantom power on all inputs with phantom power enabled.

Configuring the PFL Toggle Mode

There are three PFL switches on the front panel of the 633. The first applies to inputs 1 and 4, the second to inputs 2 and 5, and the third is for inputs 3 and 6. By default, access to PFL and the Input Settings screen for inputs 1-6 can be achieved with one hand. This is called 6-Channel mode. While in 6-Channel mode, sliding a PFL switch either right or left will engage PFL on the chosen in-

put and display its Input Settings screen. For instance, slide the first PFL switch left to view the Input Settings screen and activate solo PFL on input 1. Slide the same switch right for input 4.

① *The input's PFL Status/Activity LED flashes yellow when PFL is engaged, and the PFL number will appear in the lower right corner of the Input Settings screen (next to a headphone icon).*

However, the PFL switches on the 633 may be configured to focus operation solely on inputs 1-3, while leaving inputs 4-6 accessible via a button combination. This configuration option is called 3-Channel mode.

To enable 3-Channel PFL Toggle mode:

1. Press the MENU button.
2. Turn and press the Headphone encoder to select INPUTS > PFL Toggle Mode > 3ch.

① *The INPUTS > PFL Toggle Mode submenu is disabled when the CL-12 linear fader controller is connected to the mixer.*

To engage solo PFL for inputs 1-3 while in 3-Channel mode:

- ▶ Slide PFL switch left.

To access inputs 1-3 Input Settings screens while in 3-Channel mode:

- ▶ Slide PFL switch right.

To engage solo PFL for inputs 4-6 while in 3-Channel mode:

- ▶ SELECT + PFL: press SELECT encoder and slide PFL switch left.

To access inputs 4-6 Input Settings screens while in 3-Channel mode:

- ▶ SELECT + PFL: press SELECT encoder and slide PFL switch right.

Configuring Input to ISO Routing

By default, each input is routed to its associated ISO track pre-fade (The fader does not affect the signal on the ISO track). This routing can be configured (on a per-input basis) to be post-fade (The fader does affect the signal on the ISO track).

To configure Input ISO Routing:

1. Press the MENU button.
2. Turn and press the Headphone encoder to select INPUTS > Input to ISO Routing.
3. Turn and press the Headphone encoder to select the desired input routing

and edit its value.

4. Turn and press the Headphone encoder to select Prefade or Postfade.

① *Input to ISO Routing for inputs 1-6 also affects the pre- or post-fade status of those inputs' routing to AES digital outputs.*

Configuring Input Delay

Input delay is applied before the signal is sent to the recorder and outputs. Each input can be delayed up to 30ms.

To configure input delay:

1. Press the MENU button.
2. Turn and press the Headphone encoder to select INPUTS > Input Delays.
3. Turn and press the Headphone encoder to select the input. The background of the value will become orange to indicate the value is being edited.
4. Turn and press the Headphone encoder to set the new delay value for the chosen input.

Outputs

The 633 offers multiple outputs with flexible configuration. Whether you need to send the LR mix to multiple cameras, the camera RTN feed via IFB, or AES digital signals, the 633 is up to the task.

The right panel features master LR bus transformer balanced outputs via two XLR-M connectors, which can alternatively be used to send up to four signals (two pairs) of AES digital, two active balanced Aux outputs via TA3, an additional unbalanced stereo Aux output via a 3.5 mm unbalanced connector.

Topics in this section include:

- ▶ Output Connections
- ▶ Adjusting Output Gain
- ▶ Accessing Output Settings
- ▶ Configuring Output Linking
- ▶ Setting Output Type and Nominal Level
- ▶ Output Routing
 - ▶ Accessing AES Output Routing Screen
 - ▶ Accessing Aux (X1 - X4) Routing Screens
- ▶ Configuring Playback to Outputs
- ▶ Adjusting Output Delay
- ▶ Sending Tone to Outputs

Output Connections

On the 633, the Left and Right XLR-M connectors are each transformer balanced from separate windings. This improves isolation from potential interference. The master outputs are capable of driving long cable runs. Aux outputs X1 and X2 use active-balanced TA3 connections. The X3/X4 output (3.5mm TRS) and Headphone output (1/4" TRS) are all unbalanced stereo connections.

① *See Specifications chapter for full details on the electronic specifications of the various output connections.*

Adjusting Output Gain

Output gain is adjusted from the Output meter view.

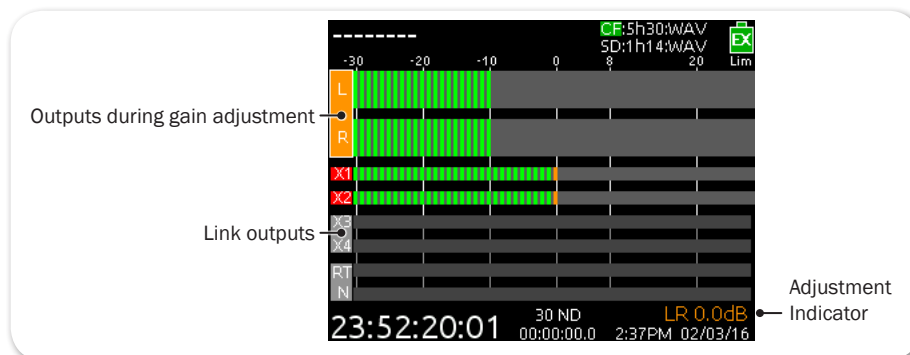

To adjust output gain:

1. Press the METERS button repeatedly until the Output meter view is visible.
 - ① *If the Output Meters view is not available, it must be selected as one of the three views in main menu option SYSTEM > Meter Views.*
2. Turn and press the SELECT encoder to choose an output and enter gain adjustment. The background color of the chosen output becomes orange, and the output gain value is displayed in the lower-right corner of the screen.
3. Turn the SELECT encoder to adjust the output gain.
4. Press the SELECT encoder or wait two seconds to exit Gain Adjustment mode.
 - ① *Output gain adjustments do not affect tone signal from the 633's tone generator.*

Accessing Output Settings

The Main menu has a sub-menu of settings related to outputs. These may be used to customize the configuration of the 633 outputs.

To access Outputs sub-menu:

1. Press the MENU button.
2. Turn and press the Headphone encoder to select OUTPUTS.

SUB-MENU	DESCRIPTION	OPTIONS
Linking	Choose which output pairs are linked for the purpose of arming and level adjustment. By default, linking is set to LR, X1, X2. Commas represent no linkage, so LR, X1, X2 means L and R are linked, while X1 and X2 are not.	<ul style="list-style-type: none"> • LR, X1X2 • LR, X1, X2 • L, R, X1X2 • L, R, X1, X2
XLR-L Out	Select the nominal level of analog outputs or switch the output to send AES digital signals.	<ul style="list-style-type: none"> • Mic • Line • -10 • AES 1,2
XLR-R Out	Select the nominal level of analog outputs or switch the output to send AES digital signals.	<ul style="list-style-type: none"> • Mic • Line • -10 • AES 3,4
TA3-X1 Out	Select the nominal level of analog output of the Aux 1 TA3 output. Line is the default.	<ul style="list-style-type: none"> • Mic • Line • -10
TA3-X2 Out	Select the nominal level of analog output of the Aux 2 TA3 output. Line is the default.	<ul style="list-style-type: none"> • Mic • Line • -10
AES Output Routing	Displays the AES output routing matrix where sources can be assigned to AES output channels.	

SUB-MENU	DESCRIPTION	OPTIONS
Playback to Outputs	Select destination for playback signal. By default, this is set to All Outputs.	<ul style="list-style-type: none"> All Outputs Headphones Only
X1, X2 Routing	Displays the X1, X2 Routing screen where sources may be assigned to the X1 and x2 output channels.	
X3, X4 Routing	Displays the X3, X4 Routing screen where sources may be assigned to the X3 and x4 output channels.	
Output Delays	Set independently the delay of L-R, X1, X2, X3 and X4. Default for each is 0.0.	<ul style="list-style-type: none"> 0.0 - 10.0 frames (per output)

Configuring Output Linking

Output linking allows the gain, delay, and track arm status (L, R, X1 and X2 only) of an output pair to be controlled with only one action.

To configure output linking:

1. Press the MENU button.
2. Turn and press the Headphone encoder to select OUTPUTS > Linking.
3. Turn and press the Headphone encoder to select a linking option. Options include: LR, X1X2 (both pairs linked); LR, X1, X2 (only L and R linked); L, R, X1X2 (only Aux 1 and 2 linked); and L, R, X1, X2 (none linked)

Setting Output Type and Nominal Level

By default, left and right XLR balanced outputs are set to analog Line (+4 dBu nominal) level. However, each output—both left and right XLRs and both TA3 outputs for X1 and X2—may be set to Mic, Line, and -10 (analog). Additionally, left XLR and right XLR may be set to AES (digital).

To set output level and type:

1. Press the MENU button.
2. Turn and press the Headphone encoder to select an OUTPUTS submenu, which include: XLR-L Out, XLR-R Out, TA3-X1 Out, and TA3-X2 Out.
3. Turn and press the Headphone encoder to select the output type. Options for each output will vary, but can include: Mic, Line, -10 or AES.

Output Routing

The master L and R tracks are permanently routed to their respective outputs, unless the connections have been set to AES, in which case they use AES output routing.

Accessing AES Output Routing Screen

There is a total of 4 channels of digital output on 2 connections. Each of the XLR-3M outputs can be configured to output AES3 digital signals. For more information, see [Setting Output Type and Nominal Level](#).

Any track can be routed to any AES output in any combination. No sources are assigned to any of the AES outputs by default.

To access the AES Output Routing screen:

1. Press the MENU button.
2. Turn and press the Headphone encoder to select OUTPUTS > AES Output Routing.

Configuring AES Output Sources

The AES Output Routing screen consists of rows that represent each AES output and columns that represent the available source for those outputs.

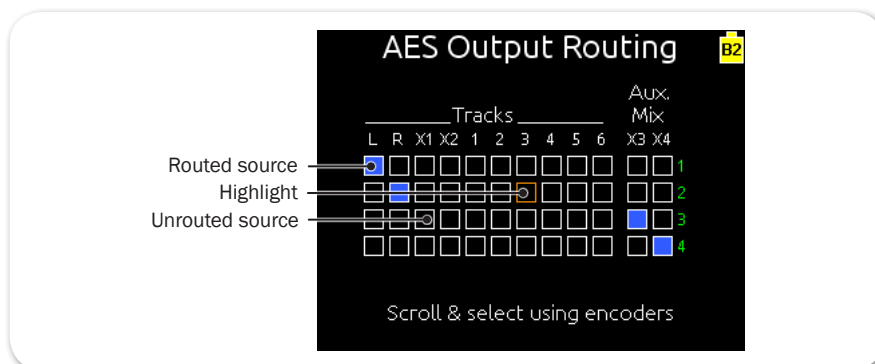

To configure output sources in the AES Output Routing screen:

1. Do one of the following:
 - ▶ Turn the Headphone encoder to move the orange highlight horizontally.
 - ▶ Turn the Select encoder to move the orange highlight vertically.
2. Press the Headphone or Select encoder to change the selected source between Off (black) and On (blue).

① *ISO tracks are routed to AES outputs pre- or post-fade depending on the Input to ISO Routing setting. For more information, see [Configuring Input to ISO Routing](#).*

Accessing Aux (X1 - X4) Routing Screens

Aux 1 and Aux 2 analog signal output is provided on a pair of balanced TA3 connections. Aux 3 and Aux 4 analog signal output is provided on a single, unbalanced, 3.5 mm TRS connection.

ISO tracks or L and R tracks may be routed individually to X1, X2, X3, and X4. ISO tracks may be routed pre- or post-fade. L and R tracks can only be routed post-fade.

Additionally, headphone L and R signal may also be routed to X3 and X4, a feature useful for sending a copy of the monitor signal to a boom operator or other production members. Changing the headphone source will change the copied signal routed to X3 and/or X4.

① *RTN signal cannot be routed to X3 and X4. When headphone signal is routed to X3 or X4, and RTN signal is routed to the headphone preset, RTN signal will be present in the headphone output, but not in X3 or X4.*

Output sources are configured separately in either the X1, X2 Routing or X3, X4 Routing screens.

To access either of the Aux (X1-X4) Routing screens:

1. Press the MENU button.
2. Do one of the following:
 - ▶ Turn and press the Headphone encoder to select OUTPUTS > X1, X2 Routing.

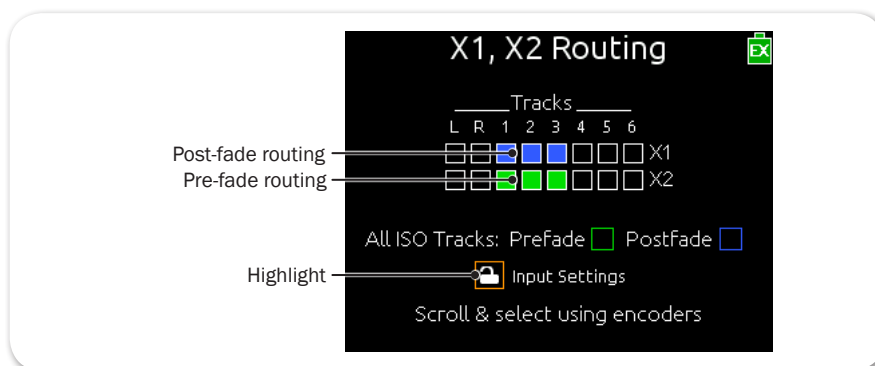

- ▶ Turn and press the Headphone encoder to select OUTPUTS > X3, X4 Routing.

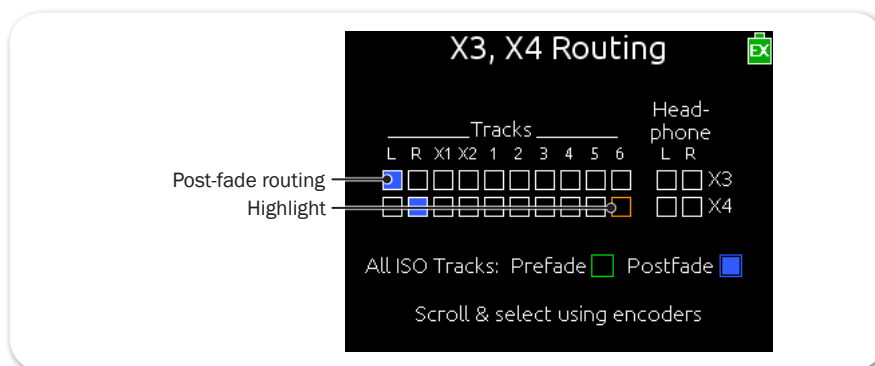

Configuring Aux Output Sources

The Aux (X1-X4) Routing screens consist of boxes that indicate sources available for routing to the chosen output.

The X1, X2 Output Routing screen differs from the X3, X4 Routing screen. For instance, Aux and HP sources are not available, but an additional Input Setting option does appear on the X1,X2 Routing screen:



When Input Setting is set to Locked, changing the X1 and X2 routing from the Input Settings screens is disabled, preventing accidental routing of channels to those outputs using the MIC/TONE switch.

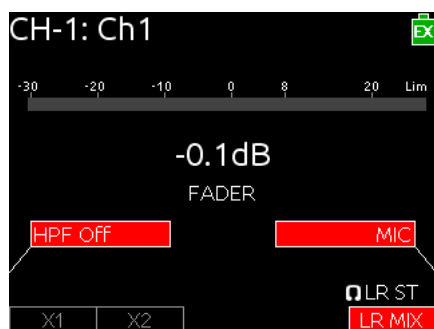

To configure output sources via the Aux (X1-X4) Routing screens:

1. Access either the X1, X2 Routing or X3, X4 Routing screens.
2. Do one of the following:
 - ▶ Turn the Headphone encoder to move the orange highlight horizontally.
 - ▶ Turn the Select encoder to move the orange highlight vertically.
3. Press either encoder to change the selected source between Off (black) and On (blue). Selecting All ISO Tracks, available on either screen, globally applies pre- or post-fade status to all ISO track routings to the Aux outputs.

① *In addition to Off and On, ISO sources have a third option, Pre-Fade (green).*

For X1 and X2, activating an ISO source will turn off any L or R source, and vice versa. For X3 and X4, activating HP sources will turn off all LR, Aux, and ISO sources, and vice versa.

Configuring Playback to Outputs

By default, audio on L and R recorded tracks will be sent to the headphone outputs and both L and R outputs during playback. This can be disabled so that LR analog outputs do not send the playback signal to the L and R outputs.

To configure playback to outputs:

1. Press the MENU button.
2. Turn and press the Headphone encoder to select OUTPUTS > Playback to Outputs.
3. Turn and press the Headphone encoder to select either Headphones Only or All Outputs.

Adjusting Output Delay

The signal of each output can be delayed by up to 10.0 frames. This is useful while interfacing with video equipment when the audio signal is being processed faster than video, creating an audio/video offset.

To adjust output delay:

1. Press the MENU button.
2. Turn and press the Headphone encoder to select OUTPUTS > Output Delays.

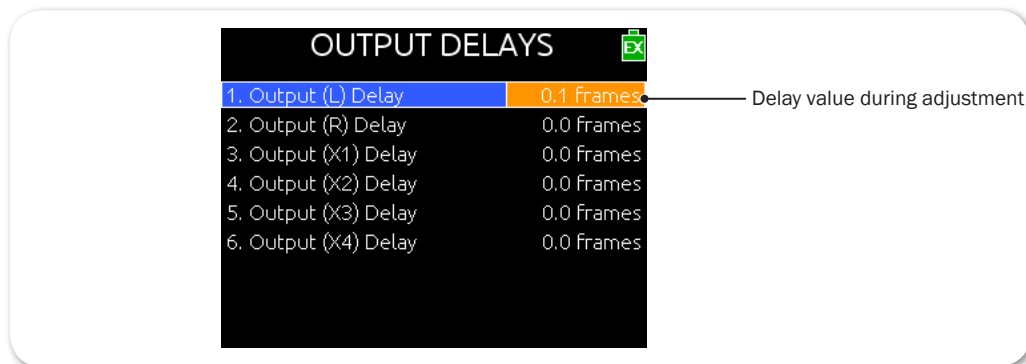

3. Turn and press the Headphone encoder to enter delay adjustment mode. The background of the selected delay becomes orange.
4. Turn the Headphone encoder to adjust the delay value by 0.1 frame increments, from 0.0 (no delay) up to a maximum of 10.0 frames.

Press the Headphone encoder to set the delay value.

Auto-Mute of Aux Outputs

The Auto-Mute feature silences the X1-X4 outputs on the 633 while in stop mode. This maintains privacy when not rolling on set. Auto-Mute is assignable per aux output, and audio returns to the aux outputs during playback and record. Physical outputs are affected by Auto-Mute while auxiliary tracks remain unaffected.

To access the Auto-Mute feature:

1. Navigate Menu>Outputs>X1/X2 Routing or X3/X4 Routing
2. Choose the Auxiliary output you want to Auto-Mute.
3. Scroll to the Auto-Mute box icon.
4. Press the headphone encoder to activate Auto-Mute.

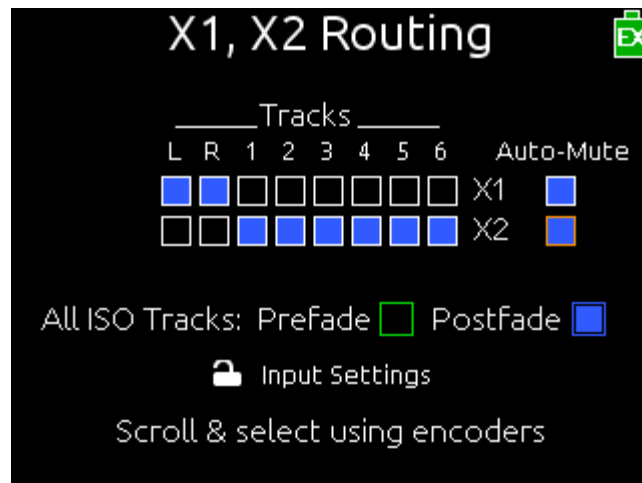

Sending Tone to Outputs

The 633's internal tone oscillator can be used to send a predefined tone or pulse to the mixer's outputs to aid setup of proper gain staging with other equipment, such as cameras. The Left Ident pulsing tone is useful for identifying the left or odd Aux channel of the stereo pair on the receiving device.

To send a continuous tone to outputs:

- ▶ Do one of the following:
 - Slide the MIC/TONE switch to the right for a brief burst of tone.
 - Slide and hold the MIC/TONE switch for one second to turn on a continuous tone. Slide the switch again to turn off the tone.

By default, 1000 Hz tone is sent at 0 dB to all outputs and tracks.

To send an L Ident pulsing tone:

- ▶ Press and hold the SELECT encoder then slide the MIC/TONE switch to the right.

By default, a continuous tone is sent to outputs while the Left Identifier signal pulses the amplitude of tone by -20 dB to the Left channel, X1 and X3 outputs. Repeat the SELECT + TONE combination to turn off the L Ident pulse.

These factory defaults may be customized via System settings. Custom configuration includes: routing to outputs or tracks, setting decibel level and frequency, and changing the functionality of the MIC/TONE switch actions.

For details, see [Setting up Tones and Bells](#).

The 633's digital processing engine delivers 6-channel auto-mixing capability using the most sophisticated algorithms on the market.

Commonly used in multi-mic speech applications, auto-mixing automatically attenuates the level of inputs that are not open and helps maintain consistent background sound levels regardless of the number of open microphones.

On the 633, sound professionals have two powerful Auto Mixers from which to choose: MixAssist™ and Dan Dugan automixing. These are two flavors, which accomplish the same end—improved speech intelligibility, reduction of ambient noise and reverberation, and improved gain-before-feedback.

Topics in this section include:

- ▶ Auto Mixer Screen
 - ▶ Turning the Auto Mixer On or Off
 - ▶ Assigning Inputs to the Auto Mixer
- ▶ Overview of MixAssist
 - ▶ Setting MixAssist Off-Attenuation
 - ▶ LCD Views During MixAssist Automixing
- ▶ Overview of Dugan Automixing
 - ▶ LCD Views During Dugan Automixing



Auto Mixer Screen

While the 633 is capable of auto-mixing all 6 inputs, it may be configured from the Auto Mixer screen to attenuate fewer inputs or none at all.

The 633 also features two auto mixers: Sound Devices own automixing feature called MixAssist and Dan Dugan automixing.

To access the Auto Mixer screen:

1. Press the MENU button.
2. Turn and press the Headphone encoder to select AUTO MIXER. The Auto Mixer screen is displayed.

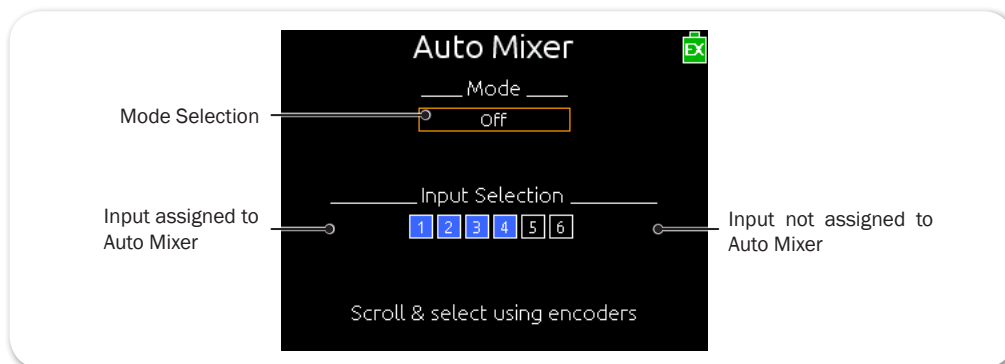

Turning the Auto Mixer On or Off

By default, auto-mixing is turned off, but it may be turned on and any of the 6 inputs can be assigned to the Auto Mixer. See also [Assigning Inputs to the Auto Mixer](#) for more information.

To turn on automatic mixing:

1. Access the Auto Mixer screen.
 2. Press the Headphone encoder to activate Mode selection.
 3. Turn and press encoder again to select a mode to use from one of two options: MixAssist, Dugan AutoMix.
- ① *Auto Mixer, in either mode, is disabled automatically when Main menu option RE-CORDER > Sample Rate is set to a value higher than 48.048 kHz.*

The Auto Mixer screen varies, depending on what mode is chosen.

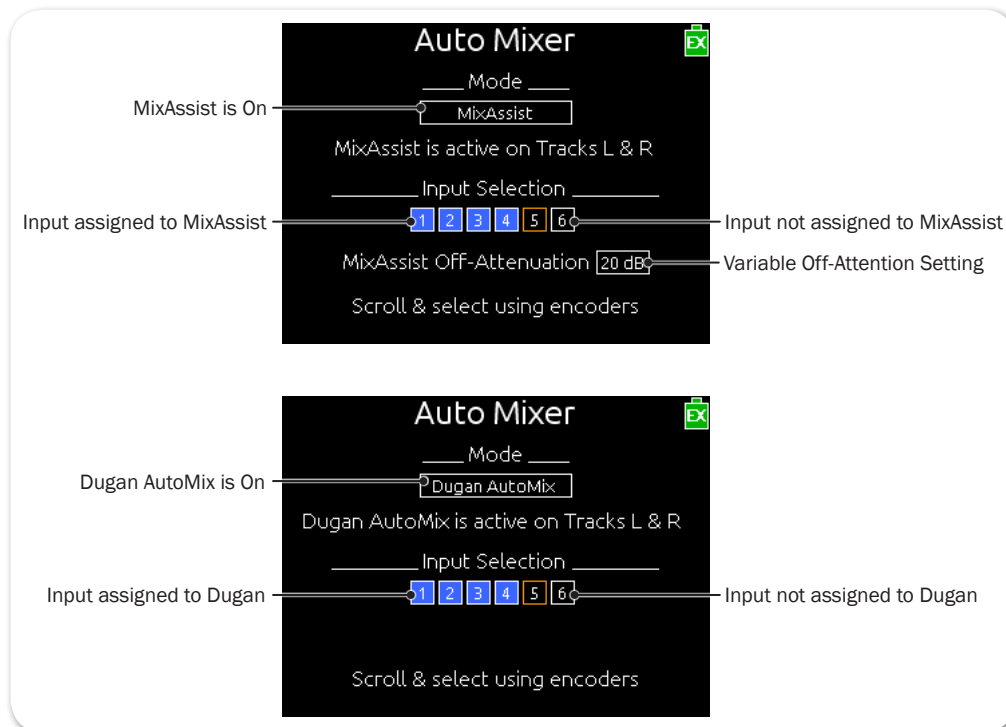

Both Auto Mixer modes are designed for use with multi-mic speech applications and are not intended for musical applications. For more information about each mode, see [Overview of MixAssist](#) and [Overview of Dugan Automixing](#).

To turn off automatic mixing for all inputs:

- From the Auto Mixer screen, select Off in the Mode section.

Assigning Inputs to the Auto Mixer

Inputs that are assigned to an Auto Mixer (MixAssist or Dugan) are referred to as active automixed inputs and will be included in the mix. Inputs not assigned to the Auto Mixer are referred to as inactive automixed inputs and will not be included in the mix.

To assign inputs to MixAssist or Dugan AutoMix:

1. Access the Auto Mixer screen.
2. Turn the Select encoder to move the orange highlight vertically down to the Input Selection section.
3. Turn the Headphone encoder to move the orange highlight horizontally.
4. With the orange highlight positioned on the selected source, press either encoder to change the selected input to either Not Assigned (black) or Assigned (blue).

① *Inputs that are routed post-fader to the L or R bus and do not have Auto Mixer activated will not be auto-mixed but will still be analyzed by MixAssist for the purposes of Last Mic Lock-On, One Mic Per Sound Source, and Number of Open Mics Attenuation.*

Overview of MixAssist

The Sound Devices MixAssist feature auto-mixes post-fade input signals to the left (L) and right (R) buses. Other signals are not affected by MixAssist.

MixAssist does not limit the number of open microphones and will allow several microphones to be open simultaneously if there are several talkers. MixAssist also intelligently attenuates redundant mics that are picking up the same sound source, which significantly helps to reduce comb filtering and phasing artifacts.

Inputs that are automixed will be open (unattenuated) when a person talks into the input's microphone and closed (attenuated) when the person stops talking.

Microphone channels open with ultra-sensitive responsiveness to voice levels to ensure that no syllables are lost, and then will "gate off" smoothly over 500mS. This gating action is smooth and imperceptible when switching between microphones. MixAssist is more sophisticated than a simple gate, and uses four different principles to automix input signals: noise adaptive threshold, one mic per sound source, number of open mic attenuation, and last mic lock-on.

Noise Adaptive Threshold

When an input's post-fade level surpasses the MixAssist threshold, it will be opened. Unlike a simple limiter or gate, this threshold is dynamic: MixAssist continuously analyzes all inputs assigned to it to determine an average noise floor level and uses that level as the threshold. This prevents common background noise (fans, crowd murmur, etc.) from causing the input to open, while allowing normal sounds to open the mic.

One Mic Per Sound Source

Often a sound source, such as someone speaking, is captured by more than one microphone. MixAssist actively compares signals from all inputs and when it senses the same audio on multiple inputs, it will only open the input in which that specific program audio arrived first and is loudest.

- ① *This does not prevent another input from opening when unique program audio is sensed at that input.*

Number of Open Microphone Attenuation

As the number of open inputs increases, the level of each input as it is routed to the track will decrease by 3 dB per doubling of open mics. This ensures that the overall level of the track is consistent regardless of the amount of open inputs routed to it.

Last Mic Lock-On

When talking stops, the last input to be active will remain open. This maintains a consistent level of natural sound and avoids a dramatic transition to silence on the track, even when no inputs are in use.

Setting MixAssist Off-Attenuation

The 633 also lets the user define the amount of off-attenuation that MixAssist uses during the auto-mixing process.

To set the amount of off-attenuation for MixAssist:

1. From the Auto Mixer screen, with MixAssist set as the Mode, use the Select encoder to move the orange highlight vertically down to the MixAssist Off-Attenuation field.
2. Press the Headphone encoder to select the field; its background will appear orange.

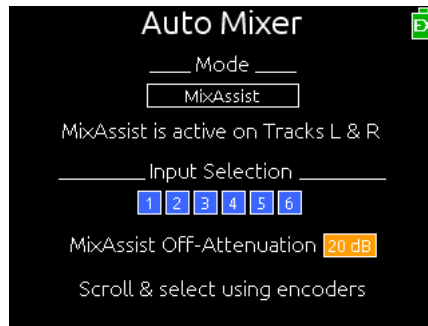

3. Turn the Headphone encoder to change the setting. Range is from 6 dB to 40 dB in 1 dB increments.

LCD Views During MixAssist Automixing

A circle icon is displayed next to the meter for each active automixed input. When the input is open, the circle will be green. As the input closes, the circle will fade to black.

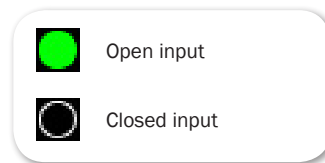

The Meters view displays these circle icons to the right of (horizontal meters) the active automixed inputs.

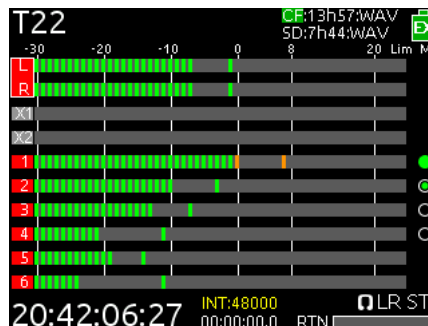

The Input Settings screen will display the circle icon to the right of the meter.

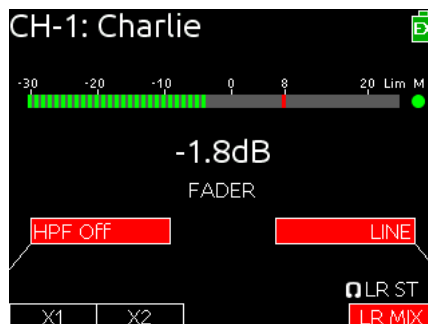

Overview of Dugan Automixing

In collaboration with Dan Dugan Sound Design, Inc., Sound Devices offers another powerful automixing option as part of the 688's Auto Mixer. The Dugan Speech System™ uses Dugan's own patented automixing algorithm that has been an industry standard for many decades.

Dugan's system operates on a very elegant principle: each individual input channel is attenuated by an amount (in dB) equal to the difference (in dB) between that channel's level and the sum of all channel levels. The gain of all channels is adjusted immediately and continuously based on what each channel is receiving. The neat aspect of this mathematical construct is that the total gain through the system never changes—always stays at 0dB. The core concept of this mixer is totally automatic, so there are no thresholds or other adjustments to set.

With Dugan automixing, multi-mic speech applications are mixed with smooth automatic cross-fades for clear, optimized audio recordings.

LCD Views During Dugan Automixing

A circle icon is displayed next to the meter for each active automixed input. The amount of purple filling the circles indicates the level of automix attenuation. If the input is panned left or right, a purple half circles appears accordingly.

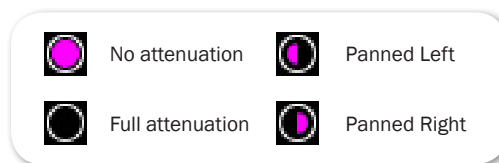

The Meters view displays these circle icons to the right of (horizontal meters) the active mixed inputs.

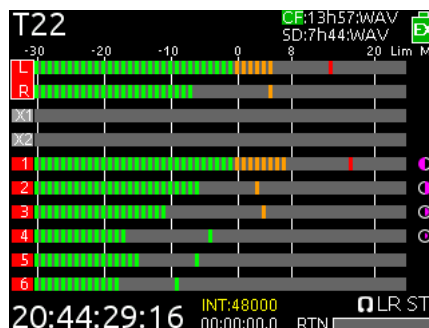

The Input Settings screen will display the circle icon to the right of the meter.

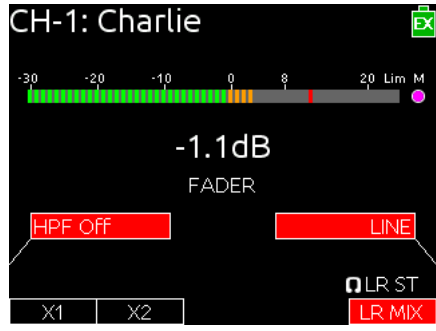

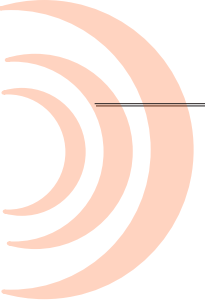

Limiters prevent clipping by attenuating signals that exceed a set threshold. The amount of attenuation is defined by the ratio of the limiter and expressed as two numbers.

The time it takes for limiting to begin once signal has exceeded the threshold is referred to as the attack time, and the time it takes for limiting to cease once signal has fallen back below the threshold is referred to as release time.

Topics in this section include:

- ▶ Overview
- ▶ Enabling the Limiters
- ▶ Adjusting the Threshold
- ▶ Linking Limiters

Overview

Sound Devices recommends using limiters at all times. Without input limiters, high signal conditions can overload a channel and cause distortion. In normal operation, with a properly set gain structure, the threshold of the input limiter is rarely reached. The default threshold of all limiters on the 633 is 16dBu.

All 633 limiters use a 20:1 compression ratio. This means that any signal that exceeds the threshold by 20 dB will exit the limiting stage at only 1 dB above the threshold. The 633 limiters have a 1 ms attack time and a 500 ms release time.

The input limiter is actively limiting when the respective input's Input Activity LED illuminates yellow. Limiting activity will also be displayed as a yellow square on the right side of the input's meter on the Main screen. If the limiting activity is regularly indicated, reduce the amount of gain applied to the channel by turning down the Trim control.

Enabling the Limiters

When enabled, the limiters are globally activated at either a Hard Knee or Soft Knee setting. The knee of the limiter determines how the limiter operates in relation to the set threshold. With hard knee, when the signal reaches the threshold, the mixer immediately attenuates only those peaks above the threshold, compressing at whatever ratio is set. With soft knee, attenuation begins slightly before the threshold—at about 6 dB—for a more gradual, tape-like sound, making the compression much more difficult to detect.

To enable or disable limiters:

1. Press the MENU button.
2. Turn and press the Headphone encoder to select LIMITERS > Limiter Enable.
3. Turn and press the Headphone encoder to activate or deactivate the limiter. Options include: Off, Hard Knee, and Soft Knee.

Adjusting the Threshold

The default threshold of all limiters is 16 dBu; however, that may be adjusted from 4 dBu to 18 dBu in 1 dBu increments.

To adjust the threshold:

1. Press the MENU button.
2. Turn and press the Headphone encoder to select LIMITERS.
3. Define the threshold parameters based on the following table:

PARAMETER	DESCRIPTION	OPTIONS
Input 1-6 Post-Fade Threshold	Sets the level at which input limiters will begin attenuating on inputs 1-6.	• +4 dBu - +18 dBu (1 dBu increments)
L, R Threshold	Sets the limiter threshold for the Master Bus.	• +4 dBu - +18 dBu (1 dBu increments)
X1, X2 Threshold	Sets the limiter threshold for the Aux Bus.	• +4 dBu - +18 dBu (1 dBu increments)

Linking Limiters

Limiters for L, R and X1, X2 channel pairs can be linked on the 633. Anytime two limiters are linked, both channels will be limited when signal reaches the threshold in any channel of the pair.

① *Linking inputs as a stereo pair also links those inputs' limiters.*

To link limiters:

1. Press the MENU button.
2. Do either one or both of the following:
 - ▶ Turn and press the Headphone encoder to select LIMITERS > L, R Linking.
 - ▶ Turn and press the Headphone encoder to select LIMITERS > X1, X2 Linking.
3. Turn and press the Headphone encoder to set linking. Options include: On or Off.

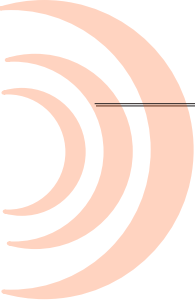

The 633 offers 10-track, polyphonic or monophonic broadcast WAV file recording—or two tracks of compressed MP3 audio—to Secure Digital (SD) and CompactFlash® (CF) cards. These memory cards are an easy-to-source, reliable, and affordable file storage option that also may be quickly delivered to post immediately after recording stops.

All common sampling rates are supported, including up to six tracks at 192 kHz.

The memory cards can be set independently, recording either identical material for real-time backup, or combinations of WAV Poly, WAV Mono and MP3 files.

Topics in this section include:

- ▶ Using Media
- ▶ Using the Transport Control
- ▶ Arming or Disarming Recording Tracks
- ▶ Accessing Recorder Settings
- ▶ Setting File Type and Media Track Assignment
- ▶ Changing the MP3 Bit Rate
- ▶ Setting the Sample Rate
 - ▶ F Sample Modes
- ▶ Setting the Bit Depth
- ▶ Setting the Pre-roll
- ▶ Using the Slate Microphone
- ▶ Playing Back Active Takes
- ▶ Viewing Approved Media List via Smart Phone

Using Media

Before recording anything, install and format the media storage memory cards you intend to use in the 633. The slots for memory cards are located on the right panel behind the Media Door, which is held closed magnetically.

To insert media:

1. Firmly pull open the Media Door.
2. Insert your choice of media memory card into the slots provided.

When inserting the SD card, ensure the bottom of the card (the side with metal contacts visible) is facing the rear of the unit. When inserting a CF card, ensure the top of the card (the side with the branding label) is facing the rear of the unit.

- ① *Sound Devices Quality Assurance engineers have done extensive testing to ensure media approved for use with the 633 works reliably and provides the best performance in a variety of extreme conditions. When choosing your media, please refer to the [Approved Media List](http://www.SoundDevices.com/ApprovedMedia) available on the Sound Devices website at: www.SoundDevices.com/ApprovedMedia. For more information, see also [Viewing Approved Media List via Smart Phone](#).*

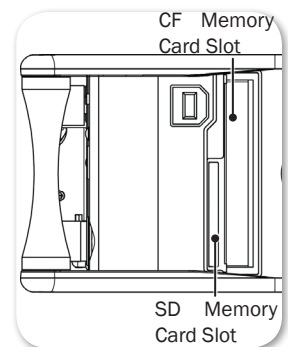
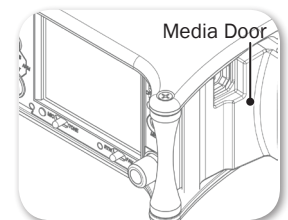

The memory card must be formatted before recording.

Reformatting a card will erase all data on the card.

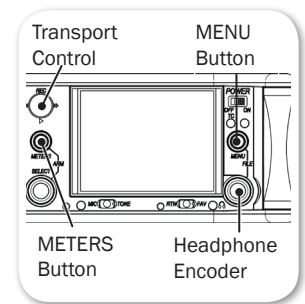

To (re)format an SD or CF card:

1. Press the MENU button.
2. Turn and press the Headphone encoder to select File Storage.
3. Do either of the following:
 - Select Erase/Format CF to reformat a Compact Flash card.
 - Select Erase/Format SD to reformat a Secure Digital card.
4. Press the Headphone encoder to begin the formatting process.
5. Read any warning message(s) and press the Headphone encoder to continue.
6. Press the METERS button to return to the Main screen.

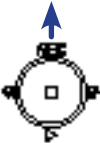

Using the Transport Control

The 5-position Transport control is used to perform all recording and playback functions.

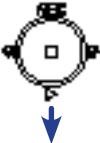
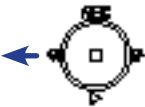
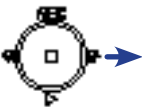
FUNCTION	DIRECTION	ACTION
Record		Push up the Transport control. Begins recording a new file.
Pause / Stop		Press in the Transport control. While recording, press once to stop recording. While in playback, press once to pause, and press again to stop. While in standby, press and hold to display next take name.
Play		Push down the Transport control. Begins playback of the last file recorded or file currently loaded.
Rewind / Load previous take		Push the Transport control left. While in standby, push left to load the previous take. While in playback, push and hold left to rewind.
Fast forward / Load next take		Push the Transport control right. While in standby, push right to load the next take. While in playback, push and hold right to fast forward.

To make a recording:

1. Push up the Transport control. Recording will begin.

While recording, both the take name background color (top of Main screen) and timecode counter (bottom left of Main screen) will become red, and the absolute time counter (bottom of Main screen) will run. Additionally, the time remaining value of CF and SD will appear yellow while the media is being accessed.

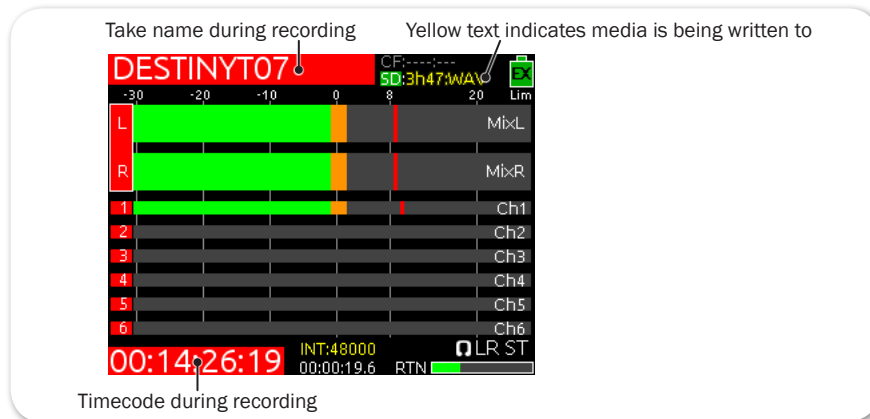

2. Press in the Transport control to stop recording.

① *Some transport controls, such as start/stop record and arming tracks may be done from the Wingman app. For more details, see [Wingman Integration: 6-Series](#).*

Arming or Disarming Recording Tracks

The 633 features 10 recording tracks. Each of the six inputs is permanently routed to its associated ISO track. Buses L, R, X1, and X2 can also be armed for recording.

ISOs can be sent to both pre- and post- fade. X1 and X2 can record any combination of channels pre- or post-fade.

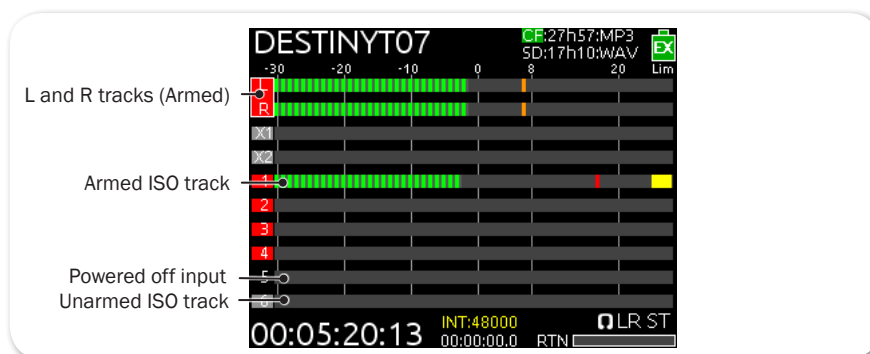

To arm or disarm a track for recording:

1. Press the METERS button repeatedly until the chosen track is visible on the Main screen.
2. Turn the SELECT encoder to move the white highlight to the chosen track.

- METERS + SELECT: Press the METERS button and SELECT encoder together. The background color changes to indicate the track's armed status. Red = armed, Grey = unarmed, and Black = input powered off.

Accessing Recorder Settings

The Main menu has a sub-menu of settings related to recording. These may be used to customize the configuration of the 633's Record settings.

To access the Recorder sub-menu:

- Press the MENU button
- Turn and press the Headphone encoder to select RECORDER.

SUB-MENU	DESCRIPTION	OPTIONS
Record to CF	Sets the type of file and which tracks to record to the CF card. The default is Wav Poly.	<ul style="list-style-type: none"> Off Wav Poly Wav Poly (ISOs Only) Wav Poly (LR Only) Wav Poly (X1X2 only) MP3 (LR) MP3 (X1X2) Wav Mono Wav Mono (ISOs only)
Record to SD	Sets the type of file and which tracks to record to the SD card. The default is Wav Poly.	<ul style="list-style-type: none"> Off Wav Poly Wav Poly (ISOs Only) Wav Poly (LR Only) Wav Poly (X1X2 only) MP3 (LR) MP3 (X1X2) Wav Mono Wav Mono (ISOs only)
<p><i>ⓘ When a CL-12 is in use and both media are set to Wav Mono, the following message will appear when the REC button is pressed to begin recording.</i></p> <p><i>"When CL-12 is in use, it is highly recommended to record monophonic files to only one card. Set one card to polyphonic and the other to monophonic."</i></p>		
MP3 Bit Rate	The bit rate of recorded MP3 files. The default is 320kbs.	<ul style="list-style-type: none"> 320kbs 192kbs 128kbs
Sample Rate	The internal sample rate and sample rate of recorded WAV files. The default is 48k.	<ul style="list-style-type: none"> 44.1k 47.952k 47.952kF 48k 48.048k 48.048kF 88.2k 96k 192k
Bit Depth	The bit depth of recorded WAV files. The default is 24.	<ul style="list-style-type: none"> 24 16

SUB-MENU	DESCRIPTION	OPTIONS
Pre-roll Time	<p>Adjust the amount of record time to be appended before each recording. Maximum value is 3 seconds when recording WAV Mono files to any media.</p> <p>Higher sample rates also limit pre-roll. Rates of 88.2 and 96k should be 3 seconds, and 192 kHz is 1 second.</p> <p>The default is 0 seconds.</p>	<ul style="list-style-type: none"> • 0 - 6 seconds (1s increment)

Setting File Type and Media Track Assignment

The 633 supports simultaneous recording to CF and SD media. By default, all armed tracks are recorded to both cards as a polyphonic WAV file. It is possible to record only the armed ISO tracks, only the armed L and R tracks, or only the armed X1 and X2 tracks to either media.

To set file type and track routing:

1. Press the MENU button.
2. Turn and press the Headphone encoder to select either of the following:
 - RECORDER > Record to CF
 - RECORDER > Record to SD
3. Turn and press the Headphone encoder to choose a file type and track assignment for the chosen media. For more information on available options, see [Accessing Recorder Settings](#).

WAV (Broadcast WAV)

The 633 writes AES-31 broadcast WAV formatted files. The audio files created by the 633 include additional metadata in the file's header, Broadcast Audio Extension (BEXT) and iXML data chunks. Software that does not recognize these additional broadcast WAV data chunks will ignore them. For more information, see [Metadata Overview](#).

MP3

MPEG-1 Layer III is a lossy compression algorithm, often used for music and transcription recording purposes. The 633 records two-channel MP3 audio files with data rates of 128, 192, and 320 kbs. For more information, see [Changing the MP3 Bit Rate](#).

- ① *MP3 recording is only possible when RECORDER > Sample Rate is set to 44.1k or 48k.*

Changing the MP3 Bit Rate

The 633 records MP3 files at a default bit rate of 320kbs, but that bit rate may be changed. A high bit rate MP3 file preserves more audio information with an increased file size. A low bit rate MP3 file preserves less audio information with a decreased file size.

To change the MP3 bit rate:

1. Press the MENU button.
2. Turn and press the Headphone encoder to select RECORDER > MP3 Bit Rate.
3. Turn and press the Headphone encoder to select a bit rate. Options include: 128, 192, and 320 kbs.

Setting the Sample Rate

The 633 records WAV files at 48 kHz sample rate by default.

To set sample rate:

1. Press the MENU button.
2. Turn and press the Headphone encoder to select RECORDER > Sample Rate.
3. Turn and press the Headphone encoder to select a sample rate. Options include: 44.1k, 47.952k, 47.952kF, 48k, 48.048k, 48.048kF, 88.2k, 96k, and 192k.

The sample rate value is stored in file metadata. Those options with "F" are F mode rates. The F stands for "faux" or "Fostex".

Certain restrictions apply when using sample rates at or greater than 88.2 kHz:

	88.2 - 96 kHz	192 kHz
Maximum record tracks	8	6
WAV mono recording	Warning Message displayed: Sample rate limit for Wav Mono recording exceeded. Reduce sample rate or set to Wav Poly.	
Maximum pre-roll time	3 seconds	1
High-pass filters	Unchanged	Off or 50 Hz
X3/X4 outputs	Available	Available
AES outputs	Available	Disabled
Limiters	Available	Disabled
Input delay	Available	Disabled
Output delay	Available	Disabled

F Sample Modes

The 48.048kF mode is used in specific work flows with Avid®, Final Cut Pro®, and other post-production environments that do not recognize audio files written at 48.048 kHz. In this mode files are recorded at a 48.048 kHz sampling rate but are stamped at 48 kHz. When played, they will play back 0.1% slower than real time.

One use for the 48.048kF mode is to force a 0.1% speed reduction (pull down) of audio to match MOS-telecined film (24 fps-to-NTSC) in non-linear edit systems, such as Avid or Final Cut Pro. Since the file is stamped as a 48 kHz file, the edit system will play it back at 48 kHz and not at 48.048 kHz. This “audio pull down” will match the transferred picture without the need for an intermediate step through other software to create the pull down.

When using 48.048kF sample rate, set main menu option TIMECODE > Frame Rate to 30ND or 24. When set to 30ND, files will be stamped with a frame rate of 29.97. When set to 24, files will be stamped with a frame rate of 23.97ND.

Both 47.952 and 47.952kF settings use a record sampling rate of 47.952 kHz, 0.1% lower than 48 kHz. The 47.952kF mode, however, identifies the file as being recorded at 48 kHz.

When using 47.952kF sample rate, set main menu option TIMECODE > Frame Rate to 23.97ND or 29.97ND. When set to 23.97ND, files will be stamped with a frame rate of 24. When set to 29.97ND, files will be stamped with a frame rate of 30ND.

ⓘ MP3 recording is not allowed in “F mode”.

Setting the Bit Depth

The 633 records 24 bit WAV files by default. Bit depth defines the digital word length used to represent a given sample and correlates to the maximum dynamic range that is represented by the digital signal. Larger bit depths accommodate a wide dynamic range.

To set bit depth:

1. Press the MENU button.
2. Turn and press the Headphone encoder to select RECORDER > Bit Depth.
3. Turn and press the Headphone encoder to select 24 or 16.

ⓘ The bit depth value is stored in file metadata.

Setting the Pre-roll

Pre-roll buffering is available on the 633 to help prevent missing record cues or up-cutting takes. By default, the pre-roll time is 0 seconds (off). When active, pre-roll begins recording at a set number of seconds preceding the record button being pressed.

To set pre-roll time:

1. Press the MENU button.
2. Turn and press the Headphone encoder to select RECORDER > Pre-roll Time.
3. Turn and press the Headphone encoder to select a value (0 s to 6 s).

① *While a pre-roll time may be set regardless of the timecode mode, pre-roll is ignored whenever timecode mode is set to Record Run. Additionally, when the mixer's timecode mode is set to either External Timecode Auto Record, or External Timecode Continuous Auto Record, pre-roll is only applied within the Hold Off period and never before receiving rolling timecode value from the master external timecode source. This prevents possible overlapping timecode numbers between adjacent files. For more information, see [Setting the Timecode Mode and Setting Timecode Hold Off](#).*

① *Maximum pre-roll time is 3 seconds when RECORDER > Sample Rate is set to 88.2k or 96k.*

Maximum pre-roll time is 1 second when RECORDER > Sample Rate is set to 192k.

Using the Slate Microphone

The 633's built-in slate and external microphone is used to notate scenes from the mixer location. Its audio performance is not suitable for critical recording applications. It should be used for documenting scenes and for communication purposes only.

To use the slate microphone:

1. Slide the MIC/TONE switch left to activate the slate mic. The Slate/Tone LED illuminates green to indicate the slate mic is active.
2. Slide the MIC/TONE switch left again to deactivate the slate mic.

① *By default, the slate mic is routed to all tracks and outputs. The gain of the slate mic can be adjusted. For details, see [Setting Slate Mic Gain](#).*

Playing Back Active Takes

Playback may be initiated at any time except when the 633 is recording. Unless playback is initiated from the Take List or File List, the active take will be played from the current playback card. The active take is whichever take was recorded or played most recently. The active take is displayed at the top of the Main screen.



To play back the active take:

- ▶ Push the Transport control down in any view beside the File List or Take List.
- ▶ To play back a specific file from the Take List or File List, push the Transport control down while a file is highlighted in one of those views. For details, see [Take List Overview](#) and [Accessing the File List](#).

To toggle playback to a different media card:

- ▶ HP + Play: Press and hold the Headphone encoder, then push the Transport control downward (Play).

Viewing Approved Media List via Smart Phone

The 633 provides QR codes on screen for smart phone access to product-related documentation, including the Approved Media List, available online.

- ① *Accessing documentation via a QR code requires the installation on your smart phone of a code reader application—many of which are available as free downloads from App stores.*

To access the Approved Media List via QR code:

1. Press the MENU button.
2. Turn and press the Headphone encoder to select RECORDER > Approved Media List.
3. Using your phone's code reader application, scan the QR code to access the Approved Media List, which is a web page on the Sound Devices website.

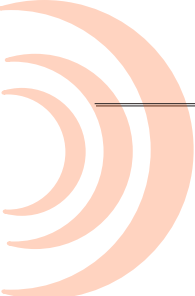

The 633 is equipped with one stereo return (RTN) which allows the Sound Mixer to hear camera audio directly from the 633 interface to ensure quality audio is being sent to camera.

The 633 can also utilize its built-in slate mic for an “all call” (Slate) to any of its outputs or record tracks.

Topics in this section include:

- ▶ Disabling the Slate Microphone
- ▶ Setting Slate Mic Gain
- ▶ Routing the Slate Mic
- ▶ Using the Slate for Notation
- ▶ RTN Monitoring

Disabling the Slate Microphone

The slate microphone can be used to audibly identify a scene or slate at the start of recording or communicate one-way with other members of the production crew. The 633 incorporates a built-in slate mic, located near the left edge of the mixer’s front panel.

The slate mic’s audio performance is not suitable for critical recording applications; it should be used for documenting scenes and for communication purposes only.

The slate microphone is enabled, by default, but may be turned off.

To disable the slate microphone:

1. Press the MENU button.
2. Turn and press the Headphone encoder to select SYSTEM > Slate Mic.
3. Turn and press the Headphone encoder to select Off. This disables the left slide action of the MIC/TONE switch.

① *Repeat the procedure, selecting On, to re-enable the built-in slate mic.*

Setting Slate Mic Gain

The gain of the slate microphone is 36 dB by default. If this gain is too high, it can be adjusted:

To adjust slate microphone gain:

1. Press the MENU button.
 2. Turn and press the Headphone encoder to select SYSTEM > Slate Mic Gain.
 3. Turn the Headphone encoder to adjust slate mic gain (0 dB - 36 dB).
- ① *For quick adjustment of slate microphone gain, slide the MIC/TONE switch to the left and hold while turning the Headphone encoder.*

Routing the Slate Mic

By default, the slate microphone is routed to all outputs and tracks. This routing may be customized.

To route the slate microphone:

1. Press the MENU button.
2. Turn and press the Headphone encoder to select SYSTEM > Slate & Tone Routing. The Slate and Tone Routing screen is displayed.

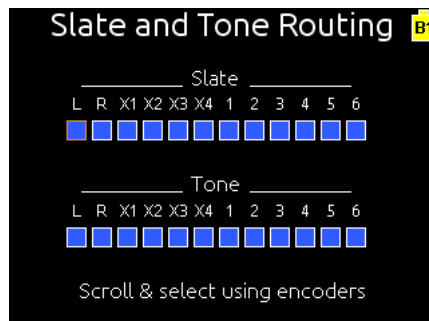

3. Do one of the following:
 - ▶ Turn the Headphone encoder to move the orange highlight horizontally.
 - ▶ Turn the Select encoder to move the orange highlight vertically.
4. Press either encoder to change the selected source between Off (black) and On (blue).

Using the Slate for Notation

To activate the slate function momentarily:

1. Slide and hold the MIC/TONE switch left. The slate mic activates, the Slate/Tone LED illuminates green, and the headphone monitor source changes to SLATE when slate is active.
2. Release the MIC/TONE switch. The slate mic deactivates, the Slate/Tone LED turns off, and the headphone monitor reverts to its previous source.

To lock the slate function on:

1. Slide the MIC/TONE switch left. The slate mic activates, the Slate/Tone LED illuminates green, and the headphone monitor source changes to SLATE.
2. Slide the MIC/TONE switch left again. The slate mic deactivates, the Slate/Tone LED turns off, and the headphone monitor reverts to its previous source.

RTN Monitoring

Return audio, fed to the 633 via the RTN input on the mixer's right panel, can be quickly monitored on the headphone output with a toggle of the RTN/FAV switch.

When monitoring return audio, RTN metering is displayed as either part of the meter view (as shown in far right image) or as a smaller RTN meter located in the bottom right corner of the screen (as shown in the other two predefined meter views). When displayed as part of the meter view, the smaller RTN meter is replaced with the date and time.

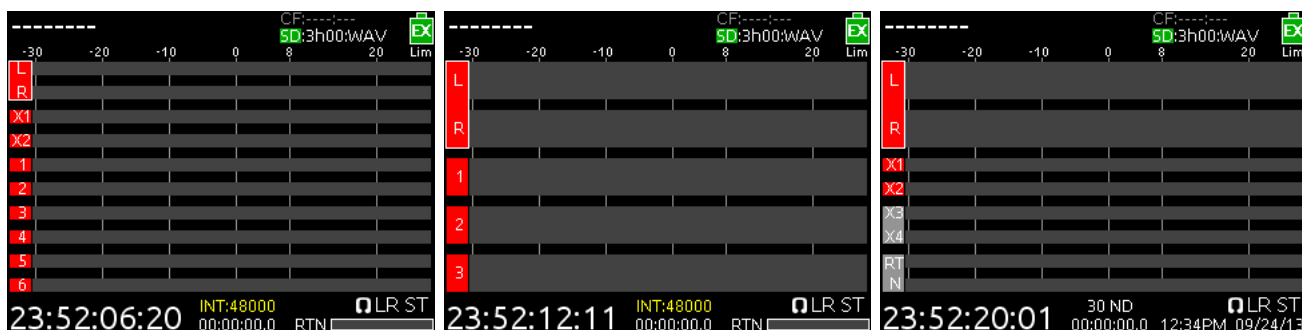

To adjust the RTN level:

1. Press the METERS button to toggle to a meter view that displays RTN metering.
2. Turn and press Select encoder to choose the RTN meter. The RTN meter label will change to orange to indicate Level Adjustment mode.

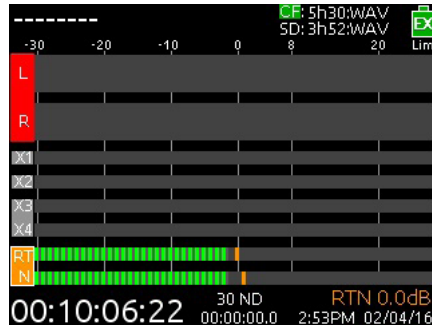

3. Turn the Select encoder to adjust the RTN level, which can be adjusted in 1 dB increments from 0 dB down to -30 dB. During adjustment, the value is displayed in the lower right corner of the screen.
4. Press the Select encoder again to exit Level Adjustment mode. Otherwise, Level Adjustment mode will end if the encoder is not turned for 2 seconds.

The 633 features a fully-integrated Ambient™ timecode generator and reader that supports all common rates and modes. The 633 holds accurate timecode for up to two hours after shutdown, using its own internal, Lithium-Ion timecode battery. This timecode battery is charged whenever the 633 is powered on.

① *After two hours without power, the 633 reverts to a slightly less-precise time-of-day crystal to maintain the date and time on the device.*

Topics in this section include:

- ▶ Timecode
 - ▶ Setting the Timecode Mode
 - ▶ Setting the Frame Rate
 - ▶ Setting Timecode Hold Off
 - ▶ Jamming the Timecode
 - ▶ Setting the Timecode Generator
 - ▶ Setting User Bits
 - ▶ Setting Display Mode

Timecode

File-based recorders place a timecode and frame rate stamp in the BEXT and iXML chunks of an AES31 Broadcast WAV file. During playback, the mixer generates SMPTE timecode from this number and extrapolates it based on the timecode frame rate. All files generated by the mixer have timecode numbers that begin on the 0 frame (or 02 in DF modes) and end on the 0 frame such that a file's duration is always an integer number of seconds long. If necessary, pre-roll and post-roll is dynamically applied to accomplish this, simplifying synchronization in post-production. The timecode value and frame rate of the 633 are displayed on the Main screen.

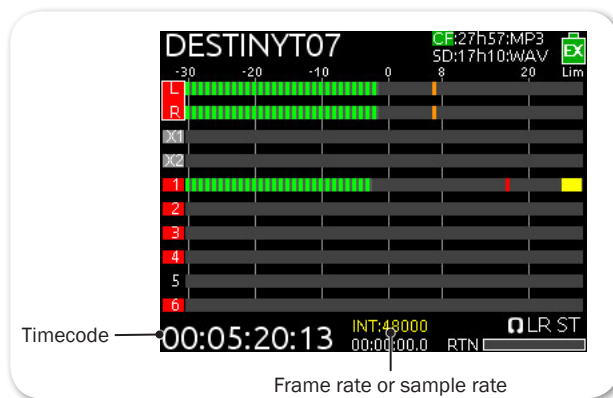

① *If sample rate is displayed—as shown—instead of the frame rate, toggle the view to frame rate by holding METERS down and slide the RTN/FAV switch to the left.*

Setting the Timecode Mode

The Timecode mode determines if the mixer generates or reads timecode from an external source, and when timecode runs and stops.

To set the Timecode mode:

1. Press the MENU button.
2. Turn and press the Headphone encoder to select TIMECODE > Timecode Mode.
3. Select a mode. Options include:

OPTIONS	MODE TYPE	DESCRIPTION
Off	N/A	Turns timecode mode off.
Rec Run	Generator	Timecode runs while recording and is stationary when not recording. In this mode, timecode defaults to the last stationary value at power-up. When switching to Record Run from another mode, the internal generator will stop at the last timecode value.
Free Run	Generator	Timecode runs continuously. Timecode continues counting for up to two hours after power-down.
Free Run Auto Mute	Generator	Timecode runs continuously; however, timecode output is muted during standby. This is useful for triggering external devices when in free run timecode workflows.
Free Run Jam Once	Generator	Allows the mixer to automatically jam to an external valid timecode source when first connected. Once jammed, the mixer will retain the timecode count even when disconnected from external source and for up to two hours after the mixer is powered down.
24h Run	Generator	Timecode runs continuously with its value based on the mixer's time and date settings. This is useful for workflows requiring timecode be referenced to the Actual Time clock.
24h Run Auto Mute	Generator	Timecode runs continuously with its value based on mixer's time and date settings; however, timecode output is muted during standby.
Ext-TC	Reader	Timecode is derived from external timecode sources.
Ext-TC Auto-Rec	Reader	Timecode is based on external timecode sources, and allows recording on the mixer to be triggered via external timecode starting and stopping.
Ext-TC/Cont	Reader/ Generator	Timecode is based on external timecode sources. If timecode is disconnected, the mixer continues counting from the same value, using its internal timecode generator. This is useful when working with wireless timecode sources, allowing the mixer to free-wheel through wireless dropouts.

OPTIONS	MODE TYPE	DESCRIPTION
Ext-TC Auto-Rec/Cont	Reader/Generator	Timecode is based on external timecode sources, and allows recording on the mixer to be triggered via external timecode starting and stopping. Also, if timecode is disconnected, the mixer continues counting from the same value, using its internal timecode generator. This is useful when working with wireless timecode sources, allowing the mixer to free-wheel through wireless dropouts. In the event of a dropout, the mixer will stop recording when it receives a stationary value.

Setting the Frame Rate

By default, the 633's frame rate for the timecode generator is set to 30nd.

① *The frame rate value is stored in the Frame Rate field of metadata.*

When using an external timecode mode, ensure the mixer's frame rate is equal to (or cross-jam compatible to) the external frame rate.

To set frame rate for the timecode generator:

1. Press the MENU button.
2. Turn and press the Headphone encoder to select TIMECODE > Frame Rate. Options include: 23.98, 24, 25, 29.97nd, 29.97df, 30nd and 30df.

Setting Timecode Hold Off

Some devices that send Rec-Run timecode will have a tendency to occasionally send short bursts of running or invalid timecode. When using these devices as an external timecode to trigger recording, this behavior can result in unintentional recordings or invalid timecode stamps on the mixer. To prevent this, the 633 features a Timecode Hold Off function.

This feature only applies when in Ext-TC Auto-Rec and Ext-TC Auto-Rec/Cont timecode modes.

When using these external timecode auto-record modes, the 633 will delay the start of recording for a specified "hold" time. Running timecode that lasts for less than the Hold Off value will not trigger a recording on the 633.

To set up Timecode Hold Off:

1. Press the MENU button.
2. Turn and press the Headphone encoder to select TIMECODE > Hold Off.
3. Specify the hold time in 0.1 second intervals. Options include: 0.0 s - 8.0 s.

① *If a pre-roll time is set, it will be applied. Pre-roll will only capture audio from the initial detection of a timecode signal. If no pre-roll is selected, the file will begin after the Hold Off period expires. It is best practice to set pre-roll to a value greater*

than the specified Hold Off value. This ensures that audio is captured from the moment a timecode signal is detected and that unintentional files triggered by short bursts of timecode are not generated.

Jamming the Timecode

The Jam Received TC screen (better known as the Timecode Jam menu) displays detailed information about the mixer's internal SMPTE timecode generator and external SMPTE timecode received via the mixer's timecode input. It also shows any difference between the two and features a button allowing you to jam the timecode if necessary.

If the mixer's time and date are reset during the production day, or if the Timecode mode is changed from 24h Run to another mode and back, the timecode value will change. To ensure proper synchronization, you must re-jam all timecode devices.

To access the Timecode Jam menu, do one of the following:

- ▶ Press METERS + MIC.
- ▶ Press MENU, and then use the Headphone encoder to select TIMECODE > Jam Menu.

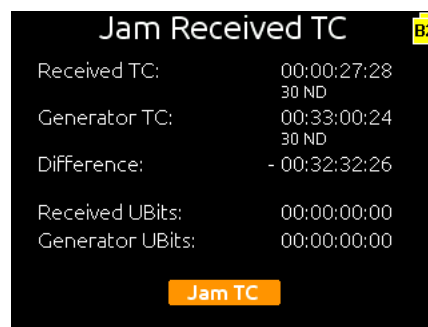

To manually jam the timecode:

- ▶ From the Timecode Jam menu, press the Headphone encoder.

To exit the Timecode Jam menu without jamming:

- ▶ Press either the MENU or METERS button.

Setting the Timecode Generator

Timecode values may also be manually set.

To set the timecode generator:

1. Press the MENU button.
2. Turn and press the Headphone encoder to select TIMECODE > Set Generator TC.

The Set Generator TC screen appears with four fields representing hours (HH), minutes (MM), seconds (SS), and frames (FF).

3. Navigate the screen's fields by doing the following:
 - ▶ Turn the encoder to move orange highlight from one field to the next.
 - ▶ Press the encoder to select a field. Chosen fields appear blue.
4. Turn and press the encoder to change each field's value.
5. When finished with your edits, turn the encoder to highlight Done and press the encoder to save your new timecode value.

Setting User Bits

By default, you may customize the user bits with a four-field format, delineated by colons, such as UU:UU:UU:UU, where U represented a user-definable value.



Often, the first three fields in the format are manually reset daily using two-digit numerical values for the date, such as MM:DD:YY:UU or DD:MM:YY:UU.

The User Bits mode lets you configure the device to automatically populate the first three fields with values derived from the system's date.

A fourth mode allows user bits to be derived from an external source. If that mode is to be used, ensure the external source for timecode user bits is attached to the 633 via the 5-pin LEMO connector on the mixer's right panel before setting the mode.

To set User Bits mode:

1. Press the MENU button.
2. Turn and press the Headphone encoder to select TIMECODE > Set Generator UBits.
3. Press the encoder again to select one of four mode options:
 - UU:UU:UU:UU — four, two-digit, user-definable fields (the default)
 - MM:DD:YY:UU — first three two-digit fields represent month, day, year
 - DD:MM:YY:UU — first three two-digit fields represent day, month, year
 - Use External — After the values are received from the external source, it may be disconnected from the mixer. The 633 will retain those values for up to two hours after power down.

① *When set to MM:DD:YY:UU or DD:MM:YY:UU, the system will populate the first*

three fields, so those fields will appear grayed out in the Set Generator UB screen, leaving only the last field (UU) to be customized by the user. When set to Use External, the fields appear grayed out and the field labels change from UU to XX.

Setting Display Mode

By default, the timecode is displayed as the largest clock on the screen in meter views. However, you may reverse the positioning of the timecode and absolute time clocks on all meter views so that the one you deem most important is larger.

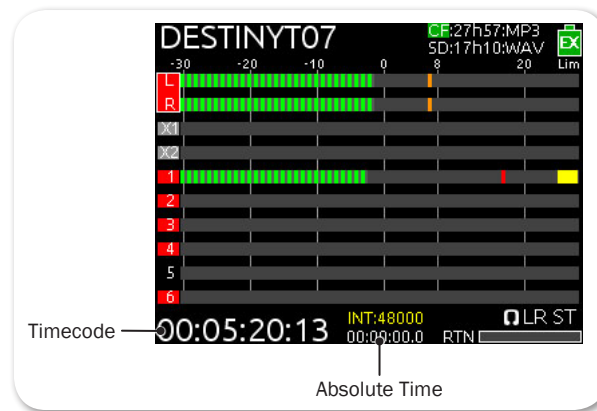

To reverse the clock display:

1. Press the MENU button.
2. Turn and press the Headphone encoder to select TIMECODE > Display Mode. Options include:

OPTIONS	DESCRIPTION
Big A-time	Displays absolute time as the larger clock in all Meter Views.
Big Timecode	Displays the timecode as the larger clock in all Meter Views.

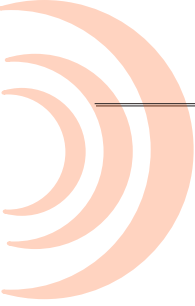

The 633 has multiple options for file management of the SD and CF cards. In this section of the guide, we discuss the file and folder structure, copying files from one media to another, transferring files from the CF or SD card to a computer, formatting media and generating CSV Sound Reports directly from the 633 interface.

Topics in this section include:

- ▶ File Structure
- ▶ Transferring Files to PC
- ▶ Take List and File List
 - ▶ Accessing the File List
 - ▶ Deleting Files or Folders
- ▶ File Storage Settings
- ▶ Setting Folder Options
- ▶ Generating Sound Reports
- ▶ Changing the Take Designator
- ▶ Defining File Max Size
- ▶ Setting Scene Increment Mode
- ▶ Setting Take Reset Mode
- ▶ Setting File Playback Mode
- ▶ Selecting a Default Playback Card
- ▶ Erasing / Formatting Media

File Structure

The 633 records polyphonic or monophonic audio files. Polyphonic recordings have multiple audio tracks within a single file. Monophonic recordings have a file for each audio track.

Polyphonic file names consist of a scene name, take number, and a file extension:

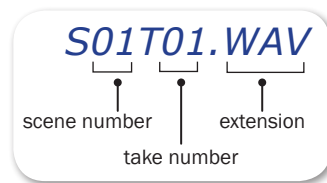

Monophonic file names consist of a scene name, take number, mono track designator, and a file extension:

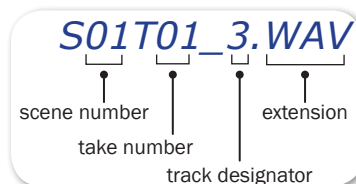

The track designators are associated with the 633 tracks. This differs from track names which may be edited and are covered in depth in the Metadata section of this guide. For more details, see [Editing Metadata on the 633](#).

This table illustrates the association between 633 tracks, track names, and track designators.

TRACK	TRACK NAME	TRACK DESIGNATOR
Track L	MixL	1
Track R	MixR	2
Track 1	Ch1	3
Track 2	Ch2	4
Track 3	Ch3	5
Track 4	Ch4	6
Track 5	Ch5	7
Track 6	Ch6	8
Track X1	Aux1	F
Track X2	Aux2	G

Transferring Files to PC

When finished recording, and the media remaining time on the Main screen is white, you may remove the SD or CF card(s) from the 633 and mount them to any computer to transfer your recorded files using a card reader or card slot.

To remove the SD card:

1. Open the Media Door.
2. Push it in to release the card, and then pull it out.

To remove the CF card:

- Open the Media Door and pull out the card.

To transfer files:

1. Mount your memory card to your computer.
2. Copy the files from the card to the computer.

① *Sound Devices recommends that you copy files first before editing files on the computer. Do not edit files directly from the memory cards.*

Take List and File List

A file is an individual file stored on attached media. A take is a single recording that can consist of multiple files on one or both media. The Take List displays a list of takes and provides functions for deleting, renaming, and editing information in metadata fields. Edits made in the Take List will be applied to both SD and CF cards, if applicable. For details on the Take List, see [Take List Overview](#).

Accessing the File List

The File List displays files and folders on a chosen media and provides functions for deleting files or folders, copying files or folders to other media, renaming folders, creating sound reports, formatting media, and emptying Trash and False Take folders. The File List functions only apply to the chosen media.

To access the File List:

1. Press the MENU button.
 2. Turn and press the Headphone encoder to select FILE STORAGE > File List.
- ① *An alternative way to access the File List is by sliding the MIC/TONE switch while the Take List screen is displayed. That switch acts as a toggle between the File List and Take List screens.*

The first screen displays each media and general information along with menu options.



3. Slide the RTN/FAV switch to access options for the card. Options include:
 - Create Sound Report
 - Copy to other card
 - Rename
 - Empty Trash
 - Erase/Format

If necessary, to return to the Card screen, press MENU.

4. Turn and press the Headphone encoder to select CF or SD and view its contents. A list of files on that card will be displayed. Folder names are preceded by a slash (“\”).

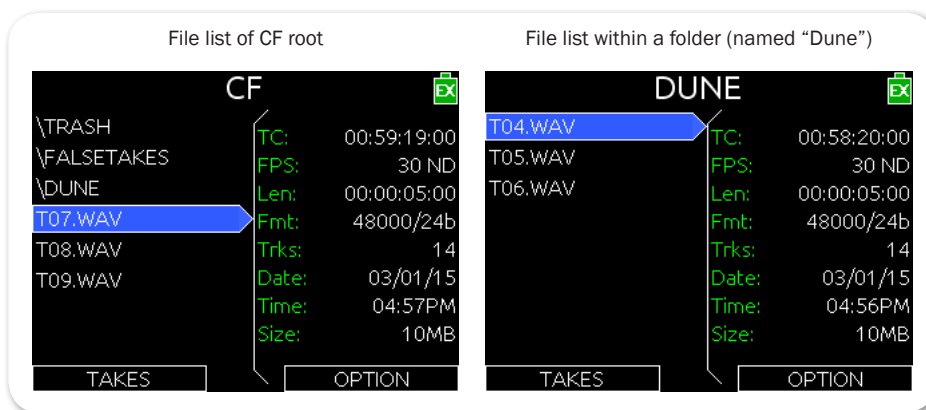

5. Turn the Headphone encoder to highlight a chosen file or folder. Information pertaining to your selection appears on the right.
6. Slide the RTN/FAV switch to access options. The OPTION menu will vary depending on the file or folder selected.

Folder options include:

- Create Sound Report
- Empty Folder (Trash and False Takes folders only)
- Copy Directory to other card
- Rename folder
- Delete folder from chosen card

File options include:

- Copy file to the other card
- Delete file from chosen media

Deleting Files or Folders

Files and folders may be deleted from the File List.

- ① *File deletion applies only to the chosen media. To delete all files associated with a take, use the Take List.*

To delete a file or folder:

1. From the File List, turn and press the Headphone encoder to select CF or SD. A list of files on that card will be displayed.
 2. Turn the Headphone encoder to highlight the chosen file or folder.
 3. Slide the RTN/FAV switch left or right to access options for the highlighted file or folder.
 4. Turn and press the Headphone encoder to select Delete.
- ① *Delete is not an option when the Trash or False Takes folders are selected.*
5. Press the Headphone encoder to confirm deletion or turn and press the Headphone encoder to cancel deletion.

Deleted files get moved to the Trash folder of the chosen card.

File Storage Settings

The following table provides the File Storage settings and available options.

SUB-MENU	DESCRIPTION	OPTIONS
Take List	Accesses the Take List. See Take List Overview for more details.	
File List	Accesses the File List.	

SUB-MENU	DESCRIPTION	OPTIONS
Folder Options	Sets options for folder structure with up to three levels of hierarchy.	<ul style="list-style-type: none"> • Top-Level • Mid-Level • Bottom-Level
Sound Report Info	Enter information to be included in Sound Report headers.	<ul style="list-style-type: none"> • Project • Producer • Director • Job • Date • Location • Sound Mixer • Phone • E-Mail • Client • Boom Op • Prod. Co. • Prod. Co. Tel. • Mics • Comments • Roll • Media • File Type (CF) • File Type (SD) • Sample Rate • Frame Rate • Bit Depth • Tone Level
File Max Size	Selects the file size at which a recording will close automatically, and then start a new file.	<ul style="list-style-type: none"> • 4GB • 2GB • 1GB • 640MB • 512MB
Scene Increment Mode	Enables or disabled the scene increment shortcut and selects which format the scene increment will use.	<ul style="list-style-type: none"> • Disabled • Character • Numeric
Take Reset Mode	Defines when take number is reset.	<ul style="list-style-type: none"> • Never • Scene Change • Daily Folder Change • Either Scene or Daily
File Playback Mode	Determines what (if any) playback action the 633 will perform upon reaching the end of a file during playback.	<ul style="list-style-type: none"> • Play Once • Play All • Repeat One • Repeat All
Default Playback Card	The source media that files will be played from when playback is initiated.	<ul style="list-style-type: none"> • CF • SD
Erase/Format CF	Formats CF card to FAT32 (32 GB or less) or exFAT (greater than 32 GB) file system.	
Erase/Format SD	Formats SD card to FAT32 (32 GB or less) or exFAT (greater than 32 GB) file system.	

Setting Folder Options

By default, recorded files are written to the root level of the SD and CF card. Three levels of directories can be configured from Main menu option FILE STORAGE > Folder Options. Folder choices include Top-Level, Mid-Level, and Bottom-Level. Folders are created when the record key is pressed.

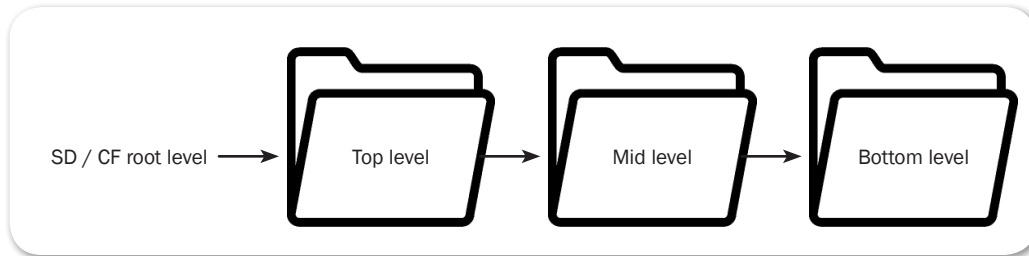

Each folder level has a corresponding list of available names that can be edited manually. When a folder level is manually named, all subsequent recordings will be written to that folder until the Folder option is changed.

To manually set the name of a folder level:

1. Press the MENU button to access the Main menu.
2. Turn and press the Headphone encoder to select FILE STORAGE > Folder Options.
3. Turn and press the Headphone encoder to select a folder level. Options include: Top-level, Mid-level, or Bottom-level.
4. Turn and press the Headphone encoder to select <Add New Entry>.
5. Use the on-screen keyboard (or a USB keyboard, if attached) to enter a value.
6. (Optional) If you mistype while entering a value, slide the RTN/FAV switch left to "backspace" and remove the mistyped text.
7. (Optional) Slide the MIC/TONE switch to toggle between uppercase and lowercase characters, if necessary.

① *On-screen keys are grayed out for symbols that are not permissible.*

8. Slide the RTN/FAV switch right to accept the new value.

In addition to custom entries, the Mid-level folder may be set to <Daily> and the Bottom-level folder may be set to <Scene>:

- When the Mid-level folder is set to <Daily>, a folder will be created automatically and named according to the date. Whenever a new day occurs, the 633 will prompt the user to confirm the creation of a new daily folder.
- When the Bottom-level folder is set to <Scene>, a new folder will be created each time the scene name is changed.

① *The top level folder value is stored in the Project field of metadata.*

The mid level folder value is stored in the Roll (Tape) field of metadata.

Generating Sound Reports

The 633 can generate sound reports as a comma separated values (CSV) file. CSV files can be opened and edited by any common spreadsheet application such as Microsoft® Excel®, OpenOffice™ Calc, Apple® Numbers, Google Docs™, and many more. Ensure the spreadsheet application is set to delineate by comma.

① *MP3 files are not included in sound reports.*

To define headers for sound reports:

1. Press the MENU button.
2. Turn and press the Headphone encoder to select FILE STORAGE > Sound Report Info. A list of sound report headers appears.
3. Select a header to edit.
4. Do one of the following:
 - ▶ Use the Headphone encoder to select an existing item from the list.
 - ▶ Use the Headphone encoder to select <Add New Entry>. Then use the on-screen keyboard to enter a new value.

① *Other options include: <None>, <Current Selection>, and <System Date>.*

Sound reports are generated by folder. All files in the folder are included in the sound report. Files located within sub-folders will not be included in the sound report. For example, if you have a Mid- and Bottom-level folder, you have to create a sound report on the bottom level where the files are located.

To generate a sound report:

1. Access the File List. See [Accessing the File List](#) for details.
2. Turn the Headphone encoder to highlight the folder in which you would like to generate a sound report.
3. Slide the RTN/FAV switch right to access the options menu for this folder.
4. Turn and press the Headphone encoder to select Create a Sound Report. A .csv file will be created in the folder with a name of:
[FOLDER NAME]_REPORT.CSV.
5. When prompted for confirmation, press the Headphone encoder to confirm.

① *Sound reports may also be initiated from the Wingman app on mixers with the WM-Connect Bluetooth Smart USB accessory. For more information, see [Wingman Integration: 6-Series](#).*

Changing the Take Designator

The default take designator of file names is the capital letter T, but that may be changed to a hyphen or any letter of the alphabet.

To change the take designator:

1. Press MENU.
2. Select FILE STORAGE > Take Designator.
3. Select a new capital letter or a hyphen to be the take designator.

The change will apply to all future files; it does not affect existing files.

Defining File Max Size

By default, the maximum size of WAV files is 4GB. When the max file size is reached, the file is split and a new file is written automatically. This split is seamless and sample-accurate.

① *When recording MP3 files, splits will not be seamless.*

To set maximum file size:

1. Press the MENU button.
2. Turn and press the Headphone encoder to select FILE STORAGE > File Max Size.
3. Turn and press the Headphone encoder to set a maximum file size. Options include: 4 GB, 2 GB, 1 GB, 640 MB, and 512 MB.

If longer recording times with less splits are wanted, various options affect this:

- Record mono WAV files rather than poly WAV files. See [Setting File Type and Media Track Assignment](#) for details.
- Lower the sample rate. See [Setting the Sample Rate](#) for details.
- Lower the amount of armed tracks (poly only). See [Arming or Disarming Recording Tracks](#) for details.

Setting Scene Increment Mode

The 633 provides a Scene Increment shortcut, but it is disabled by default. Scene names will not increment unless the Scene Increment mode is enabled. See [Shortcuts](#) for a description of all time-saving shortcuts.

To enable Scene Increment mode:

1. Press the MENU button.
2. Turn and press the Headphone encoder to select FILE STORAGE > Scene

Increment Mode. Options include:

OPTIONS	DESCRIPTION
Disabled	Shortcut is disabled.
Character	When set to Character, and the scene name ends with a letter, the Scene Increment shortcut will change that letter to the next letter of the alphabet. If current scene name does not end in a letter, a letter will be appended.
Numeric	When set to Numeric, and the scene name ends with a number, the Scene Increment shortcut will increment that number to the next numerical value. If current scene name does not end in a number, a number will be appended.

Setting Take Reset Mode

Takes are labeled numerically in the file name, preceded by the letter T, and stored in the metadata of each recorded file. Take labels begin at number 01 and continue to increment by one until they are reset. By default, take numbers reset when a new scene is selected or when a new daily folder is created. This behavior can be modified to only happen when the daily folder changes, only happen when the scene changes, or to never happen.

To set take reset mode:

1. Press the MENU button.
2. Turn and press the Headphone encoder to select FILE STORAGE > Take Reset Mode. Options include: Never, Scene Change, Daily Folder Change, or Either Scene or Daily.

Setting File Playback Mode

When playback is initiated, the selected file will play to the end and then stop—unless, of course, playback is stopped prematurely by manually pressing the Transport control in twice. This default behavior is called Play Once, but it may be modified so that all files in the folder will be played (Play All), the selected file will play in a loop until stopped (Repeat One), or all files in the folder will be played in a loop until manually stopped (Repeat All).

To set file playback mode:

1. Press the MENU button.
2. Turn and press the Headphone encoder to select FILE STORAGE > File Playback Mode. Options include: Play Once, Play All, Repeat One, or Repeat All.

Selecting a Default Playback Card

By default, the CompactFlash memory card is the playback card. If no CF card is present, the SD card will be used. The default playback card is indicated with a green background on the main view:

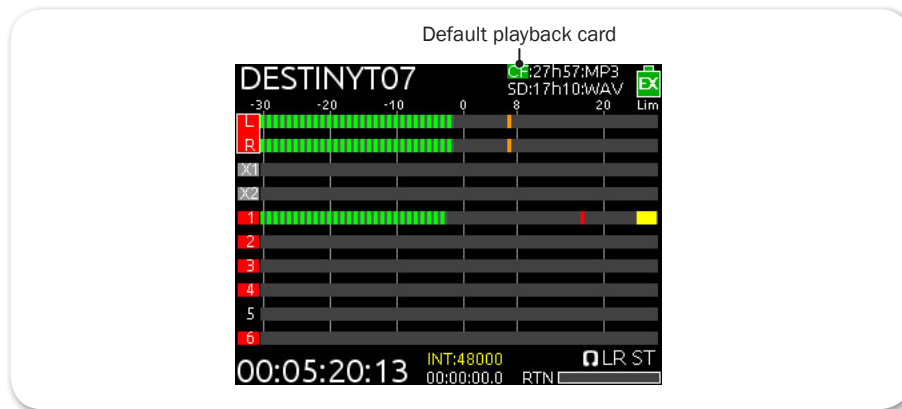

To set the default playback card:

1. Press the MENU button.
2. Turn and press the Headphone encoder to select FILE STORAGE > Default Playback Card. Options include: CF or SD

① *An alternative way to set the default playback card is to press in and hold the Headphone encoder while pushing down on the Transport control.*

Erasing / Formatting Media

Before recording to CF or SD media, cards must be formatted by the 633.

To format media:

1. Press the MENU button.
2. Turn and press the Headphone encoder to select FILE STORAGE.
3. Do either of the following:
 - ▶ Select Erase/Format CF to reformat a CompactFlash card.
 - ▶ Select Erase/Format SD to reformat an SD, SDHC, or SDXC card.
4. Press the Headphone encoder to begin the formatting process.

Formatting media will erase all data on the card.

5. Follow the message(s) that appear on screen and press the Headphone encoder to continue.
6. Press the METERS button to return to the Main screen.

Cards with a capacity of 32 GB or less will be formatted with the FAT32 file system. Cards with a capacity greater than 32 GB will be formatted with the exFAT file system.

- ① *The exFAT file system is not compatible with Windows XP or Mac OS X 10.6.4 or lower.*

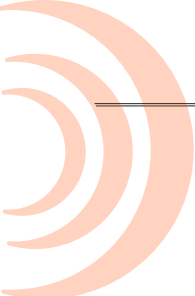

Metadata is used to convey the details or content of a recording. A take can consist of multiple metadata files.

The 633 Take List allows the sound mixer to enter and edit the metadata of broadcast WAV files, such as Scene, Take, Notes, Track Names, and Circle Status.

Applications that can read Bext and iXML data will display the metadata of files generated by the 633. Metadata can also be used to generate a Sound Report in CSV file format directly from the 633.

① *Editing metadata may be done directly through the mixer's interface or via the Wingman app. For more information, see [Wingman Integration: 6-Series](#).*

Topics in this section include:

- ▶ Take List Overview
 - ▶ Accessing the Take List
- ▶ Playing Takes
- ▶ Editing Metadata on the 633
- ▶ Using the Phrase List for Notes
- ▶ Clearing Scene List
- ▶ Metadata Overview
- ▶ Renaming or Deleting Previous Takes
- ▶ Editing Metadata in Other Programs

Take List Overview

The Take List displays all tracks recorded across both media.

By default, when a recording is made, the name of the file is the take number, such as T01.wav. From the Take List, a user can enter a scene name for the next take so that when the recording occurs, the file name contains both scene and take.

In the Take List screen, takes are listed in the left column in the order they were recorded. The top item in orange text indicates the next take. The right column displays details about the highlighted take.

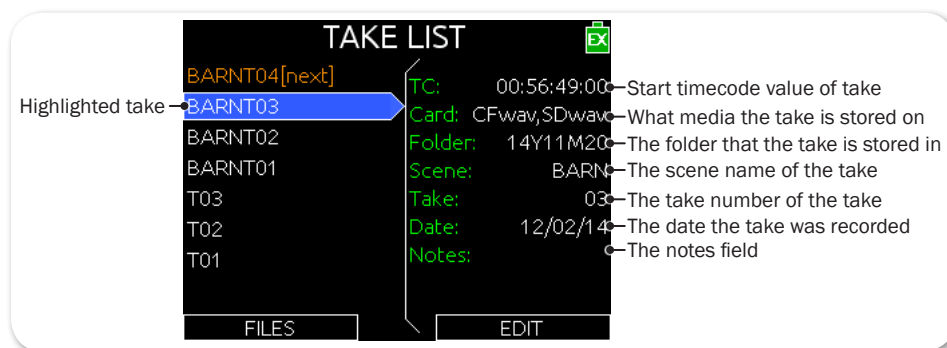

In the example, the highlighted take is known as the current take. Edits made to the current take will be applied to the next take and subsequent recordings that follow. Previous takes are listed below the current take.

Accessing the Take List

There are two ways to access the Take List. One way is via the Main menu's FILE STORAGE sub-menu. The other is provided in the following procedure.

To access the Take List:

1. MENU + HP: Press and hold the MENU button and Headphone encoder. The Take List screen appears.
2. Turn the Headphone encoder to highlight takes and view details in the right column.
3. Press the METERS button to exit or close the Take List screen.

Playing Takes

Playback of a take may be initiated from the Take List.

To play a take from the Take List:

1. MENU + HP: Press in the MENU button and Headphone encoder together to view the Take List screen.
2. Turn the Headphone encoder to highlight a take to play.
3. Push down the Transport control to begin playback. The Main screen is displayed, and playback begins.

Editing Metadata on the 633

Notes, Scene, Take, Circle Status, Folder (tape), Project, and all track names may be edited directly from the Take List for next or previous takes.

- ① *The term "file" refers to a single file on one medium, but the term "take" refers to a recording which may consist of multiple files with identical content on different media. Editing a take in any way will affect all files associated with that take.*

To edit metadata from the Take List:

1. MENU + HP: Press and hold the MENU button + Headphone encoder together to view the Take List screen.
2. Turn and press the Headphone encoder to choose a take to edit. A list of metadata parameters appears.

① *Selecting the take at the top of the list (orange text and indicated by [NEXT]) will set metadata value for future takes. Selecting any other takes in the list will edit metadata for existing takes.*
3. Turn and press the Headphone encoder to choose what metadata to edit.

4. Some parameters are text-based, numeric-based, or a list of options. When editing, do one of the following:
 - ▶ For text fields, use the on-screen keyboard (or an optional USB keyboard if attached) to enter text. When finished, slide the RTN/FAV switch right to accept the value.
 - ① *The Scene field is a unique text field, allowing the user to <Add New Entry> or select from a list of previously created entries. There is also an option to clear the list. For more information, see [Clearing Scene List](#).*
 - ▶ For numeric fields, use the Headphone encoder to edit the value. When finished, select Done.
 - ▶ For list fields, use the Headphone encoder to select a value.
 - ① *The Notes metadata field is a text field to provide extra information about a take that is not accounted for with other metadata fields. Notes may be created in manually for each take, using the on-screen keyboard; however, the field has the additional <Use Phrase> option, which may be selected for quick access to a user-definable list of common notational phrases.*

Using the Phrase List for Notes

Often, the same word or phrase is used for Notes on many different takes. To save time on metadata entry, the 633 provides the ability to create a phrase list for rapid retrieval and usage.

To access the phrase list and add new entries:

1. HP + FAV: Push in and hold the Headphone encoder then slide the RTN/FAV switch to the right. The Phrase List screen appears.



2. Slide the switch right again to add a new entry in the list.
3. Use the on-screen keyboard (or an optional USB keyboard if attached) to enter the new word or phrase. While entering data with the on-screen keyboard, any of the following steps may also apply:
 - Use the MIC/TONE switch to toggle upper and lower case.
 - If a mistake is made, slide the RTN switch left to backspace; this erases text left of the current cursor position.
 - Use the Select encoder to reposition cursor without removing any text already entered.

- Slide the FAV switch right to select OK and save the new entry.

To edit or delete a phrase list entry:

- Access the Phrase List screen.
- Turn the Headphone encoder to highlight an entry.
- Do either of the following:
 - ▶ Slide the MIC/TONE switch left to delete the chosen entry.
 - ▶ Slide the MIC/TONE switch right to edit the chosen entry.
- Select OK to approve changes or confirm deletion.

To use a phrase from the phrase list:

- Access the Phrase List screen.
- Turn the Headphone encoder to navigate the list.
- Push in the Headphone encoder to apply the selected phrase.

During standby, the mixer applies the selected phrase to the last take recorded. While recording, however, a selected phrase is applied to the currently recording take.

① *The Phrase List screen is not available during playback.*

Clearing Scene List

When editing a take's scene, the metadata entry becomes part of a Scene list, making it easier to simply select from the list of commonly used scene names.

However, should it be necessary to clear the list, there is an option available that clears the entire list for the next take instead of having to delete each scene name from the list individually.

To clear the Scene list:

- MENU + HP: Press MENU and Headphone encoder simultaneously. The Take List screen appears.
- Select the next take.
- Slide RTN/FAV switch to edit the next take.
- Turn and press the Headphone encoder to select Scene. The list will appear.
- Select the <Clear List> option from the listed options.
- When the Confirmation dialog appears, select OK to confirm.

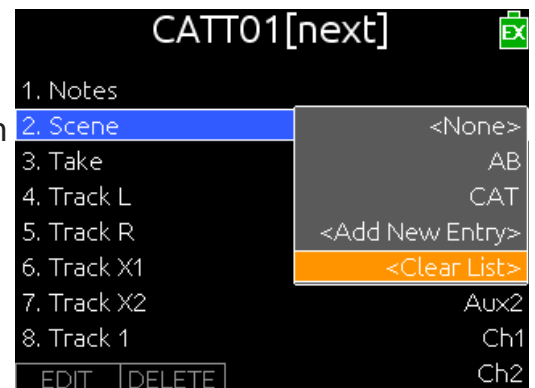

Metadata Overview

On the 633, broadcast WAV files include iXML data and bEXT chunk data. For applications that don't recognize bEXT or iXML, this information is ignored. The following chart details the supported metadata parameters.

METADATA PARAMETER	STORED IN	SET BY (U = USER, M = MACHINE)
Project	iXML	U; FILE STORAGE > Folder Options > Top-Level or Take List
Roll (Tape)	iXML, bEXT	M; uses creation date or is overridden by User U; FILE STORAGE > Folder Options > Mid-Level or Take List
Scene	iXML, bEXT	U; Take List
Take	iXML, bEXT	M or U; Take List
Notes	iXML, bEXT	U; Take List
Circle Take	iXML	U; Take List
File UID	iXML	M; Unique File Identifier
File Sample Rate	iXML, FMT	U; RECORDER > Sample Rate
Digitizer Sample Rate	iXML	U; Actual sample rate of AD converter
Bit Depth	iXML, FMT	U; RECORDER > Bit Depth menu
Channels	iXML, FMT	U; Number of channels (tracks) in the file
Frame Rate	iXML, bEXT	U; TIMECODE/SYNC > Frame Rate
TC Flag (ND or NDF)	iXML, bEXT	U; TIMECODE/SYNC > Frame Rate
Start Time Code	iXML, bEXT	M; Stored as a sample count since midnight
Duration		M
U-Bits	iXML, bEXT	U; TIMECODE/SYNC > Set Generator UBits
Time Code Sample Rate	iXML	M
Channel Index	iXML	M; Track Number
Interleave Index	iXML	M
Track Name	iXML, bEXT	U; Take List
Master Speed	iXML	M
Current Speed	iXML	M
Speed Note	iXML	M
Originator	bEXT	M
Creation Date	bEXT	M
Creation Time	bEXT	M
Originator Reference	bEXT	M
Software Version	bEXT	M
Family UID	iXML	M; shared by files belonging to the same take
Total Files	iXML	M; number of files representing a take
File Set Index	iXML	M
Original File Name	iXML	M

Metadata is included in MP3 files inside the ID3 tags. Metadata in MP3 files can not be edited with the 633. The following table shows the ID3 fields that metadata is stored in and the format in which it is stored.

① *Square brackets denote variables and are not included in actual metadata.*

ID3 FIELD	FORMAT
Artist Name	TC=[HH:MM:SS:FF]
Track Title	SC=[scene name] TK=[take number]
Album Title	FR=[frame rate] D=[duration]

Renaming or Deleting Previous Takes

Previous takes can be renamed or deleted from the Take List. When a take is renamed or deleted, the action applies to all files associated with that take on both media.

To rename a take:

1. MENU + HP: Press in the MENU button and Headphone encoder together to view the Take List screen.
2. Turn the Headphone encoder to choose a take from the list. This does not apply to Next takes.
3. Turn and press the Headphone encoder to select Rename. Enter a value using the on-screen keyboard or an optional USB keyboard, if attached.
4. When finished, slide the RTN/FAV switch right or press Enter on the attached USB keyboard.

To delete a take:

1. MENU + HP: Press in the MENU button and Headphone encoder together to view the Take List screen.
2. Turn and press the Headphone encoder to choose a take to delete.
3. Turn and press the Headphone encoder to select Delete.
4. Press the Headphone encoder to confirm deletion (OK).

① *Turn and press the Headphone encoder to select Cancel should you want to exit without deleting the take.*

Editing Metadata in Other Programs

Since Sound Devices recorders write metadata to WAV files using the Broadcast Wave File standard, many professional applications can read and edit this metadata. Sometimes, it is useful to edit metadata in bulk after recording and before sending the files to post-production.

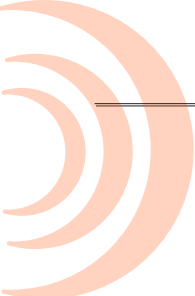

The 633 SYSTEM sub-menu allows for setup and control of various key system settings, such as tone or bell levels, date and time parameters, meter ballistics and more.

This sub-menu also provides access to viewing product version information and conducting firmware updates.

Some System settings, such as those related to headphones, Meter Views, or the LCD, are described in more detail in others sections of this guide where applicable. This section provides information for System settings not already covered elsewhere.

Topics in this section include:

- ▶ Setting up Tones and Bells
 - ▶ Configuring Record/Stop and Warning Bells
- ▶ Configuring the Meters
 - ▶ Setting Meter Ballistics and Peak Hold
 - ▶ Setting Peak Hold
- ▶ Setting up Date and Time Parameters
- ▶ Calibrating Faders & Pans
- ▶ Using a USB Keyboard
- ▶ Viewing Shortcut Information
- ▶ Viewing User Guide via QR Code
- ▶ Viewing Version Information
- ▶ Updating Firmware

Setting up Tones and Bells

The 633's internal tone oscillator, used for sending tone to outputs and tracks, has several settings to accommodate different workflows.

Activating tone is explained in more detail in the [Sending Tone to Outputs](#) section of this guide.

To define tone settings:

1. Press the MENU button.
2. Turn and press the Headphone encoder to select SYSTEM.
3. Configure the tone oscillator by modifying the following parameters.

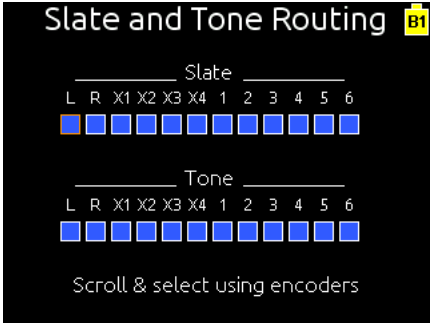
PARAMETER	DESCRIPTION	OPTIONS
Slate & Tone Routing	<p>Displays the Slate and Tone Routing screen where the tone signal can be routed to any output or track.</p>  <p>By default, all outputs and tracks are selected. For information on using the Slate section of the Slate and Tone Routing screen, see Routing the Slate Mic.</p>	<ul style="list-style-type: none"> • Outputs: L, R, and X1-X4 • Tracks: L, R, X1, X2, and tracks 1-6
Tone Level	Sets the level of the internal tone generator. By default, this level is set to 0 dBu.	<ul style="list-style-type: none"> • 0-20 dBu (1 dBu increment)
Tone Frequency	Sets the audio frequency of the internal tone generator. By default, this frequency is set to 1000 Hz.	<ul style="list-style-type: none"> • 100-10000 Hz (10 Hz increment)
Tone Mode	<p>The option chosen for this mode becomes the primary action of the MIC/TONE switch, with the other option not chosen becoming the secondary action.</p> <ul style="list-style-type: none"> • The primary action defines what happens when the MIC/TONE switch is slid to the right. By default, this action is set to send a continuous tone. • The secondary action defines what happens when the SELECT encoder is pressed and held as the MIC/TONE switch is slid to the right. By default, this action is set to L Ident. 	<ul style="list-style-type: none"> • Continuous • L Ident

Configuring Record/Stop and Warning Bells

The start of a recording is indicated audibly by a single 440 Hz tone sent to the sound mixer's headphones. When recording is stopped two 220 Hz tones are sent. These audible alerts are called the Record/Stop and Warning bells.

Warning bells alert users with an audible tone when the mixer has encountered an error, such as low power.

The default decibel level for these bells is -30 dBFS, but that level may be changed in 1 dB increments from -60 to -12 dBFS, or turned off entirely.

To set the warning bell level:

1. Press the MENU button.
2. Turn and press the Headphone encoder to select SYSTEM > Warning Bell Level.

- Turn and press the Headphone encoder to set a new level. Options include: Off, -60 to -12 dbFS in 1 dB increments.

① *Setting the warning bell level also adjusts the level used for Record/Stop bells.*

By default, the Record/Stop bells are turned on, but they may be turned off.

To turn on or off the Record/Stop bells:

- Press the MENU button.
- Turn and press the Headphone encoder to select SYSTEM > Record/Stop Bell.
- Turn and press the Headphone encoder to enable or disable the bell. Options include: On or Off.

① *Disabling Record/Stop bells does not apply to Warning bells.*

Configuring the Meters

The meters displayed in Meter Views are configurable. For instance, the meters can be displayed as segmented or solid bars.

Additionally, the track names may be displayed to help identify the tracks in Meter Views.

To configure the meters:

- Press the MENU button.
- Turn and press the Headphone encoder to select SYSTEM > Meter Display Style.
 - ▶ To display segmented meters, set the style to Segmented.
 - ▶ To display meters as solid bars, set the style to Solid.
- Turn and press the Headphone encoder to select SYSTEM > Track Names in Meters.

Options include:

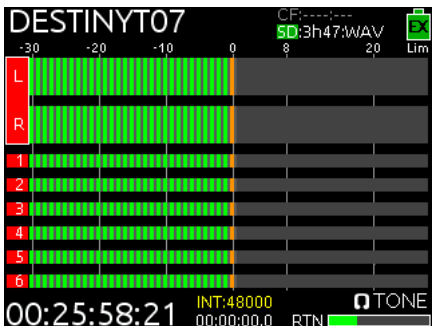
OPTION	DESCRIPTION	EXAMPLE
Off	Turns off the display of track names in meters. ① <i>The example shows segmented meters.</i>	

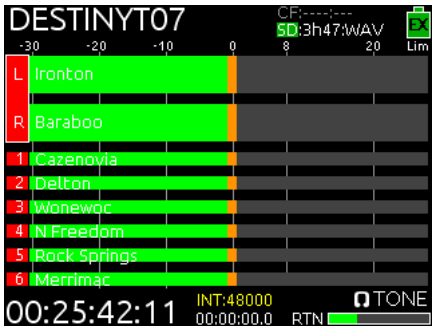
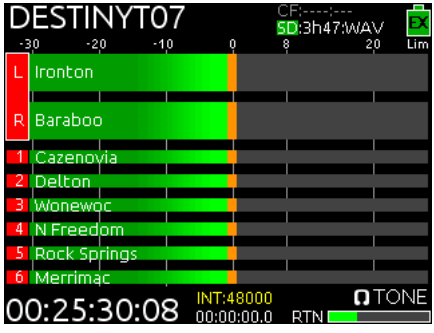
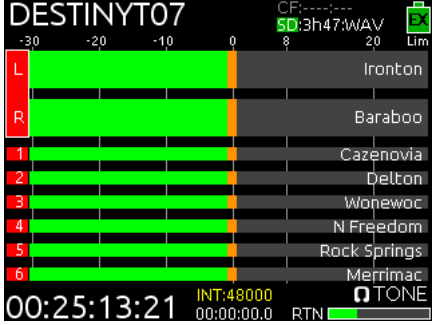
OPTION	DESCRIPTION	EXAMPLE
Left	Positions track names on the lower end of the meter scale. ① <i>The example shows solid meters.</i>	
Left w/ramp	Applies a gradient to the background color, and positions track names on the lower end of the meter scale.	
Right	Positions track names on the higher end of the meter scale.	

Setting Meter Ballistics and Peak Hold

Audio meter ballistics is the manner in which a visual meter responds to audio signal levels. The ballistics for all meters is globally set for the mixer via System settings.

To configure meter ballistics:

1. Press the MENU button.
2. Turn and press the Headphone encoder to select SYSTEM > Meter Ballistics.

Options include:

OPTIONS	DESCRIPTION
VU Only	Volume Units (VU) meter ballistics correspond closely to how the human ear perceives loudness. This provides a good visual indication of how loud a signal will be. In VU mode, the attack and decay of the meter signal is 300 mS. VU meters provide good visual indication of how loud a signal will be, but provide poor information of actual signal peaks.

OPTIONS	DESCRIPTION
Peak + VU	In Peak + VU mode, the perceived loudness (or VU) is simultaneously displayed as a standard bar while the peak signal is displayed as a single, independent segment above the VU.
Peak Only	Peak-reading ballistics (PPM) correspond to actual signal peaks, but do not necessarily correspond to perceived signal loudness. Peak meters have an instantaneous attack and a slow decay to allow visual monitoring of peak activity. Peak metering is useful in digital audio workflows. In the digital realm, signal overload can cause immediate distortion.

Setting Peak Hold

When meter ballistics is set to Peak + VU or Peak Only, peak hold displays the last highest peak value on the meter as a separate, individual meter segment. By default, this meter segment will remain visible for 1 second. This time frame is called the Peak Hold, and it may be adjusted or disabled altogether.

To modify the Peak Hold time for meters:

1. Press the MENU button.
2. Turn and press the Headphone encoder to select SYSTEM > Meter Peak Hold Time.

Options include:

OPTIONS	DESCRIPTION
1 - 5 sec	Sets the Peak Hold time to display the highest peak value for the selected time, from 1 to 5 seconds.
Infinity	Sets the Peak Hold time to display the last highest peak value indefinitely until a higher peak is reached.
Off	Does not hold peak values.

Setting up Date and Time Parameters

Properly setting the time and date is important for file metadata, file system functioning, and some timecode functions. Setting the correct GMT time zone and daylight savings values is also vital for correct data stamping on the exFAT file system.

The 633 has several System settings related to date and time parameters:

PARAMETER	DESCRIPTION	OPTIONS
Time Format	Sets the format used for times displayed by the mixer. By default the format is set to 12 hours.	<ul style="list-style-type: none"> • 12hr • 24hr
Date Format	Sets the format used to indicate the date, used in metadata. By default, the format is set to two-digit increments for month/day/year (mm/dd/yy).	<ul style="list-style-type: none"> • mm/dd/yy • dd/mm/yy • yy/mm/dd
Set Time/Date	Displays the Set Time/Date screen used to set the time and date.	

PARAMETER	DESCRIPTION	OPTIONS
Time Zone	Sets the time zone, based on Greenwich Mean Time (GMT).	<ul style="list-style-type: none"> • GMT-1:00 – -12:00 • GMT • GMT+1:00 – +13:00
Daylight Savings Time	Sets whether or not daylight savings is in effect. By default, daylight savings is off.	<ul style="list-style-type: none"> • On • Off

To set the formats for time and date:

1. Press the MENU button.
2. Do one of the following:
 - ▶ Turn and press the Headphone encoder to select SYSTEM > Time Format.
 - ▶ Turn and press the Headphone encoder to select SYSTEM > Date Format.
3. Turn and press the encoder to select a format option.
 - Time Format options include: 12hr or 24hr.
 - Date Format options include: mm/dd/yy, dd/mm/yy, or yy/mm/dd.

To set the time and date:

1. Press the MENU button.
2. Turn and press the Headphone encoder to select SYSTEM > Set Time/Date.
3. Turn the encoder to move the highlight to each of the time and date fields.

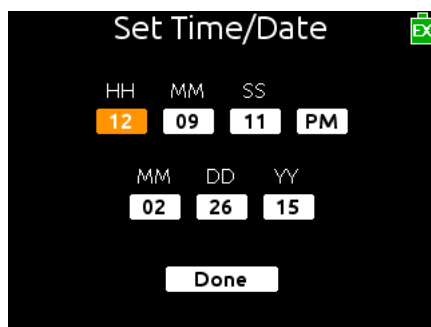

4. Press the encoder to select a field.
5. Turn the encoder to change the value of each selected field.
6. When finished modifying the time and date fields, turn and press the encoder to select Done.

To select the time zone:

1. Press the MENU button.
2. Turn and press the Headphone encoder to select SYSTEM > Time Zone.
3. Turn and press the encoder to select the proper GMT time zone for your location.

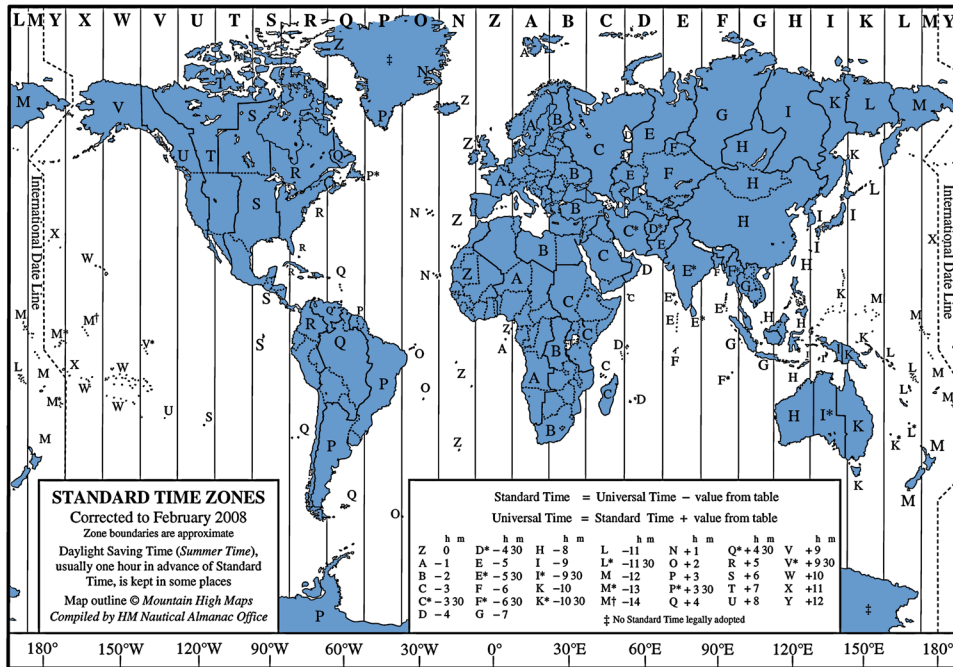

To enable or disable Daylight Saving Time:

1. Press the MENU button.
2. Turn and press the Headphone encoder to select SYSTEM > Daylight Saving Time.
3. Do one of the following:
 - ▶ To enable, turn and press the encoder to select On.
 - ▶ To disable, turn and press the encoder to select Off.

Calibrating Faders & Pans

The 633 Faders and Pan pots come pre-calibrated to center. However, should they ever need to be recalibrated, that can be done via a System settings sub-menu option.

To calibrate faders and pans:

1. Press the MENU button.
2. Turn and press the Headphone encoder to select SYSTEM > Fader/Pan Calibration.
3. Ensure all front panel controls are turned to the 12 o'clock position.
4. Press the Headphone encoder to select OK.

A "Calibration Successful" message appears when calibration is complete.

① *To cancel without calibrating, press the MENU button or use the Headphone encoder to select Cancel.*

Using a USB Keyboard

Included with the 633 is a USB 2.0 A (Female to Female) connector and a USB A to B cable, which may be used to connect a standard USB keyboard to the 633 mixer.

To use a USB keyboard with the 633:

1. Ensure SYSTEM > USB Port sub-menu is set to Keyboard.
 - ① *The USB Port is set to Keyboard by default; however, the alternative option is Factory Test, which is a setting reserved for the purposes of in-house quality assurance testing.*
2. Connect the keyboard's male USB A plug into the supplied USB A female adapter.
3. Connect the other end of the adapter to the USB A to B cable.
4. Plug the other end of the cable into the USB-B jack on the mixer's right panel.
 - ① *Keyboards with an embedded USB hub are not compatible. Apple brand keyboards are not compatible. Additionally, some keyboards must be connected only after the mixer is turned on.*

Keyboard shortcuts are provided in the [Shortcuts](#) section of this guide.

Viewing Shortcut Information

While this guide provides a section on the various shortcuts available with the 633, there is also an abbreviated list provided as a quick reference on the mixer itself.

To view shortcut information:

1. Press the MENU button.
2. Turn and press the Headphone encoder to select SYSTEM > Shortcut Info.
3. Turn the encoder to scroll down the list.
4. Press the encoder to select OK and exit the list.

Viewing User Guide via Smart Phone QR Code

The 633 provides QR codes on screen for smart phone access to product-related documentation, including this user guide, available online.

- ① *Accessing documentation via a QR code requires the installation on your smart phone of a code reader application—many of which are available as free downloads from App stores.*

To access the 633 User Guide via QR code:

1. Press the MENU button.
2. Turn and press the Headphone encoder to select SYSTEM > User Guide link.
3. Using your phones code reader application, scan the QR code to view the guide (PDF format).

Viewing Version Information

Information regarding the product's serial number, software and timecode versions, plus build numbers is provided on the mixer via a System settings sub-menu option.

To view version information:

1. Press the MENU button.
2. Turn and press the Headphone encoder to select SYSTEM > Version Info.

Updating Firmware

Periodically, Sound Devices, LLC releases firmware updates to improve system performance and expand the 633 feature set, which may be downloaded from the website and used to update the firmware on the mixer.

It is highly recommended that users update to the latest version of firmware available as soon as possible.

To update firmware:

1. Download the free firmware from the Sound Devices website to your computer.
2. Extract the ZIP file, which will contain a folder with a .prg file and related documentation.
3. Copy this .prg file to the root level of an approved SD or CF memory card. Do not place the file in any folder.

① *Be sure to use a memory card already formatted in the mixer.*

4. Insert the SD or CF card with the .prg file.
5. Power on the mixer if not already on.

Power the mixer from an external DC power source. Do not perform firmware updates with low batteries or unstable power sources.

6. Press the MENU button.
7. Turn and press the Headphone encoder to select SYSTEM > Update Firmware.

8. Follow the on-screen instructions.
9. After the update is complete, the mixer power cycles.

When it reboots, the updated version number will appear briefly on the splash screen, and the mixer displays a message confirming the firmware update.

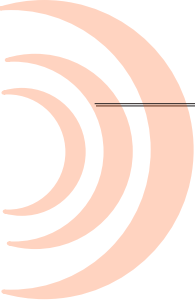

The 633 helps improve work-flow efficiency by providing users a way to save and load various custom configurations as Quick Setup XML files.

These Quick Setup files retain all settings made in the Main menu as well as adjustments made to all inputs (including routing) via the Input Settings screens.

Four configurations may be saved directly to the mixer; others may be saved to memory cards for use later.

Topics in this section include:

- ▶ Saving Settings
 - ▶ Copying Quick Setup Files
 - ▶ Deleting Quick Setup Files
- ▶ Loading Previously Saved Settings

Saving Settings

After you have configured the 633’s settings via the Main menu and Input Settings screens, you can save the configuration as a Quick Setup file.

To save settings as a Quick Setup file:

1. Press the MENU button.
2. Turn and press the Headphone encoder to select QUICK SETUP.
3. Select where you want to save your settings. Options include:

OPTION	DESCRIPTION
INT1 - INT4	Select one of the Save Settings to INT (1-4) options to store your configuration locally on the mixer. There are four internal (INT) locations. Each will hold one Quick Setup file. <div style="color: #27AE60; font-size: small;">① <i>New settings stored to an INT location will overwrite any Quick Setup file previously stored there.</i></div>
CF	Select Save Settings to CF to store your configuration on any CompactFlash memory card inserted into the 633.
SD	Select Save Settings to SD to store your configuration on any Secure Digital memory card inserted into the 633. <div style="color: #27AE60; font-size: small;">① <i>Saving to a CF or SD card will create a folder named SETTINGS, if it does not already exist.</i></div>

4. Name your Quick Setup file.
 - ① *When saving to CF or SD cards, if a file with the entered name already exists, that previous file will be overwritten by the new file you save.*
5. Slide the RTN/FAV switch to select OK and save your Quick Setup file.
All Quick Setup files are saved as XML files.

Copying Quick Setup Files

Quick Setup files saved on one memory card may be copied to another memory card as an additional backup.

To copy files from one memory card to another:

1. Press the MENU button.
2. Turn and press the Headphone encoder to select FILE STORAGE > File List.
3. Select the memory card with the file you want to copy.
4. Select the SETTINGS folder on that card.
5. Select the Quick Setup XML file you want to copy.
6. Slide the RTN/FAV switch to access OPTION.

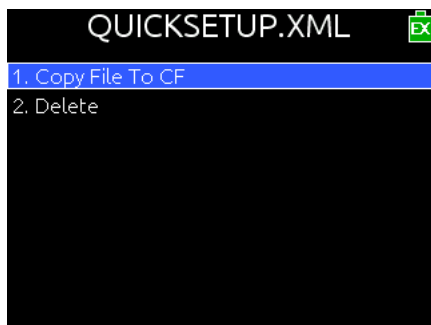

7. Select the Copy File ... option. The name of this option will vary depending on whether you are copying to a CF card or an SD card.

Deleting Quick Setup Files

Saving a new configuration to any of the internal (INT) locations will overwrite the previously saved file. The same applies to files saved to CF or SD cards so long as the file names match.

However, if you want to delete a file from a CF or SD card, you can do that without replacing it with a file of the same name.

To delete a file from a memory card:

1. Press the MENU button.
2. Turn and press the Headphone encoder to select FILE STORAGE > File List.

3. Select the memory card with the file you want to delete.
4. Select the SETTINGS folder on that card.
5. Select the Quick Setup XML file you want to delete.
6. Slide the RTN/FAV switch to access OPTION.
7. Select Delete.

Loading Previously Saved Settings

For fast reconfiguring of the 633, previously stored Quick Setup files may be easily loaded from internal locations or memory cards inserted into the mixer.

To load a Quick Setup file:

1. Press the MENU button.
2. Turn and press the Headphone encoder to select QUICK SETUP > Load Settings.

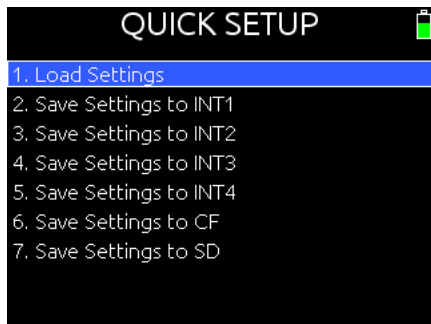

3. Select the file you want to load from the provided list.

① *The first option in the list reloads the Factory Default settings. Selecting this option restores all settings on the mixer to original factory defaults.*

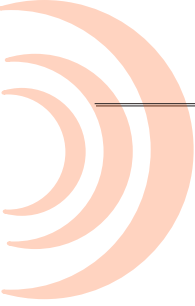

The 633 features numerous shortcuts to help speed navigation.



The shortcuts require either simultaneously pressing combinations of front panel controls or using keystroke combinations when a USB keyboard is attached to the mixer.

Topics in this section include:

- ▶ Front Panel Shortcuts
- ▶ USB Keyboard Shortcuts

Front Panel Shortcuts

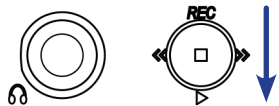
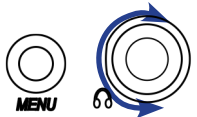
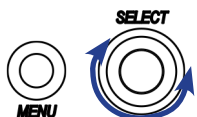
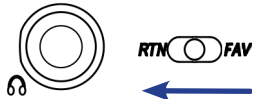
FUNCTION	SEQUENCE	ACTION
Arm/Disarm Track		<p>METERS + SELECT: Press and hold METERS then push in the Select encoder.</p> <p>This toggles the armed status of the highlighted track on the Main screen.</p>
File/Take List		<p>MENU + HP: Press and hold MENU then push in the Headphone encoder.</p> <p>This displays the Take List screen.</p>
False Take		<p>HP + << (Rewind): Press and hold the Headphone encoder then push the Transport control to the left.</p> <p>This moves the previous recorded file(s) to the False Takes folder and decrements the Take number.</p>
Scene Increment		<p>HP + >> (Fast Forward): Press and hold the Headphone encoder then push the Transport control to the right.</p> <p>This increments the scene name according to the Scene Increment Mode setting.</p>

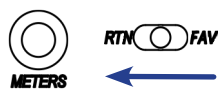
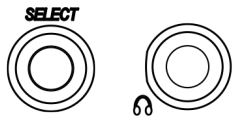
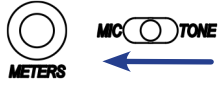
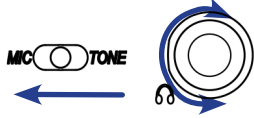
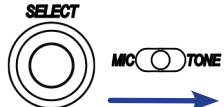
FUNCTION	SEQUENCE	ACTION
Toggle Playback Card		HP + Play: Press and hold the Headphone encoder then push the Transport control downward (Play). This toggles the playback media card between SD or CF. Target media is indicated by a green background on the Main screen.
LED Brightness		MENU + HP turn: Press and hold MENU then turn the Headphone encoder. This adjusts the brightness of all LEDs.
LCD Brightness		MENU + SELECT turn: Press and hold MENU then turn the Select encoder. This adjusts the back-light level of the LCD.
Scene Name		HP + RTN: Press and hold the Headphone encoder then slide the RTN/FAV switch to the left. This enables editing of the scene name. When used during recording, the current scene name is edited. During standby, when not recording, the next scene name is edited.
Current Take Phrase		HP + FAV: Press and hold the Headphone encoder then slide the RTN/FAV switch to the right. This accesses the phrase list and applies the selected phrase to the last take recorded (during standby) or to the currently recording take (during recording).
Toggle Sample/Frame Rate Display		METERS + RTN: Press and hold METERS then slide the RTN/FAV switch to the left. This toggles the display of timecode frame rate information and audio sample rate information.
Toggle LCD Daylight Mode		SELECT + HP: Press and hold Select encoder then press Headphone encoder. This toggles the LCD display between dark and light theme Daylight modes.
Jam Menu		METERS + MIC: Press and hold METERS then slide the MIC/TONE switch to the left. This accesses the TC Jam menu.
Slate Mic Gain		MIC + HP turn: Slide and hold the MIC/TONE switch to the left then turn the Headphone encoder. This adjusts the slate mic gain.
Alternate Tone Mode		SELECT + TONE: Press and hold the Select encoder then slide and briefly hold the MIC/TONE switch to the right. This engages tone using the alternative setting not presently configured as SYSTEM > Tone Mode.

USB Keyboard Shortcuts

A standard USB keyboard connects to the 633 to ease navigation and data entry. Attach the keyboard to the 633 USB port using a USB A to USB A adapter (included). Anytime the QWERTY pop up keyboard is displayed, the USB keyboard can be used to enter data.

Additionally, the following shortcuts are available.

- ① *Keyboards with an embedded USB hub are not compatible. Apple brand keyboards are not compatible. Some keyboards must be connected only after the mixer is turned on.*

KEYSTROKES	ACTION
F1 or Menu key	Accesses the Main menu.
F2	Accesses the Take List.
F3	Cycles between available Meters views and the Main screen.
Ctrl + R	Record.
Ctrl + S	Stop.
Spacebar	Play.
Left Arrow	Main screen: Rewind. Input Settings screen: Toggle phase inversion.
Right Arrow	Main screen: Fast forward. Input Settings screen: Toggle LR Mix assignment.
Up / Down Arrows	Main screen: Adjusts headphone volume. In menus: Moves highlight. While editing parameters: Changes the value.
Enter	Main screen: Accesses the HP Monitor Source list. In menus: Activates current selection. (Same as encoder press.)
Alt + Enter	Main screen: Toggles arming of selected track.
Ctrl + Enter	Access gain adjustment for highlighted L, R, X1, X2, X3, X4, X5, X6, or RTN track.
Ctrl + Up/Down Arrows	Main screen: Select tracks. Input Settings screen: Adjusts trim gain for inputs 7-12.
Ctrl + Left Arrow	Input Settings screen: Change X1 assignment.
Ctrl + Right Arrow	Input Settings screen: Change X2 assignment.

Wingman is an iOS-based application that provides wireless remote control and monitoring of any 6-Series field production mixer/recorder—the 688, 664, or 633.

It may be downloaded from Apple's App Store and installed on any iPad, iPhone, or iPod Touch mobile device, running iOS 8.0 or later.

The WM-Connect hardware accessory, a Bluetooth® Smart USB dongle for the 6-Series, is required for this integration.

① *Instructions for installing WM-Connect and downloading the Wingman app are provided in the [WM-Connect Quick Start Guide](#), shipped with the hardware and offered as a free PDF download from the [Sound Devices website](#).*

Topics in this section include:

- ▶ Starting Wingman
- ▶ User Interface
- ▶ Transport View
 - ▶ Connecting to a 6-Series Mixer
 - ▶ Using Transport Controls
 - ▶ Designating Circle and False Takes
 - ▶ Using Meter Views
 - ▶ Editing Track Names
 - ▶ Arming/Disarming Tracks
- ▶ Take List View
 - ▶ Editing a Take's Metadata
- ▶ Reports View
 - ▶ Creating Sound Reports
- ▶ About View
- ▶ Track View on iPhone or iPod Touch

Starting Wingman

Before starting the application, ensure the WM-Connect hardware accessory (shown at right) is attached to your 6-Series mixer, that Bluetooth is turned on (on your mobile device), and the mixer is both powered on and running the latest firmware.



To start the Wingman App:

- ▶ Tap the Wingman icon.



Setting up Wingman Password

For added security, when using the Wingman App to monitor and control the recorder from a mobile device, set up the 6-Series mixer to require a password for remote access. The password may be up to 18 alpha-numeric characters. Punctuation other than a hyphen or an underscore is not permitted.

To set a remote password:

1. Press the MENU button.
2. Turn and press the Headphone encoder to select SYSTEM > Wingman Password > Enter Password.

3. When the virtual keyboard appears, enter a password.
4. When finished, slide the RTN/FAV switch right (or Enter on attached USB-keyboard) to select OK.
5. When prompted to confirm, press the Headphone encoder to select OK again.

User Interface

The Wingman software application provides an easy-to-navigate, touch-screen user interface. However, because of variable screen sizes, views and some procedures differ depending on which mobile device is in use.

While both landscape and portrait orientation is supported on an iPad, this section describes the application's user interface and depicts images of the application as it appears (in portrait orientation) on an iPad.

① *For information pertaining to how the views and workflow differ on the smaller screens of an iPhone or iPod Touch, see [Track View on iPhone or iPod Touch](#).*

The main screen is divided into three parts: the status bar, the viewing area, and the tab bar.

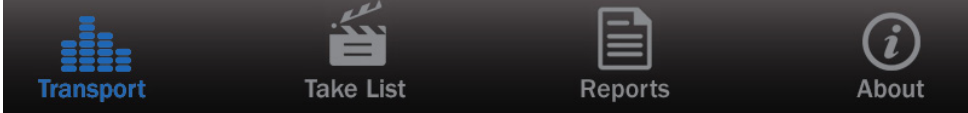
PART	DESCRIPTION
Status Bar	The status bar is device specific; therefore, it will vary in appearance based on the type of iOS mobile device being used. It often displays small, informative icons such as Bluetooth, WiFi, and battery power indicators.
Viewing Area	<p>This area, located between the status and tab bars, displays the different screen views of the Wingman application. The main screen is the Transport view, but others are available.</p> <p>The four views include:</p> <ul style="list-style-type: none"> • Transport - See Transport View for more information. • Take List - See Take List View for more information. • Reports - See Reports View for more information. • About - See About View for more information. <p>To select a view:</p> <ul style="list-style-type: none"> ▶ Tap the icon (on the tab bar) that corresponds to the required view. <p>On the main screen, there are multiple meter views available with the vertical swipe of a finger. See Using Meter Views for more information.</p>
Tab Bar	<p>This bar remains on-screen at all times and displays four icons, enabling access to the different screen views of the user interface. Each icon appears blue when that icon's corresponding view is displayed.</p> <div style="text-align: center;">  <p>The screenshot shows a dark grey tab bar at the bottom of the screen. It contains four icons from left to right: a blue bar chart icon labeled 'Transport', a clapperboard icon labeled 'Take List', a document icon labeled 'Reports', and an information icon labeled 'About'. The 'Transport' icon and its label are highlighted in blue, indicating it is the active view.</p> </div>

Status Bar

Viewing Area

Tab Bar

Transport View

The Transport view is subdivided into four sections, displaying the following:





SECTION	DESCRIPTION
Timecode	<p>This section (shown below) provides the current file name, as well as a bar with the following information:</p> <ul style="list-style-type: none"> • a large Timecode display • a Connection icon bearing the Sound Devices logo • a smaller ABS time display • the timecode frame rate  <p>When recording, the background color of the bar turns red.</p> <p>The color of the Connection icon changes depending on the status of the connection to the WM-Connect, and in turn the 6-Series mixer. See Connecting to a 6-Series Mixer for more information.</p>
Toolbar	<p>The toolbar (shown below) has four round buttons for—from left to right—Record, Stop, Circle Take, and False Take.</p>  <p>See Using Transport Controls and Designating Circle and False Takes for more information.</p>
Metadata	<p>This section bears the Wingman logo and provides text fields used to enter or edit metadata—such as scene name, take number, and notes—for both current and next takes.</p> <p>See Editing a Take's Metadata for more information.</p> <p><i>Due to smaller screen limitations, this section is not available in the application when used on the iPhone or iPod Touch. See Take List View for more information.</i></p>
Meters view	<p>Use this area to arm/disarm tracks, edit track names, and view meters. Because the Wingman app offers three pre-configured meter views, the meters shown will vary depending on the meter view and to which type of 6-Series mixer Wingman is connected.</p> <p>See Using Meter Views for more information.</p>

Connecting to a 6-Series Mixer

When running Wingman on an iPad, iPhone or iPod Touch, the Connection icon is located left of the Timecode display and bears the Sound Devices logo.

The color of the icon is significant, because it changes based on the connection status between the Wingman application on the mobile device and the WM-Connect Bluetooth® Smart USB accessory attached to a 6-Series mixer.

The color indicators are as follows:

COLOR	ICON	STATUS
Gray		Disconnected - either no activity or scanning for devices
Orange		Bluetooth connection in progress
Yellow		Connected - authentication underway
Green		Connected and authenticated

Connection to a 6-Series mixer with attached WM-Connect happens automatically when the Wingman application starts on a Bluetooth Smart-enabled iOS device. However, if more than one WM-Connect is within range, a Devices Found screen will appear, allowing you to select a mixer from the list.

- ① *If a remote password is configured on the recorder itself, Wingman will prompt for that password to be entered prior to making the connection. The password may be saved so that future connections to that same recorder will occur automatically. See [Using Bluetooth and Setting the Wingman Password](#) for more information.*

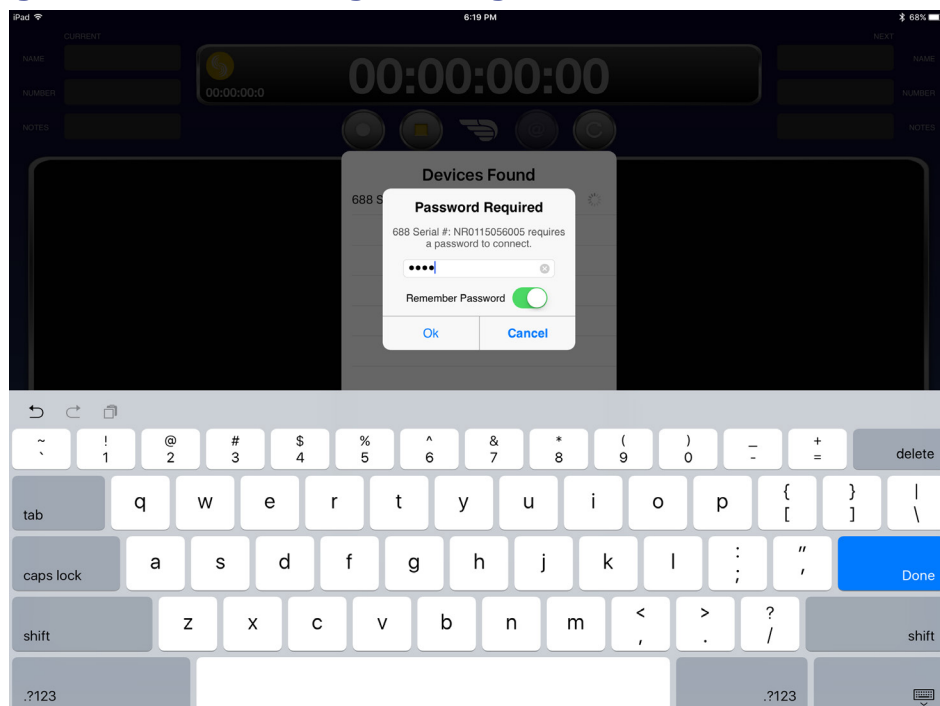

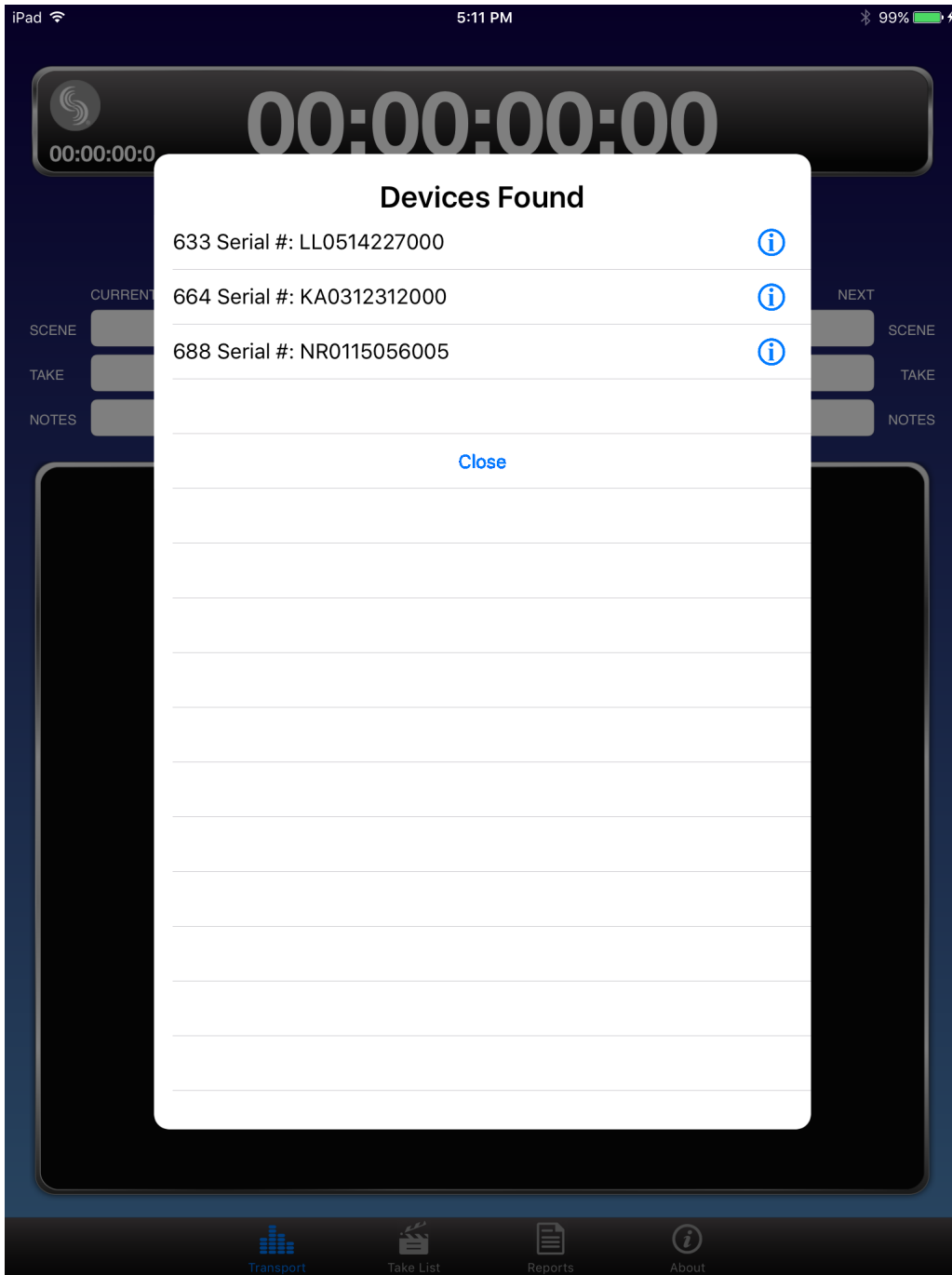

Use the Devices Found list to select a 6-Series mixer with a WM-Connect attached within range. Mixers that are within range but already connected to other Wingman applications are not visible in the Devices Found list.

To switch connection to a different 6-Series mixer:

1. Tap the Connection icon.
2. Select another mixer from the list of available devices.

① *For productions with multiple mixers of the same model, tapping the Circled-I icon helps identify the correct device, by displaying an "Identifying from Wingman" message on the chosen mixer's LCD.*

Using Transport Controls

When recording is in progress, the Transport view changes slightly. For instance, the background of the Timecode display appears red as does the center dot on the Record button.

To begin recording:

- ▶ Tap the Record button.

To stop recording:

- ▶ Tap the Stop button.

When stopped, the center dot on the Record button is white and the center square on the Stop button is yellow.

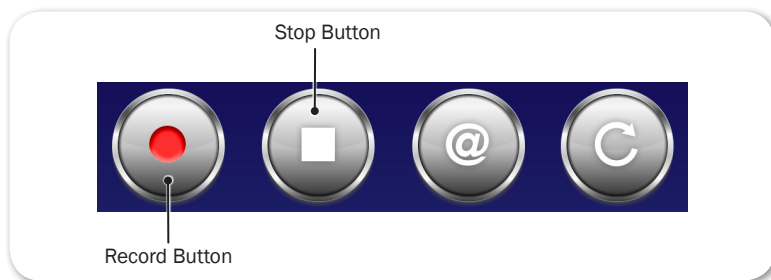

Designating Circle and False Takes

In the Transport view on the toolbar, there are buttons for circle and false takes.

Circling a take prepends the "at" symbol (@) to the take's filename and updates the file's metadata to "circled". Only the current recorded take may be circled using the Circle button; Previous takes can be circled in the Take list.

① *The current take cannot be circled while recording is in progress.*

To circle the current take:

- ▶ Tap the Circle button.

To circle a previous take:

- ▶ Tap Take List icon, select a previous take, and edit the Circled status from the take's Info screen.

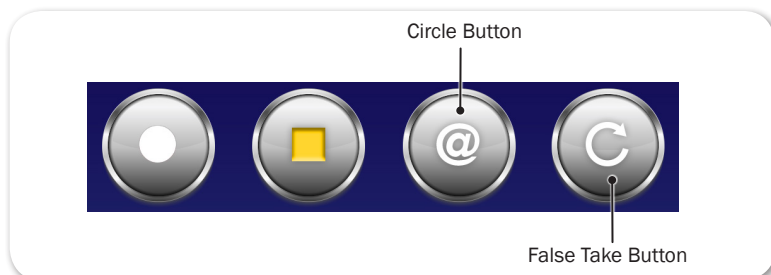

Designating a take as a false take moves the take to the mixer's False Takes folder and decrements the take number by 1. Only the current recorded take may be designated as a false take from the Transport view.

To designate the current take as a false take:

1. With recording stopped, tap the False Take button.
2. When prompted for confirmation to delete last take, select Delete.

This moves the current take into the mixer's False Take folder.

Using Meter Views

As part of the main screen, metering is displayed with track names superimposed over the meters. In Wingman, there are three pre-configured meter views available within the Transport view.

In most cases, meters appear vertically in the Transport view; however, on the 688 or 664 as shown below, when the left and right bus tracks are displayed with ISOs, only the ISOs (1-12) are vertical, while the left and right bus tracks (LR) are positioned horizontally.

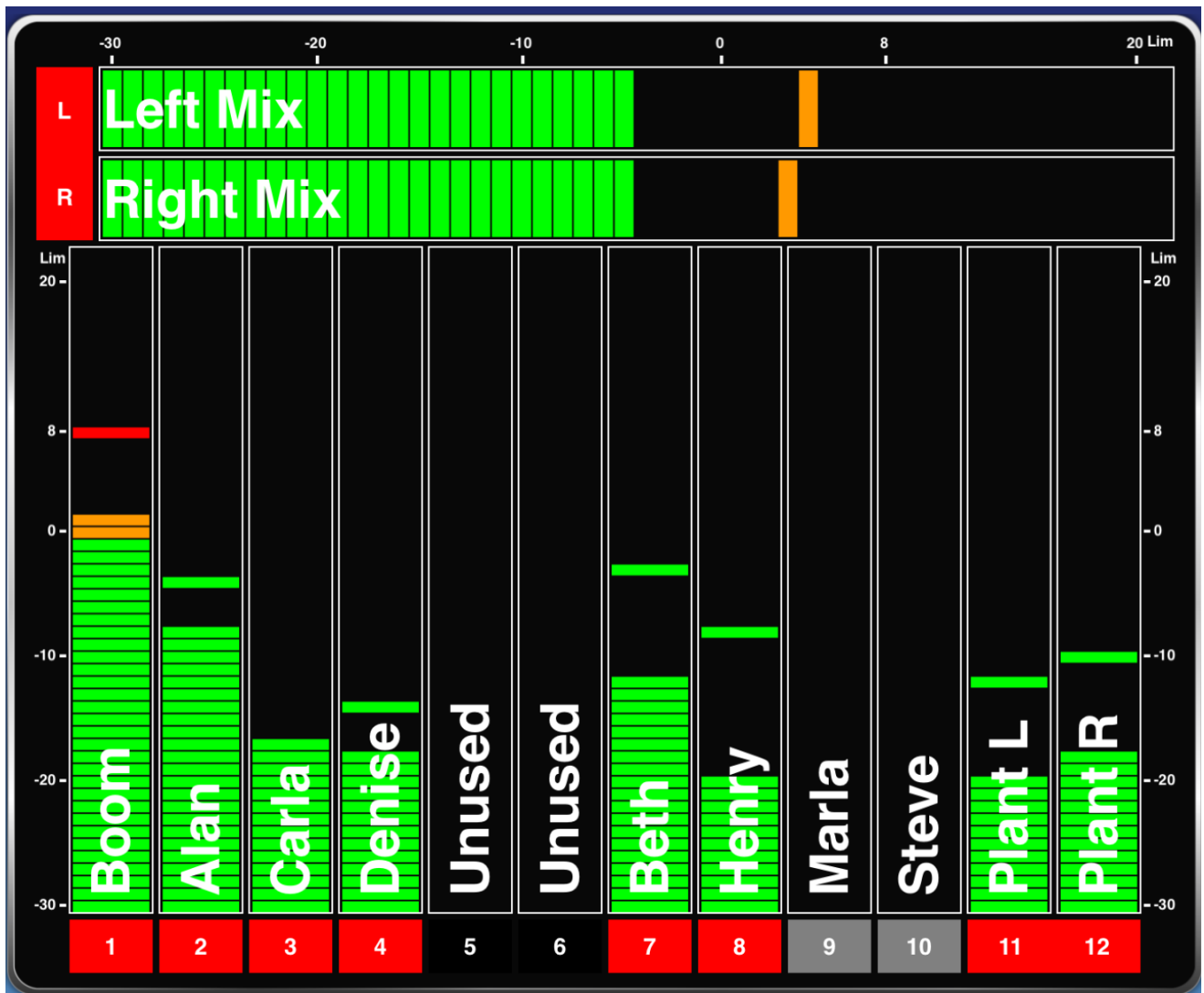

At the bottom of each vertical meter—or far left for horizontal meters—a rectangular label appears with a track identifier, such as L for left bus, 1 for Input 1, and so forth. The label's background color changes based on whether a track is on, off, armed or disarmed. For more information, see [Arming/Disarming Tracks](#).

Limiter indicators also appear on each meter when activated.

- ① *For the 688 only—circle icons also appear as activity indicators when either auto mixer, MixAssist™ or Dugan, is turned on.*

The three available meter views vary depending on the model of mixer to which Wingman is connected; however, the procedure for toggling through the available meter views is the same.

To change the meter view:

- ▶ Slide a fingertip vertically up or down over the meters.

The following table explains which pre-configured meter views are available for each model in the 6-Series mixer/recorder line.

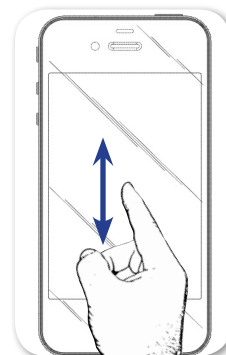

MIXER	METER VIEW	DESCRIPTION
688	LR, 1-12	This meter view shows left and right bus tracks as well as all 12 ISO tracks.
	LR, X1-X6	This meter view shows output signals of left, right, and X1 - X6.
	LR, X1, X2, RTNs	This meter view shows left, right, X1, and X2 bus tracks, plus returns A, B and C.
664	LR, 1-12	This meter view shows left and right bus tracks as well as all 12 ISO tracks.
	LR, X1, X2, RTNs	This meter view shows left, right, X1, and X2 bus tracks, plus returns A, B and C.
	LR, 1-6	This meter view shows left and right bus tracks as well as ISO tracks 1-6.
633	LR, X1, X2, 1-6	This meter view shows left, right, X1, and X2 bus tracks as well as all 6 ISO tracks.
	LR, 1-6	This meter view shows left and right bus tracks as well as all 6 ISO tracks.
	LR, X1-X4, RTN	This meter view shows left, right, X1, and X2 bus tracks, plus X3 - X4 output signals, and return.

Editing Track Names

On the iPad, in the Transport view, track names appear superimposed over the meters near the meter labels, and these names may be edited directly from this view.

- ① *Due to smaller screen limitations, iPhones and iPod Touch devices do not show track names in the Transport view. Editing of track names is achieved from the Track view on the iPhone or iPod Touch. See [Track View on iPhone or iPod Touch](#) for more information.*

To edit track names:

1. Tap anywhere on the meter for the track you want to edit.
2. Use the virtual on-screen keyboard to modify the track name.
3. Tap Done when finished to save the changes.

- ① *Tap anywhere on screen other than the keyboard to exit without saving changes.*

Arming/Disarming Tracks

The color of the meter label changes based on whether a track is armed (red) or disarmed (gray), which may be done via Wingman. If the input is turned off, however, the background color of the label is black.

- ① *Turning an input on or off cannot be done via Wingman; it must be done on the mixer itself.*

To arm/disarm a track:

- ▶ Tap the meter label. When armed the label turns red. When on but disarmed, the label is gray, as shown for inputs 9 and 10 in the example shown below.

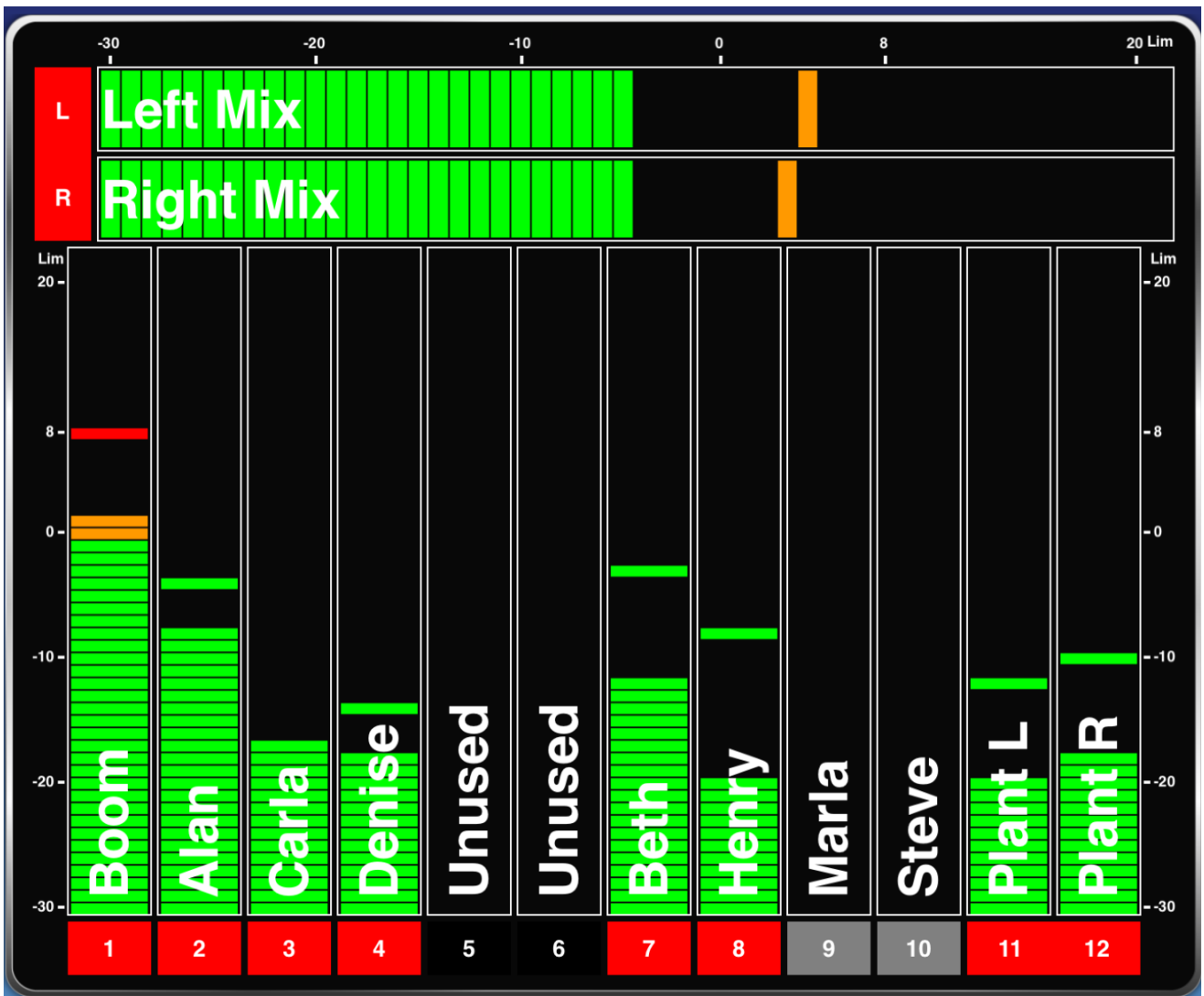



- ① *Meter labels are joined (displayed as a single label) to indicate when inputs or tracks are linked. This is shown in the example; see the meter labels for the left and right buses as well as inputs 11 and 12.*

Take List View

The Take List displays the next take, the current take, and up to 50 previous takes as a list of filenames and start timecode values. If applicable, notes and circled status are also displayed.



Whether a take is circled will be indicated in the list with a large @ symbol, while the next and current takes are always at the top of the list and identified by unique icons.

TYPE	ICON	DESCRIPTION
Next		Designates the next take, which is always located at the top of the Take List.
Current		Designates the current take. The current take is the take in the process of being recorded or, if recording has stopped, it is the last recorded take.

To view a take's file information:

1. Tap the Take List icon.
2. Tap a take in the Take List. The Info screen for the chosen take appears on the right side for iPad, or full-screen on smaller iOS mobile devices.

Editing a Take's Metadata

Editing the filename, scene name, or take number of the current or next takes will affect all subsequent takes. Editing these fields on any previously recorded take affects that file only.

- ① *Take filenames are generated dynamically from the scene name and take number; therefore, they cannot be modified directly. Editing the scene name and/or take number will automatically change a take's filename.*

Editing metadata for any take may be accomplished from the Take List view.

Circling takes, designating false takes, and editing scene, take number or notes for current and next takes may be done from the Transport view's Metadata section (shown below - on iPad only). Fields are grayed out when disabled for editing, such as the Scene and Take fields while recording is in progress.



The screenshot shows the Wingman Metadata section with two columns: CURRENT and NEXT. The CURRENT column has three input fields: SCENE (400B), TAKE (04), and NOTES (sirens.). The NEXT column has three input fields: SCENE (400B), TAKE (05), and NOTES (empty). The Wingman logo is centered between the columns.

To edit current or next take metadata:

1. Do either of the following:
 - ▶ From the Transport view, tap a field in the Take section and use the virtual keyboard to edit the data.
 - ▶ From the Take List view, tap the next or current take to open the take's Info screen, and then tap a field to use the virtual keyboard and edit the data.

Reports View

All 6-Series mixers generate sound reports as comma separated values (CSV) files. These files, stored on CompactFlash or SD cards inserted into the mixer, may be opened and edited by many common spreadsheet applications.

iPad 2:56 PM 92%

Create Report

SOUND REPORT OPTIONS

Target Media: CF

Email:

Email To: support@sounddevices.com

SOUND REPORT INFO

Project: Wingman

Producer: Jon Doe

Director: Alan Smithee

Job: None

Date: System Date

Location: Wisconsin

Sound Mixer: John Q. Public

Phone: +1(800)505-0625

E-Mail: john_public@sounddevices.com

Client: Ordinary People

Boom Op: Joe Bloggs

Prod.Co: Sound Devices

Prod.Co Tel: +1(608)524-0625

Mics: None

Comments: Best job of my career!

Transport Take List Reports About

From the Reports view in Wingman, you can modify sound report options, define the headers used in sound reports, and create sound reports.

- ① *Settings in the mixer's File Storage > Folder Options determine which files are used to generate the report and the current record directory in which the generated report is saved.*

To modify sound report options:

1. Tap the Reports icon.
2. In the Sound Report Options section, set Target Media. Options include: CF or SD. This option determines the media in the mixer on which a sound report is stored. The default is CF.
3. Set both email preferences accordingly.

OPTION	DESCRIPTION
Email:	Turns email on or off. If turned on, then after a sound report is created, the mobile device's email application opens with the CSV file automatically attached to a new email. When turned off, any sound report created is stored on the mixer, but not sent as an email attachment on the mobile device.
Email To:	The address entered here is automatically applied to the To field in the mobile device's email application when it is opened after creating a sound report.

To define headers for sound reports:

1. Tap the Reports icon.
2. In the Sound Report Info section, select a header to edit from the list. Headers include such options as: Project, Producer, Director, Location, Client, etc.
- ① *Some headers provide pre-configured options. For instance, Roll may be set to None or Mid-Level Folder. Likewise, Date provides three options: None, System, or User. When set to System, the mixer's system date is used in the sound report. When set to User, the sound report will use the date set by the user in the app.*
3. When necessary, use the virtual keyboard that appears to enter data.
4. Tap Done.
5. Repeat steps 2-4 as needed.

When editing a sound report header on the mixer directly, new entries may be added so that a list of options for a header is created. This is not the case when editing headers from Wingman. New entries are not created; rather the current selection for the chosen header on the mixer is modified. If a field is saved with no entry, the <None> option is used.

Creating Sound Reports

Sound reports created from Wingman are stored on the mixer and may be emailed from your iOS device.

To create a sound report:

1. Tap the Reports icon.
2. Tap the Create Report button at the top of the screen.
 - If the Email option is turned on, the sound report (csv) file will appear as an attachment to an email that opens on screen.
 - If the Email option is turned off, a message appears indicating the successful creation of the sound report, which is stored in the current directory on the target media (CF or SD) inserted into the mixer.

① *Report creation is not allowed during recording.*

About View

The About view displays important information and links related to the Wingman application and the 6-Series mixer to which it is connected.

Information available in the About view includes:

- Wingman application version number
- Build number
- WM-Connect version number
- 6-Series model number
- 6-Series firmware version number

Also included are interactive links to the following online resources:

- The WM-Connect Quick Start Guide
- The Wingman User Guide
- The connected 6-Series mixer's User Guide
- Link to file a Support Query with Sound Devices Technical Support

Track View on iPhone or iPod Touch

Because iPhone and iPod Touch mobile devices have smaller screens, the Wingman's user interface appears slightly different from the application when run on an iPad. The main differences lie with the Transport view, which on smaller screens does not display track names or the Metadata section.

For this reason, editing metadata for current and next takes must be done from the Take List view. Also, because the size of the meters are reduced in the Transport view on smaller iOS devices, editing and arming of tracks is accomplished via a separate Track view instead of from the Transport view.

To toggle between Transport and Track views:

- Swipe a fingertip horizontally across the screen.

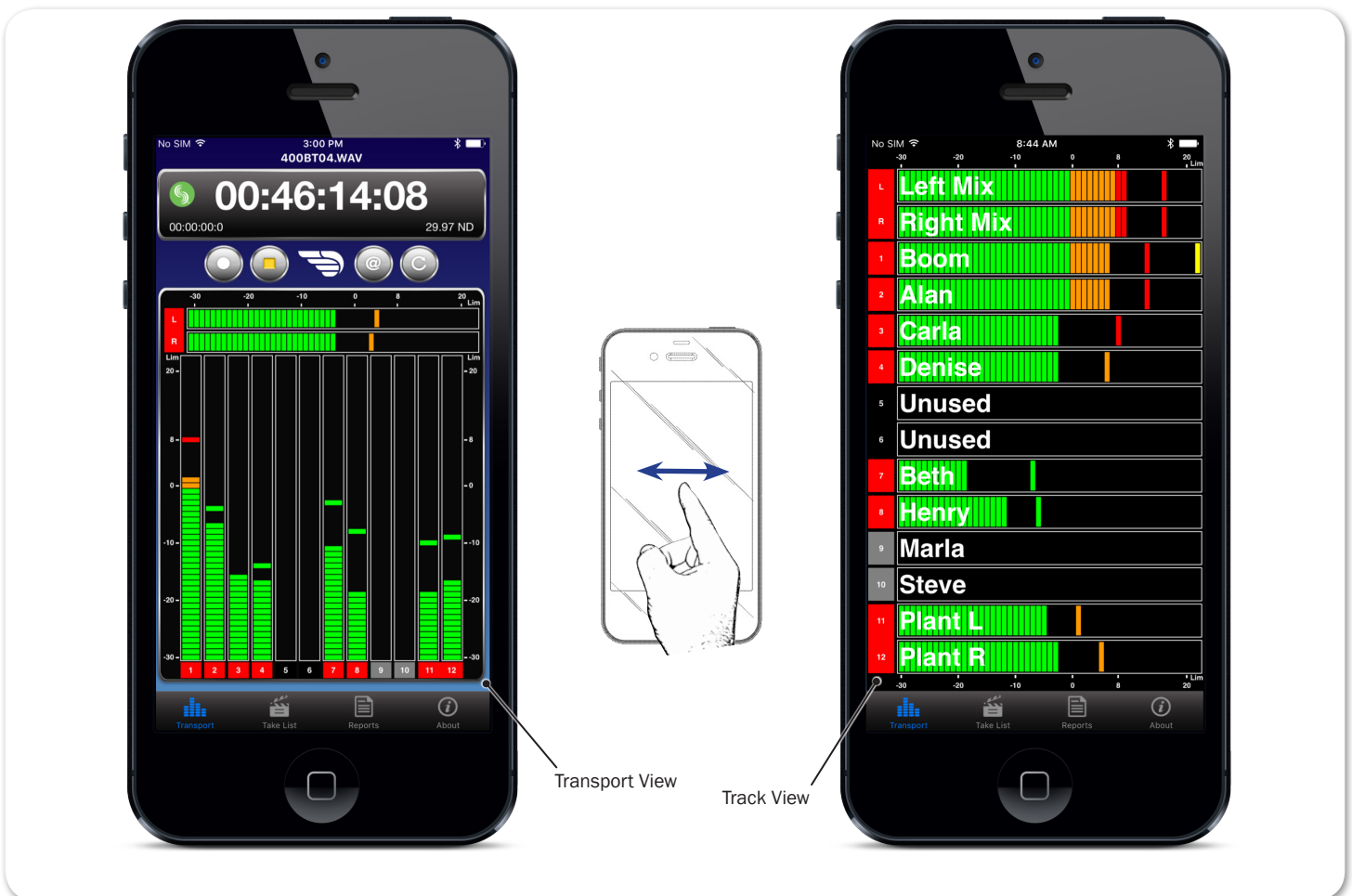

In the Track view, the Timecode display and toolbar with transport buttons disappear, and the meters are displayed horizontally full-screen, with track names superimposed over the meters.

To edit track names:

1. While viewing Transport, swipe right or left to display the Track view.
2. Tap anywhere on the horizontal meter for the track you want to edit.

3. Use the virtual on-screen keyboard to modify the track name.
 4. Tap Done when finished to save the changes.
- ① *Tap anywhere on screen other than the keyboard to exit without saving changes.*

To arm/disarm a track:

1. While viewing Transport, swipe left or right to display the Track view.
 2. Tap the meter label, located left of the meter for the track you want to arm or disarm. The background color will change accordingly. When armed the label turns red. When on but disarmed, the label is gray.
- ① *When input is off, the label appears black, and the input cannot be armed.*

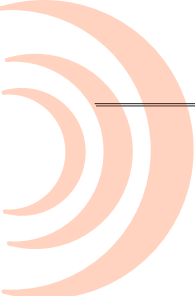

Through collaboration with third-party companies— Ambient Recording, Lockit Network GmbH, PureBlend Software and Timecode Systems—Sound Devices offers wireless remote control of any 6-Series mixer (688, 664, and 633) via iOS and web-based mobile devices.

This section outlines the benefits and what is required for iOS and web-based wireless remote control integration. Please refer to your third-party manufacturer's documentation for more details on setup and basic user information.

Topics in this section include:

- ▶ Control in the Palm of Your Hand
- ▶ iOS Wireless Remote Control
- ▶ Web-based Wireless Remote Control

Control in the Palm of Your Hand

The ability to remotely control any 6-Series mixer/recorder with easy, wireless operation and larger touchscreen GUIs adds untethered freedom and flexibility on set and in the field. With wireless remote control, via iOS or web-based devices, Sound Mixers can:



- Edit scene names, takes, and notes
- Start and stop recording
- Arm tracks and edit track names
- Circle takes
- Set false takes
- Create sound reports

① *Although these third-party wireless systems do not initiate sound reports on the actual mixers, they can create sound reports from their own applications' databases. For more information regarding sound report creation on the mixer itself, see "Generating Sound Reports" in the File Storage chapter of this User Guide.*

iOS Wireless Remote Control

All 6-Series mixers support wireless remote control from iOS mobile devices, such as iPhone, iPad, or iPod Touch.

This integration does require the following third-party hardware and software:

HARDWARE / SOFTWARE	DESCRIPTION
	<p>The :wave by Timecode Systems is a highly accurate timecode and genlock generator with integrated RF transceiver and WiFi.</p> <p>Firmware v3.38 or later required.</p> <p>For timecode connection, connect the :wave TC to the mixer's TC via 5-pin Lemo cable (not shown).</p>
	<p>For remote control, use the TCB-40—a 9-pin Lemo® to USB-B cable available from Timecode Systems—to connect the DATA port on the :wave to the 6-Series mixer's USB port.</p>
	<p>When connecting to the CL-12 instead of the mixer, either use the TCB-41—a 9-pin Lemo to USB-A cable (shown) that is available from Timecode Systems—or a USB-B (female) to USB-A (male) adapter.</p>
<p>MovieSlate</p>	<p>From the App Store, download and install the MovieSlate app by PureBlend Software.</p> <p>MovieSlate® v8.5 or later is required, which runs on devices with iOS 8,9 or 10.</p> <p>Also required is the Sound Department PRO, an optional plug-in that is part of the MovieSlate 8 Pro Features available for purchase from within the app or as a monthly subscription.</p>

- ① *Refer to Timecode Systems documentation for how to set up the :wave, and PureBlend Software documentation for details on how to use the MovieSlate app and its Sound Department PRO plug-in.*

iOS Remote Control Connection Diagrams

The following diagram shows a direct-to-mixer connection.



The following diagram shows a direct-to-CL-12 connection.



① The CL-12 linear fader controller is an optional accessory for the 6-Series. See the CL-12 Quick Start Guide for information on connecting a CL-12 to a mixer.

iOS Remote Control Examples

Here is an example of what the app looks like on an iPhone:

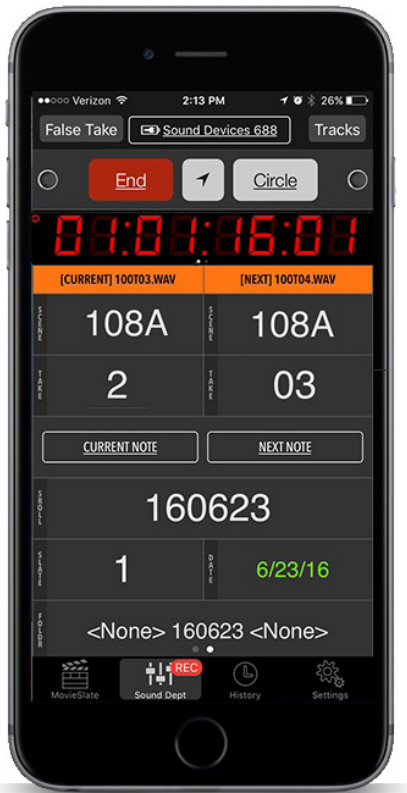



Here is an example of what the app looks like on an iPad:



Web-based Wireless Remote Control

All 6-Series mixers support web-based wireless remote control via PC or Mac computers and mobile devices, such as Android or iOS smart phones or tablets, that have a web interface.

This integration does require the following third-party hardware and software:

HARDWARE / SOFTWARE	DESCRIPTION
 <p>ACN-ML Master Lockit</p>	<p>The Master Lockit by Ambient® Recording is the control center of the ACN timecode and metadata network. Acting as the network central hub, it enables remote control of all ACN units on set via browser on any WiFi capable device. In addition, it collects all metadata from script, continuity, and professional cameras for delivery and use by DITs and post production.</p> <p>Firmware v4.10 or later required.</p> <p>For timecode connection, connect the Master Lockit TC to the mixer's TC via 5-pin Lemo cable (not shown).</p>
	<p>Using the MLC-HID—a 5-pin Lemo to USB-A cable, available from Ambient—connect the ACN-ML Master Lockit to the mixer's USB port (or to a CL-12's USB keyboard port).</p>
	<p>When connecting directly to the mixer instead of to the CL-12, a USB A (female) to B (male) adapter is also necessary.</p>
<p>Web Browser</p>	<p>Ensure that your computer or mobile device has a web browser and WiFi.</p>

- ① *Refer to Ambient Recording documentation for more information on how to set up the ACN-ML Master Lockit and use its web-based feature for controlling the mixer.*

Web-based Remote Control Connection Diagrams

The following diagram shows a direct-to-mixer connection.



The following diagram shows a direct-to-CL-12 connection.



Web-based Remote Control Examples

Here is an example of what the web interface looks like on a smart phone:

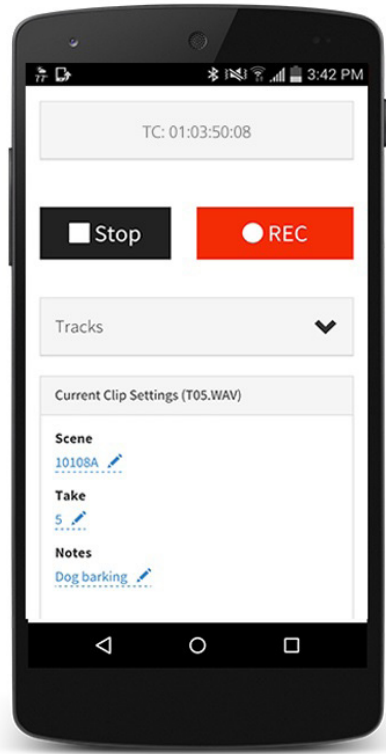

Here is an example of what the web interface looks like on a PC:

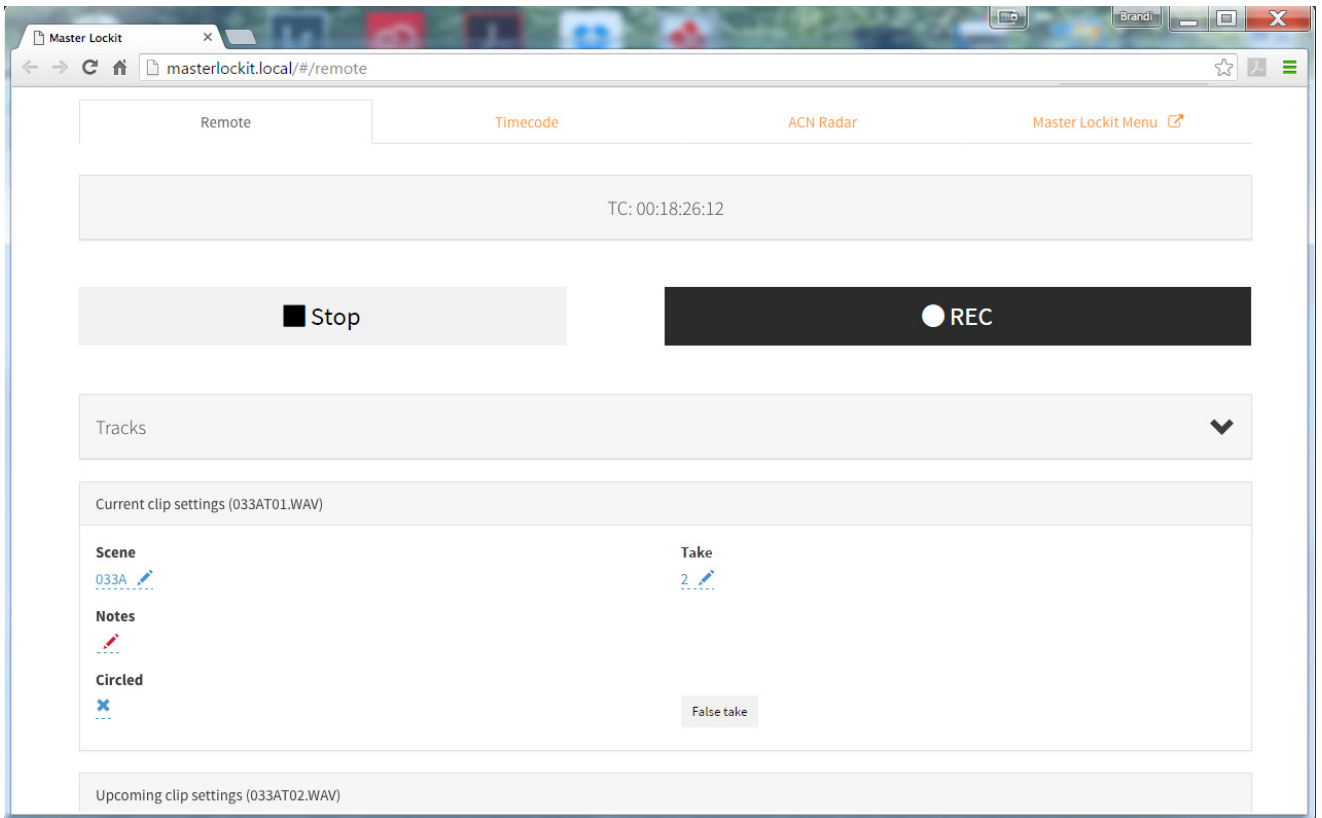

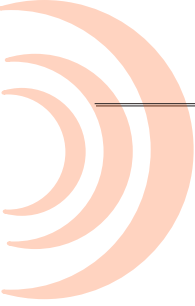

Various product specifications for the 633 are provided here for your convenience. They relate to inputs and outputs, powering, environmental parameters, as well as physical aspects of the mixer.

Specifications are subject to change without prior notice.

For the latest information available on all Sound Devices products, visit our website at: www.sounddevices.com.

Topics in this section include:

- ▶ Analog Inputs
- ▶ Digital Inputs
- ▶ Analog Outputs
- ▶ Digital Outputs/Recorder
- ▶ Timecode and Sync
- ▶ Power
- ▶ Environmental
- ▶ Dimensions and Weight

Analog Inputs

NAME	DESCRIPTION
Frequency Response	· 10 Hz to 40 kHz \pm 0.5 dB, -3dB @ 65 kHz (192 kHz sample rate, re 1 kHz)
THD + Noise	· 0.09% max (1 kHz, 22 Hz–22 kHz BW, fader at 0, 0 dBu output)
Equivalent Input Noise	· -126 dBu (-128 dBV) maximum. (22 Hz - 22 kHz bandwidth, flat filter, trim control fully up)
Inputs	· XLR-3F Mic: Active-balanced for use with \leq 600 ohm mics · XLR-3F Line: Active-balanced for use with \leq 2k ohm outputs · RTN (3.5 mm): Unbalanced stereo for use with \leq 2k ohm outputs
Input Clipping Level	· 0 dBu minimum (trim control fully down)
Maximum Input Level	· XLR-3F Mic: 0 dBu (0.78 Vrms) · XLR-3F Line: +40 dBu (80 Vrms) · RTN (3.5 mm): +24 dBu (12.4 Vrms)
Pre-Fader Input Limiters (Inputs 1-3)	· +16 dBu threshold (fixed) · 20:1 limiting ratio · 1 mS attack time · 500 mS release time
Post-Fader Input Limiters (Inputs 1-6)	· Adjustable threshold +4 dBu to +18 dBu · 20:1 limiting ratio · 1 mS attack time · 500 mS release time

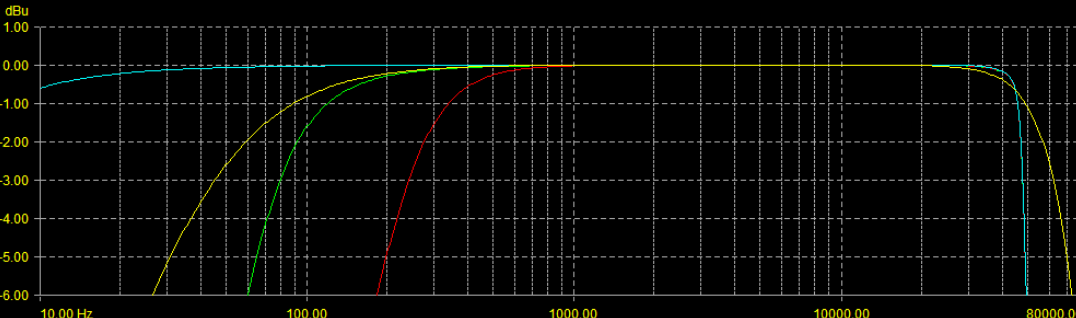
<p>High-Pass Filters</p>	<p>Sweepable 80 Hz to 240 Hz, 12 dB/oct at 80 Hz, 6 dB/octave at 240 Hz</p>  <ul style="list-style-type: none"> · Blue: 96 K full response · Green: 96 K 80 Hz · Yellow: 50 hz 192 K · Red: 96 K 240 Hz
<p>Microphone Powering (each analog Input selectable)</p>	<ul style="list-style-type: none"> · 12 V Phantom: through 680 ohm resistors, 10 mA per mic available · 48 V Phantom: through 6.8 k resistors, 10 mA per mic available

Digital Inputs

NAME	DESCRIPTION
AES3	<ul style="list-style-type: none"> · Balanced: 110 ohm
AES42	<ul style="list-style-type: none"> · AES42 Mode 1, provides +10 V Digital Phantom Power
Post-Fader Digital Limiters	<ul style="list-style-type: none"> · Adjustable threshold +4 dBu to +18 dBu · 20:1 limiting ratio · 1 mS attack time · 500 mS release time

Analog Outputs

NAME	DESCRIPTION
Output Type	<ul style="list-style-type: none"> · Line (XLR-3M): active balanced for use with ≥ 120 ohm inputs · -10 (XLR-3M): active balanced for use with $\geq 10k$ ohm inputs · Mic (XLR-3M): active balanced for use with ≥ 600 ohm inputs · TA3 Mic/Line: active balanced, pin-2 and 3 driven, for use with $\geq 3k$ ohm inputs · X3, X4 (3.5 mm): unbalanced, stereo, for use with $\geq 6k$ ohm inputs · Headphones (1/4"): unbalanced, stereo, for use with 8-2k ohm headphones
Output Impedance (ohms actual)	<ul style="list-style-type: none"> · XLR-3M & TA3 balanced outputs: 100 ohms @ LINE, 3.2k ohms @ -10, 150 ohms @ MIC · TA3 Mic/Line: 1k ohms · X3, X4 (3.5 mm): 100 ohms · Headphones (1/4"): 100 ohms
Maximum Gain	<ul style="list-style-type: none"> · Master Outs (XLR-3M) @ LINE: 91 dB MIC Level Input; 51 dB LINE Level Input · Master Outs (XLR-3M) @ -10: 77 dB MIC Level Input; 37 dB LINE Level Input · Master Outs (XLR-3M) @ MIC: 51 dB MIC Level Input; 11 dB LINE Level Input · X3/X4 Outs (3.5 mm): 77 dB MIC Level Input; 37 dB LINE Level Input · Mic-In to L/R/X1/X2/X3/X4 (Mic): 51 dB
Headphone Max. Gain	<ul style="list-style-type: none"> · 107 dB (Mic Input) · 67 dB (Line Input) · 5 dB (RTN)
Line Output Clipping Level (1% THD)	<ul style="list-style-type: none"> · 20 dBu minimum with 10k load

Output Limiters	<ul style="list-style-type: none"> · L/R and X1/X2, adjustable threshold from +4 dBu to +18 dBu, 1 dB steps · 20:1 limiting ratio · 1 mS attack time · 500 mS release time
-----------------	--

Digital Outputs/Recorder

NAME	DESCRIPTION
AES3 Output:	<ul style="list-style-type: none"> · AES Out A,B on XLR-3M connectors · 110 ohm, 2 V p-p, AES and S/PDIF compatible with RCA adapter
Sampling Frequency	<ul style="list-style-type: none"> · 44.1 kHz · 47.952 kHz · 48 kHz · 48.048 kHz · 88.2 kHz · 96 kHz · 192 kHz
A/D	<ul style="list-style-type: none"> · 24 bit
A/D Dynamic Range	<ul style="list-style-type: none"> · 114 dB, A-weighted, typical
Input Delay	<ul style="list-style-type: none"> · Adjustable 0-30 mS for each input in 0.1 mS steps
Output Delay	<ul style="list-style-type: none"> · Adjustable 0-10 frames for each output in 0.1 frame steps
Media Type	<ul style="list-style-type: none"> · Secure Digital Extended Capacity (SDXC) · Secure Digital High Capacity (SDHC) · Secure Digital (SD) · CompactFlash (CF) · FAT32 formatted (<32GB), exFAT for (>32GB), on-board memory card formatting
File Type	<ul style="list-style-type: none"> · Record: WAV (Broadcast Wave File format), polyphonic or MP3 · Playback: WAV (Broadcast Wave File format), polyphonic or MP3
Sampling Clock Accuracy	<ul style="list-style-type: none"> · ± 0.2 ppm

Timecode and Sync

NAME	DESCRIPTION
Modes Supported	<ul style="list-style-type: none"> · Off · Rec Run · Free Run · 24h Run · External
Frame Rates	<ul style="list-style-type: none"> · 23.976 · 24 · 25 · 29.97DF · 29.97ND · 30DF · 30ND
Accuracy	<ul style="list-style-type: none"> · Ambient Generator: ± 0.2ppm (0.5 frames per 24 hours) · Holds TC clock for two hours after main battery removal
Timecode Input	<ul style="list-style-type: none"> · 20k ohm impedance · 0.3 V - 3.0 V p-p (-17 dBu - +3 dBu)
Timecode Output	<ul style="list-style-type: none"> · Output: 1k ohm impedance · 3.0 V p-p (+12 dBu)

Power

NAME	DESCRIPTION
External Power Supply	<ul style="list-style-type: none"> 10-18 V on locking 4-pin Hirose connector, pin-4 = (+), pin-1 = (-) Mates with gold Hirose #HR10A-7P-4P (DigiKey# HR110-ND) or silver Hirose #HR10-7P-4P (DigiKey# HR100-ND) locking connector
Internal Power Supply	<ul style="list-style-type: none"> 5-10 V range Accepts 6 AA-sized (LR6) batteries (NiMH rechargeable recommended) <p><i>ⓘ There are similar sized 3+ V Lithium cells that are not compatible.</i></p>
PowerSafe	<ul style="list-style-type: none"> 10 second power reserve
Idle Current Draw	<ul style="list-style-type: none"> 447 mA at 12 V (5.36W) - Inputs 1-6 powered on, SD and CF inserted

Environmental

NAME	DESCRIPTION
Operation and Storage	<ul style="list-style-type: none"> Operating: -20° C to 60° C Storage: -40° C to 85° C 0 to 90% relative humidity (non-condensing)

Dimensions and Weight

NAME	DESCRIPTION
Size (H x W x D)	<ul style="list-style-type: none"> 2.2 in x 9.4 in x 5.6 in 5.6 cm x 23.8 cm x 14.3 cm
Weight	<ul style="list-style-type: none"> 2 lbs 9.4 oz (unpackaged, without batteries) 1.00 kg (unpackaged, without batteries)

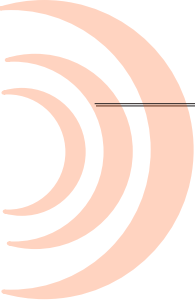

The 633 works with various accessories which may be purchased separately and used to further enhance your field mixing and recording experience.

This section is not intended to be an all-inclusive list of accessories available for use with the 633.

For the latest information available on all Sound Devices products and their accessories, visit our website at:

www.sounddevices.com







Topics in this section include:

- ▶ Electronic Accessories
- ▶ Cables and Connectors
- ▶ Cases
- ▶ Software

Electronic Accessories



ACCESSORY	PHOTO	DESCRIPTION
CL-12		<p>This optional linear fader controller comes in two models and provides smooth-gliding 100 mm linear faders, LED metering, and numerous, illuminated dedicated buttons for quick-access to key functionality.</p> <p>The CL-12 Alaia has the same features as the standard model, plus custom wood side panels and Penny & Giles faders for an enhanced mixing experience.</p> <p>For more information, see <i>CL-12 Linear Fader Controller</i>.</p>

Cables and Connectors

ACCESSORY	PHOTO	DESCRIPTION
XL-2		A 25-inch TA3-F to XLR-3M cable, used to connect the TA3 auxiliary outputs to third-party devices with XLR-3F inputs. Each package contains two cables.
XL-2F		A 25-inch XLR-3F to TA3-F cable, used to connect mixers and other devices with XLR-3M outputs to the TA3 7-12 inputs on the 633. Also used to attach standard microphone as auxiliary slate mic. Each package contains two cables.
XL-3		A 12-inch, 3.5mm to TA3F link cable.
XL-4		Bag of four (4) TA3-F-type connectors.
XL-H		Bare Hirose 4-pin locking DC connector (HR10-7P-4P).
XL-NPH		An NP-type battery cup with 24-inch cable terminated in Hirose 4-pin locking DC connector (HR10-7P-4P).

ACCESSORY	PHOTO	DESCRIPTION
XL-LL		LEMO-5 to LEMO-5 coiled cable for timecode interconnection between the 633 and other devices.
XL-LX		LEMO-5 to XLR-3F input and XLR-3M output for timecode interconnection between the 633 and other devices.
XL-WPH3		The XL-WPH3 is an AC-to-DC (in-line) 100-240V power supply unit with 50/60 Hz input, a 12 VDC 3.75 A (45 W) output, and a Hirose 4-pin DC plug. It comes supplied with a 3-pin IEC cord.

Cases

ACCESSORY	PHOTO	DESCRIPTION
CS-633		Manufactured by PortaBrace for Sound Devices, this production case was designed for use with the 633 Compact Field Production Mixer. Front pocket provides space for wireless receivers and/or NP-1 battery. The bottom panel opens and expands to provide access to rear-mounted L-Series batteries.
CS-Strap		This medium-duty neck strap with metal hooks was designed by PortaBrace for use with various Sound Devices production cases.

Software

ACCESSORY	PHOTO	DESCRIPTION
Wave Agent		<p>Sound Devices Wave Agent, a file librarian for computers, provides a comprehensive range of tools for preparing audio files for problem-free passage through complex production workflows.</p> <p>For more a free download, visit: www.waveagent.com</p>

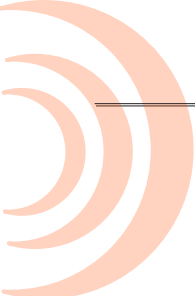

The CL-12 linear fader controller, which comes in two models, is an optional accessory that significantly expands the mixing capability of the 6-Series mixer/recorder line.

The standard CL-12 adds 12 linear faders, numerous fast-access buttons, and enhanced, daylight viewable LED metering.

The CL-12 Alaia™ has the same impressive feature-set the standard CL-12 offers, but also includes pro-quality, smooth gliding Penny & Giles faders as well as custom hardwood side panels in two finishes.

The CL-12 Alaia™ also ships with an Aluminum Endcap Kit. For more details, see [Replacing Side Panels](#).

Topics in this section include:

- ▶ Connecting CL-12 to 6-Series Mixer
- ▶ Overview of Panels
- ▶ Altered Functionality
- ▶ Selecting One or More Input Channels
- ▶ Activating PFL of an Input
- ▶ Trim Level Adjustment on 6-Series
- ▶ Routing Input Channels
- ▶ Adjusting Output or Track Levels
- ▶ Disabling Output Controls
- ▶ Arming L, R, X1, X2 Tracks
- ▶ Using the 3-Band Equalizer (688 only)
- ▶ Using High-pass Filters
- ▶ Naming Tracks
- ▶ Configuring User Programmable Buttons
- ▶ Adjusting CL-12's LED Brightness
- ▶ Replacing Side Panels
- ▶ Specifications

Connecting CL-12 to 6-Series Mixer

It connects via a USB cable, which provides both power and control of the CL-12, plus a ¼-inch headphone cable to provide both a ground connection to the chassis as well as monitoring from the CL-12. Additional power via a micro USB cable is required when connecting the CL-12 to a 664 or 633. This additional power source is optional when attaching the CL-12 with a 688, but recommended when power-hungry USB peripherals are used, such as higher-power USB keyboards or lights.

CAUTION: To avoid sudden level changes, it is recommended that all rotary faders on the mixer and linear faders on the CL-12 be set to -infinity before connecting or disconnecting the the CL-12 accessory. When the CL-12 is connected, fader levels are determined by the linear faders; when disconnected, levels are set by the mixer's rotary faders.

To connect the CL-12 to the mixer:

1. Connect one end of a micro USB power cord to the DC Boost Input on the CL-12's back panel and the other end to an external power source.

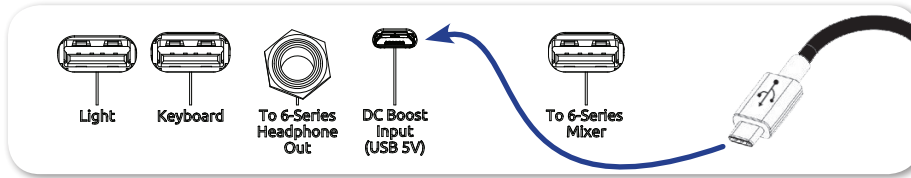

When extra power is connected via DC Boost Input, illumination of the LEDs and backlit buttons on the CL-12 will be brighter.

- Using the TRS headphone cable provided with the CL-12, connect the mixer's 1/4-inch unbalanced stereo headphone output to the CL-12's 1/4-inch headphone input on its back panel.

As well as providing a solid low-noise path for the headphone signal, the supplied 1/4-inch TRS cable also adds a low-resistance ground connection to the CL-12 chassis. This additional connection gives extra robustness to the mixer/CL-12 in the presence of static shocks to the CL-12 chassis.

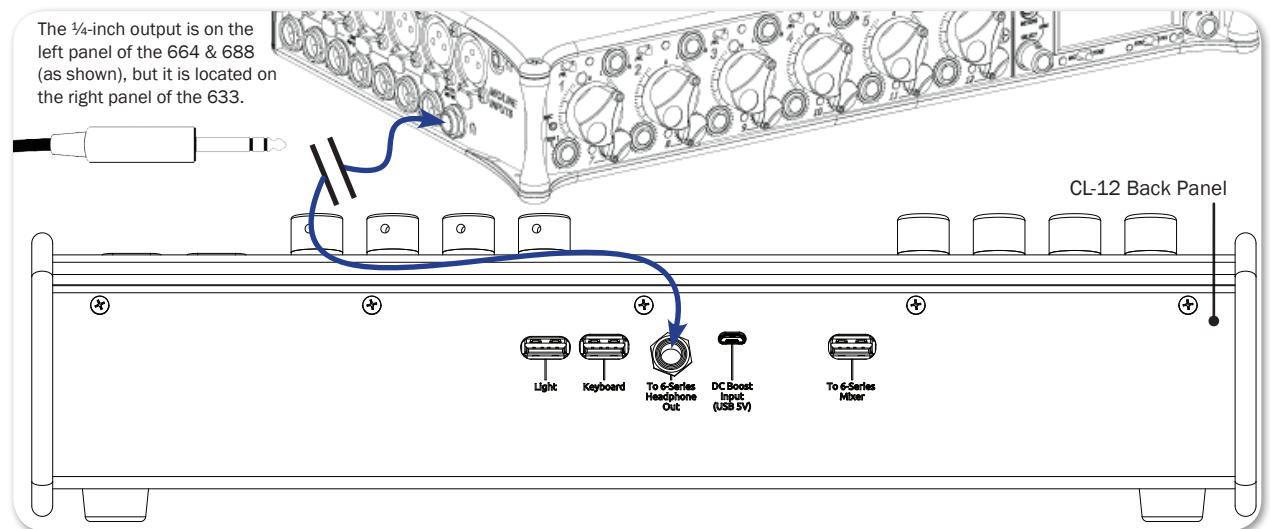

- Using a standard USB A-to-B cable, insert the B connector into the mixer's USB port on the right side panel.

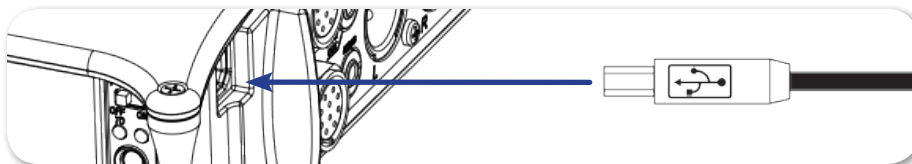

- Insert the A connector into the USB port, labeled To 6-Series Mixer, on the back panel of the CL-12.

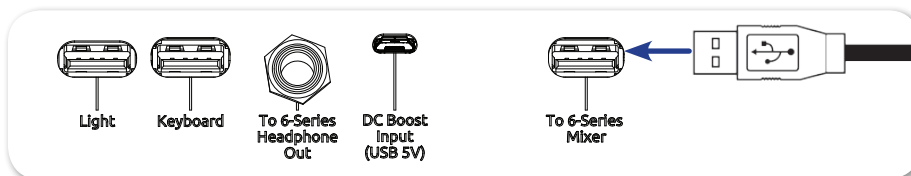

- ① *The other USB ports on the back of the CL-12, and labeled respectively as Light and Keyboard, may be used to attach an external USB light, and a keyboard for easier metadata entry.*

5. Plug headphones into either HP port— $\frac{1}{4}$ -inch or $\frac{1}{8}$ -inch (3.5 mm)—on the front panel of the CL-12.

Overview of Panels

The front and back panels of the CL-12 provide a number of connection ports for a variety of purposes. The front panel has two headphone outputs, a $\frac{1}{4}$ -inch and a 3.5 mm TRS jack.

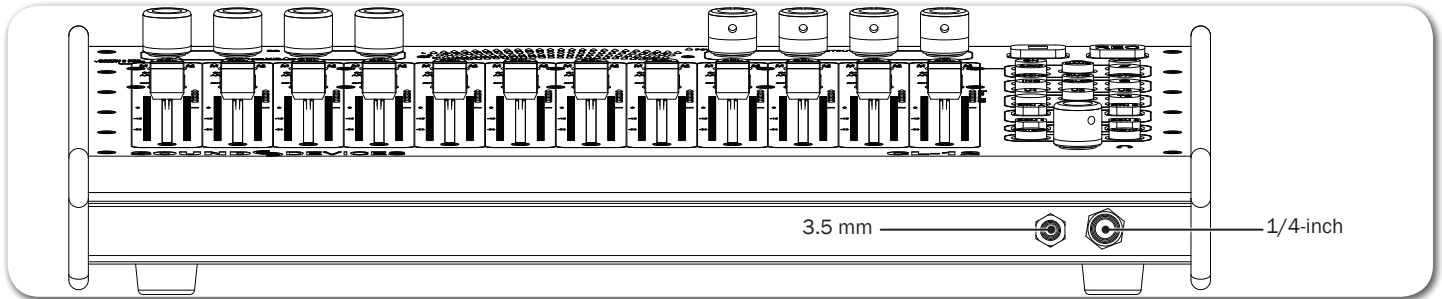

The back panel provides the connections required for attaching the CL-12 to 6-Series mixers, plus ports for other peripherals.

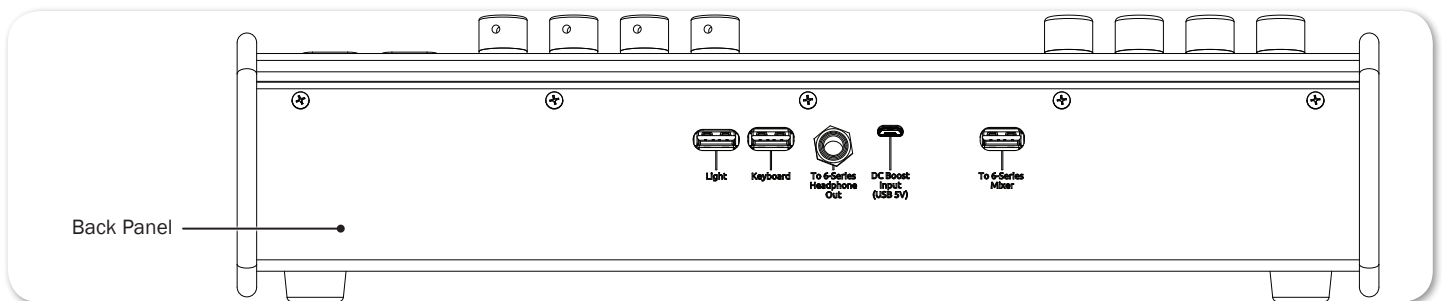

FEATURE	DESCRIPTION
Light	USB A connection for attaching an external USB light source, useful for illuminating the CL-12 surface in low light conditions.
Keyboard	USB A connection for attaching a peripheral USB keyboard, which can be used for control and entering metadata. This port may also be used to connect third-party systems for wireless remote control of 6-Series mixers. ⓘ <i>When using an external keyboard, first ensure MENU > System > USB Port is set to USB Host/Keyboard before plugging in the keyboard.</i>
Headphone Input	A $\frac{1}{4}$ -inch headphone jack for connecting the CL-12 to the mixer's $\frac{1}{4}$ -inch headphone output, making it possible to monitor audio directly from the front of the CL-12. Use the supplied $\frac{1}{4}$ -inch to $\frac{1}{4}$ -inch cable, which adds a low-resistance ground connection to the CL-12 chassis for extra robustness between the mixer and the CL-12 in the event of static shock.

FEATURE	DESCRIPTION
DC Boost Input	<p>Connect a micro USB power cord (not included with the CL-12) to this port (5V) on the CL-12 is required for connecting a CL-12 to either a 664 or 633.</p> <p>When using a CL-12 with a 688, this port is optional, but recommended for providing additional DC power when necessary, such as for powering a high-current-draw USB keyboard. Connecting additional power to this port will also allow for brighter illumination of the CL-12's buttons and LEDs.</p>
To 6-Series Mixer	<p>Connect this USB port on the CL-12 to the mixer's USB B port by using the supplied USB cable. This connection provides both control and power to the CL-12.</p> <p>① <i>When the CL-12 is connected, any CL-6 attached to the mixer is disabled.</i></p>

The top panel of the CL-12 has an abundance of faders, buttons, LEDs, and controls for an intuitive mixing and control user experience.

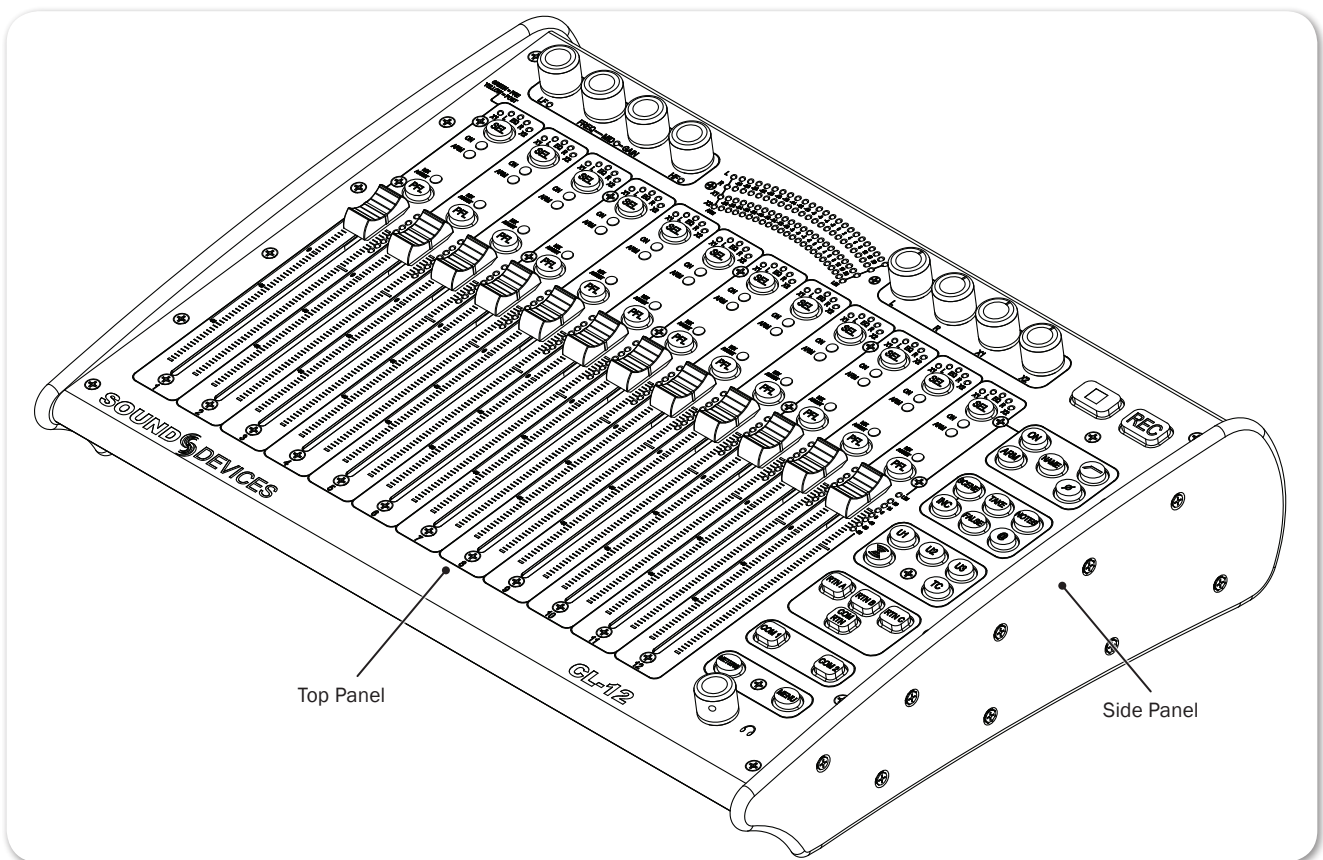

To fully explain each feature of the CL-12's top panel, the mixing surface is divided into three areas:

- Top – comprised of the EQ and OUTPUTS sections
- Left – comprised of the Channel Strip section
- Right – comprised of the Headphone encoder and several sections of buttons for various functions, such as transport control, channel selection, etc.

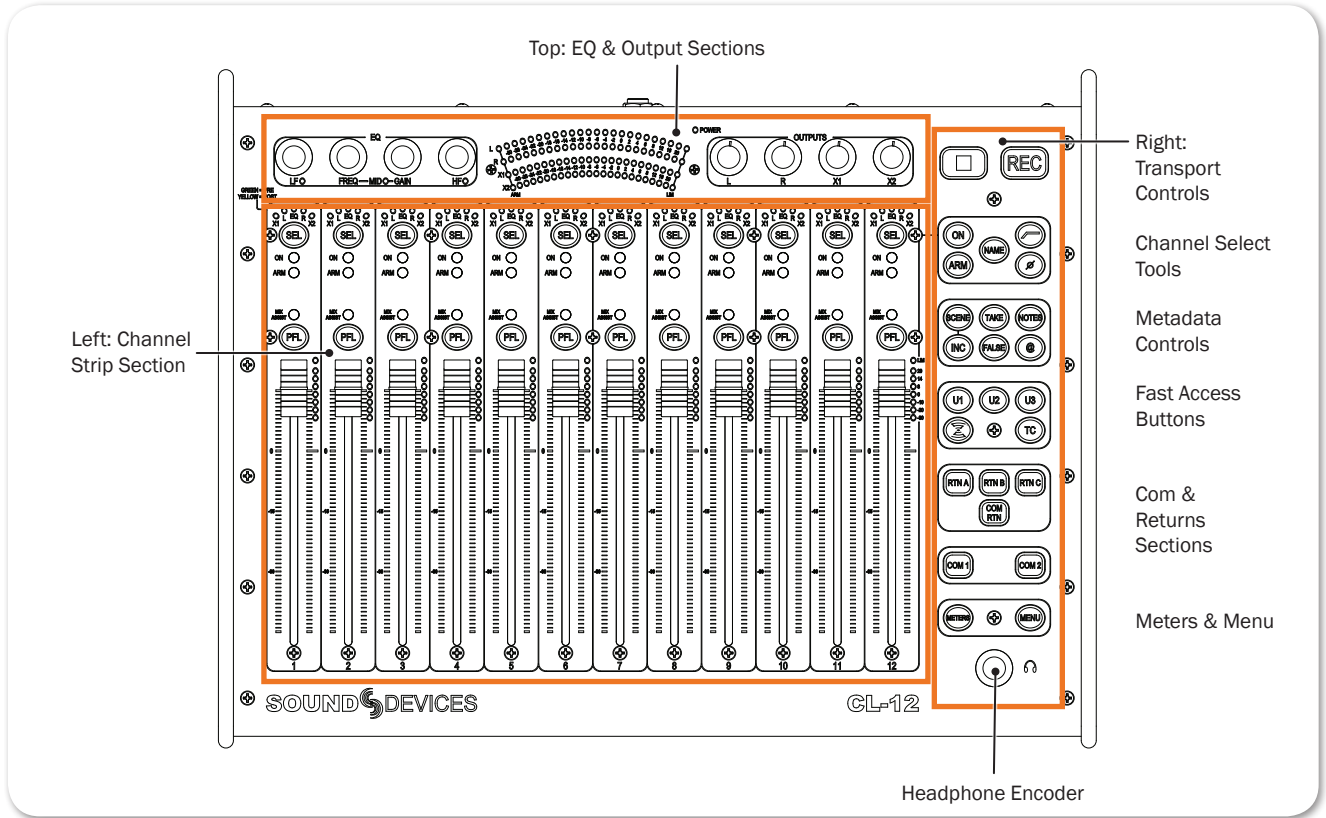

Top: EQ & OUTPUTS Sections

The area that spans the top edge of the mixing surface has rotary controls for EQ and Outputs, as well as LED metering and the Power LED.

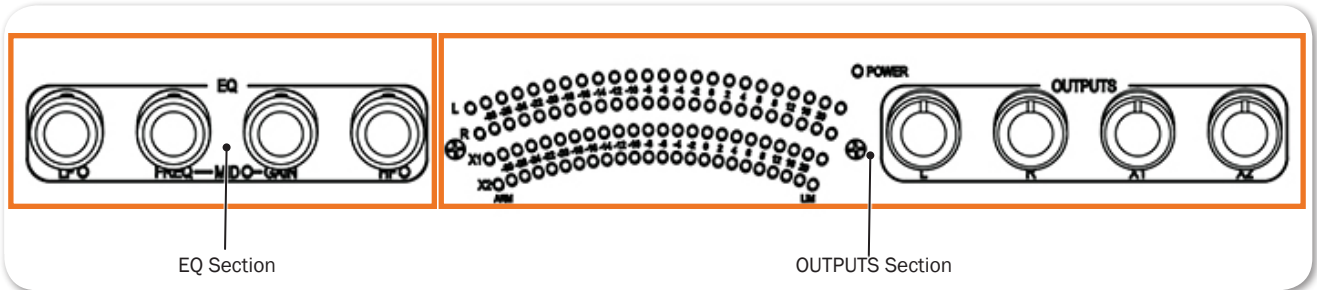

① *Not all features described here are available with every mixer. For more information, see [CL-12 Comparison Chart](#).*

FEATURE	DESCRIPTION
EQ Controls	There are four rotary encoders in the EQ section. These 3-band EQ controls include LF gain, MID frequency/gain, and HF gain. Other EQ parameters, such as Q-factor and filter type are set up from the CL-12 > EQ sub-menu. For more information, see Using the 3-Band Equalizer (688 only) , Bypassing EQ and Accessing the Submenu .

FEATURE	DESCRIPTION
LED Output Meters	Displays 22-segment metering levels, as well as both ARM and LIM (limiter) LEDs for L, R, X1, and X2. ❶ <i>LED meters may be configured to display either output or track levels.</i> For more information, see Configuring Output Meters (688 only) .
Power LED	Illuminates green when the CL-12 is powered on via the USB connection to an attached 6-Series mixer.
Output Controls	There are four rotary controls or “pots” in the OUTPUTS section, which may be used for routing as well as adjusting output or track levels. Press to route or arm; turn to adjust level. For more information, see Adjusting Output or Track Levels and Arming L, R, X1, X2 Tracks .

Left: Channel Strip Section

The area that spans the majority of the mixing surface comprises 12 channel strips. Each strip is comprised of 12 linear faders, SEL and PFL buttons, LED indicators and LED meters. The CL-12’s low latency faders allow for responsive level adjustment.

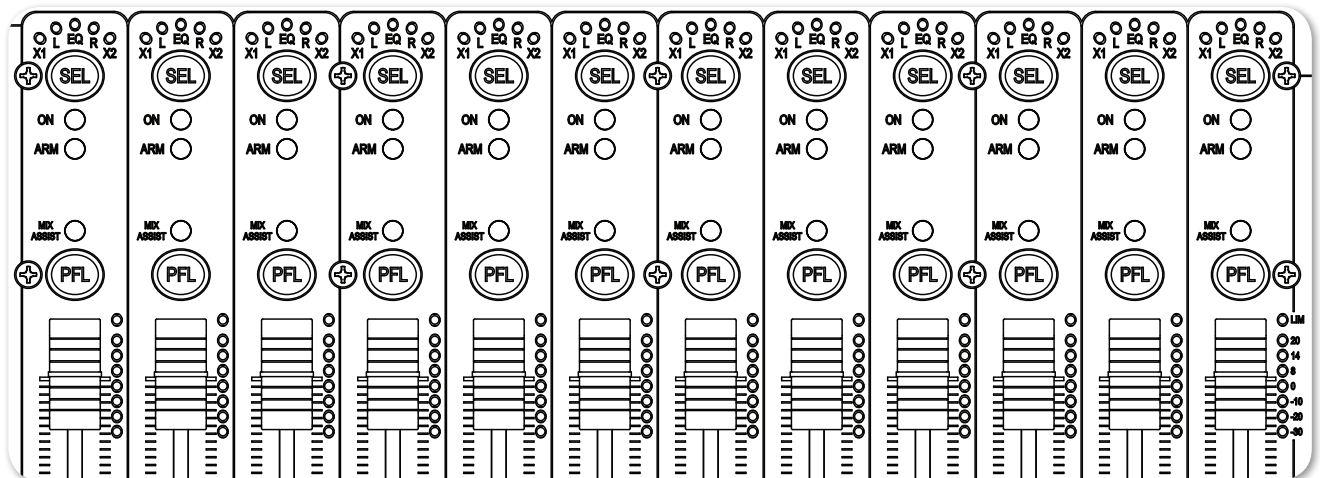

❶ *Not all features described here are available with every mixer. For more information, see [CL-12 Comparison Chart](#).*



FEATURE	DESCRIPTION
X1 Routing Indicator	Illuminates when the input channel has been routed to the X1 output. <ul style="list-style-type: none"> • Off = not routed • Green = pre-fade routing • Yellow = post-fade routing
L Routing Indicator	Illuminates when the input channel has been routed to the left bus. <ul style="list-style-type: none"> • Off = not routed • Yellow = post-fade routing
EQ LED	Indicates when some form of EQ has been applied to the input channel. Illuminates blue if any LF, MID, or HF EQ band is set to non-zero gain for the selected input.

FEATURE	DESCRIPTION
R Routing Indicator	<p>Illuminates when the input channel has been routed to the right bus.</p> <ul style="list-style-type: none"> • Off = not routed • Yellow = post-fade routing
X2 Routing Indicator	<p>Illuminates when the input channel has been routed to the X2 output.</p> <ul style="list-style-type: none"> • Off = not routed • Green = pre-fade routing • Yellow = post-fade routing
SEL Button	<p>Selects or deselects an input channel, or multiple input channels for adjustment.</p> <p>Each SEL button illuminates when a channel is selected.</p> <p>While selected, an input channel may be routed to L, R, X1 or X2. It also may be turned on, armed, or named. Additionally, high-pass filtering, phase inversion, or EQ may be applied.</p> <p>For more information, see Selecting One or More Input Channels. See also Setting SEL to follow PFL.</p>
ON Indicator	Illuminates yellow to indicate the input channel is on.
ARM Indicator	Illuminates red to indicate the corresponding isolated track (ISO) is armed for recording.
MIXASSIST Indicator	Illuminates to indicate auto-mixing activity. When the input is open, the LED is green. As the input closes, the LED is turned off.
PFL Buttons (Pre-/Post-Fade Listen)	<p>Activates or deactivates pre- or post-fade listen of inputs 1-12 to the headphone monitor.</p> <p>For more information, see Activating PFL of an Input. See also Setting SEL to follow PFL.</p>
Linear Faders	<p>100 mm low latency linear controls for adjusting the fader levels of inputs 1-12. Ranges from Off, - 80 to +16 dB.</p> <p>Each input's linear fader gain is displayed on the mixer's Input Settings screen. Calibrate linear faders to 0 dB via the mixer's SYSTEM > Fader/Pan Calibration menu.</p>
LED Meters	Displays 7-segment pre- or post-fade metering, plus pre- and post-fade limiter LED indicator for input channels 1-12.

Right: Buttons and HP Encoder

The area that spans the right side of the mixing surface has transport controls and numerous buttons for quick access to many key features. For convenience, the buttons are grouped in sections according to common functionality.

① *Not all features described here are available with every mixer. For more information, see CL-12 Comparison Chart.*

SECTION	BUTTONS	NAME	DESCRIPTION
Transport Controls		Record	While the Transport Control on the mixer operates normally when the CL-12 is attached, this alternate, backlit Record button provides an additional control for starting a recording.
		Stop	This alternate, backlit Stop button provides an additional control for stopping a recording or playback, or (when stopped) viewing the next take's file name.
Channel Select Tools		① <i>Channel Select tools operate on the currently selected channel(s).</i>	
		ON	Press to toggle a channel on or off. When on, the input's ON LED illuminates yellow.
		ARM	Press to arm or disarm the channel. When armed, the input's ARM LED illuminates red.
		NAME	Press this button to display and edit the currently selected channel's track name. This name is embedded as metadata within the recorded files. ① <i>This functionality only works when one input is selected. If multiple inputs are selected when the NAME button is pressed, a warning message appears instructing the user to select a single input.</i>
		HPF	Press to toggle on or off high-pass filtering for a selected input channel. For more information, see Using High-pass Filters .
		Phase	Press to toggle the phase of a selected input channels. When inverted, the PHASE button illuminates orange.

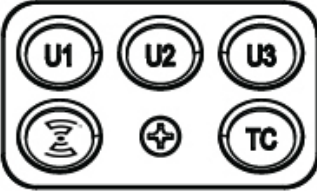
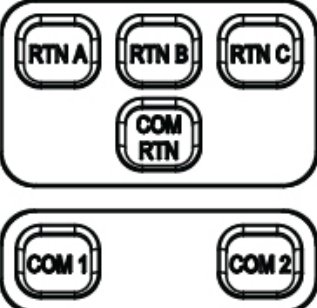
SECTION	BUTTONS	NAME	DESCRIPTION
Metadata Controls		<p>① Use the on-screen, virtual keyboard or a USB keyboard plugged into the back panel of the CL-12 to edit metadata.</p> <p>All edits update the relevant embedded metadata within the file and file name.</p>	
		SCENE	While recording, press to display and edit the current scene name. While stopped, press to display and edit the next scene name. Press SCENE again to save and exit.
		TAKE	While recording, press to display and edit the current take's Take number. While stopped, press to display and edit the next take's Take number. Press TAKE again to save and exit, or select Done.
		NOTES	While recording, press to display and edit the current take's Notes. While stopped, press to display and edit the next take's Notes. Press NOTES again to save and exit.
		INC	Increments the scene name according to settings configured via File Storage > Scene Increment Mode.
		FALSE	Moves last take to the False Takes folder and decrements the take number by 1.
		@	Toggles the circle status of the current take, which prepends the "at" symbol (@) to file name and updates the file's metadata to "circled."
Fast Access		U1, U2, U3	User definable buttons. These may be configured to many different functions in the CL-12 sub-menu.
		SuperSlot	Displays the SL-6 Receiver Overview screen, should an SL-6 be connected.
		TC	Displays the Timecode Jam menu.
COM & Return Controls		RTN A, RTN B, RTN C	Press the button corresponding to the A, B, or C return feed to be monitored in the headphones.
		COM RTN	Press to monitor COM return in the headphones.
		COM 1, COM 2	Activates the selected COM (1 or 2)

SECTION	BUTTONS	NAME	DESCRIPTION
Meters & Menu		METERS	Duplicates the functionality of the mixer's METERS button.
		MENU	Duplicates the functionality of the mixer's MENU button.

Altered Functionality

When the CL-12 is connected to a 6-Series mixer, some mixer functionality is changed. The following table indicates the functionality and which mixers are affected.

FUNCTIONALITY	688	664	633
New CL-12 submenu is enabled	✓	✓	✓
INPUTS > PFL Toggle Mode submenu is disabled	✓	✓	✓
 <i>On the 664, the submenu is called INPUTS > Input Mode.</i>			
Rotary faders (1-6) disabled	✓	✓	✓
Rotary faders (7-12) become trim controls for (7-12)	✓	—	N/A
L, R, X1, X2 adjustment via SELECT encoder is disabled	✓	✓	✓
CL-6 Rotary faders (7-12) disabled	✓	✓	N/A

Feature Comparison Chart

Feature availability is contingent on the model of the mixer to which the CL-12 is connected. The following table outlines the differences between the various 6-Series models.

CL-12 FEATURE	688	664	633
Number of linear faders	12	12	6
DC Boost micro USB power connection	Optional	Required	Required
3-band semi-parametric equalizer	✓	—	—
Auto Mixer Metering and Control	✓	—	—
SuperSlot Control	✓	—	—
COMs	1 & 2	1	—
Returns	A,B,C	A,B,C	A
Slate + Tone (via User Programmable buttons)	✓	✓	✓
SL-6 Routing (via User Programmable buttons)	✓	—	—
LR, X1, X2 Track Level Control & Metering	✓	✓	✓
Physical LR, X1, X2 Output Level Control & Metering	✓	—	—
7-segment PFL Metering + Limiter Activity	✓	✓	✓
Channel On/Off	✓	✓	✓
Headphone Level & Preset	✓	✓	✓
HPF Control	✓	7-12 only	✓

CL-12 FEATURE	688	664	633
Input Phase Control	✓	ch 2,4,6 only	ch 2 only
Input PFL and SEL Controls	✓	✓	✓
Input Routing to LR, X1, and X2	✓	✓	✓
Menu Control	✓	✓	✓
Metadata Control	✓	✓	✓
Track Arming & Naming	✓	✓	✓
Transport Control	✓	✓	✓
USB Peripherals (Light & Keyboard)	✓	✓	✓
User Programmable buttons (U1, U2, U3)	✓	✓	✓

CL-12 Sub-menu

When the CL-12 is attached to a 6-Series mixer, a new CL-12 sub-menu is available via the Main menu. Options in the menu will vary based on the mixer’s model. For instance, the left image, shown below, is the menu as it appears on a 688. The right image is the menu as it appears on a 664 or 633.

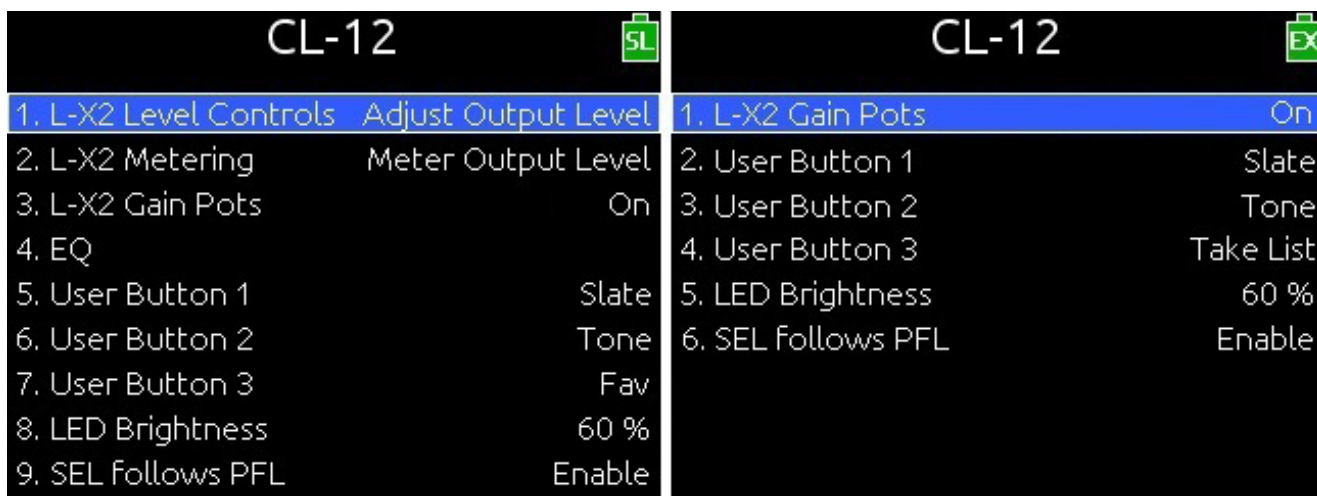

OPTION	DESCRIPTION
L - X2 Level Controls	Configure level controls to control either output or track levels. Since the 664 and 633 only allow for control of track levels, this menu option is not available when a CL-12 is connected to them. For more information, see Adjusting Output or Track Levels .
L - X2 Metering	Configure LED meters to display either output or track levels. Since the 664 and 633 only allow for metering of track levels, this menu option is not available when a CL-12 is connected to them. For more information, see Configuring Output Meters (688 only) .
L - X2 Gain Pots	Enables/disables the L, R, X1 and X2 controls on the CL-12 (OUTPUTS section).
EQ	Displays submenu related to EQ, a feature only available with the 688. For more information, see Accessing the EQ Submenu .
User Button 1	Set function of U1 button.
User Button 2	Set function of U2 button.

OPTION	DESCRIPTION
User Button 3	Set function of U3 button. For more information, see <i>Configuring User Programmable Buttons</i> .
LED Brightness	Set brightness of CL-12 LEDs. For more information, see <i>Adjusting CL-12's LED Brightness</i> .
SEL follows PFL	Enables or disables automatic selection of an input channel when its PFL button is pressed. When enabled, pressing PFL will illuminate both the PFL and SEL button for the chosen input channel. For more information, see <i>Setting SEL to follow PFL</i> .

Selecting One or More Input Channels

Input channels may be selected individually or as a group for group adjustment. One or more input channels may also be added to any previously selected group. Parameters that can be adjusted when an input channel's SEL button is selected are: ON, ARM, NAME, HPF, PHASE, EQ, and Routing to L, R, X1, X2.

① *NAME and EQ can only be adjusted for a single channel.*

To select an input channel:

▶ Press the input's SEL button.

① *Press the input's SEL button again to deselect it, or press any other SEL button to change selection.*

To select multiple input channels, do either of the following:

▶ Simultaneously press multiple SEL buttons.

▶ Press and hold one SEL button down while then pressing one or more SEL buttons for other required inputs.

① *Press any single illuminated SEL button to simultaneously deselect the group.*

To add more input channels to a selected group:

▶ Press and hold an illuminated SEL button while pressing any additional SEL buttons to add those input channels to the group.

Activating PFL of an Input

Pre- or post-fade listen may be activated on one input at a time.

To PFL an input:

- ▶ Press the input's PFL button.

There are two modes of PFL: momentary and latching.

MODES	DESCRIPTION
Momentary	If the PFL button is held for greater than one second, PFL only remains active for as long as the button is held. The mixer's LCD does not change screen.
Latching	If the PFL button is quickly tapped, PFL is "latched" on until the PFL button is tapped again or another is selected. When active, the PFL button illuminates, and the Input Settings screen for the active PFL input is displayed on the mixer's LCD.

Setting SEL to follow PFL

The CL-12 provides the SEL follows PFL option for automatic selection of an input channel when its PFL button is pressed. Think of SEL follows PFL as a fast, one-touch method for gaining access to PFL, the Input Settings screen, EQ, routing, and channel select tools. This feature may be disabled so that PFL activation and input channel selection are independent.

To enable or disable SEL follows PFL:

1. Press MENU.
2. Select CL-12 > SEL follows PFL.
3. Select one of two options: Enable and Disable.

Trim Level Adjustment on 6-Series

For inputs 1 through 6, on either the 688 or the 664, trim is still adjusted via the dedicated rotary Trim controls on the mixer, even when the CL-12 is attached. Likewise, on the 633, for inputs 1 through 3, trim is adjusted via the dedicated rotary Trim controls.

However, trim level adjustment of other inputs varies depending on the different designs of each 6-Series mixer to which the CL-12 is attached. For instance, adjusting trim on input 7 of a 688 is not the same as adjusting trim on input 7 of a 664.

The following sub-sections provide details and procedures for adjusting trim levels on inputs 7-12 on the 688, inputs 7-12 on the 664, and inputs 4-6 on the 633.

Adjusting Trim Levels (688 only)

When the CL-12 is attached to the 688, the mini-faders on the 688 become dedicated trim controls for inputs 7-12.

To adjust the trim level for inputs 7-12:

- ▶ Turn the appropriate mini-fader on the 688. The trim gain is displayed on the mixer's LCD via the Input Settings screen.

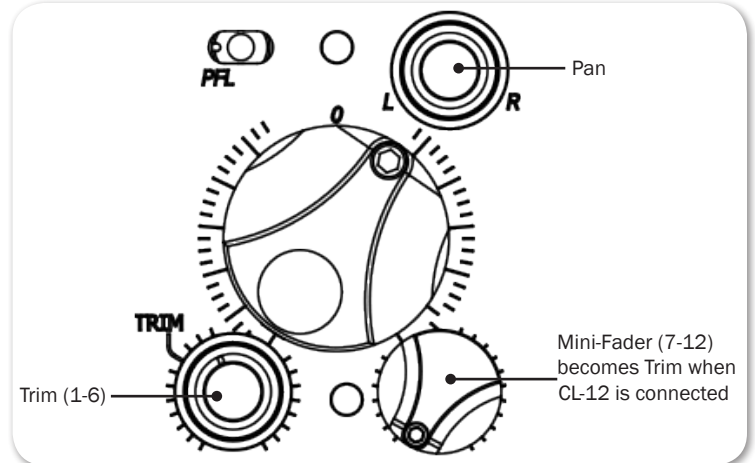

Adjusting Trim Levels (664 only)

When the CL-12 is attached to the 664, the mixer's SELECT encoder may be used to adjust trim for inputs 7-12 via the Input Settings screen.

To adjust the trim level for inputs 7-12:

1. Slide the input's PFL switch on the CL-6 to the right to access the Input Settings screen on the mixer's LCD.
2. Turn the SELECT encoder to adjust trim for the input. The trim gain is displayed on the mixer's LCD.

Adjusting Trim Levels (633 only)

When the CL-12 is attached to the 633, the mini-faders on the 633 become dedicated trim controls for inputs 4-6.

To adjust the trim level for inputs 4-6:

- ▶ Turn the appropriate mini-fader on the 633. The trim gain is displayed on the mixer's LCD via the Input Settings screen.

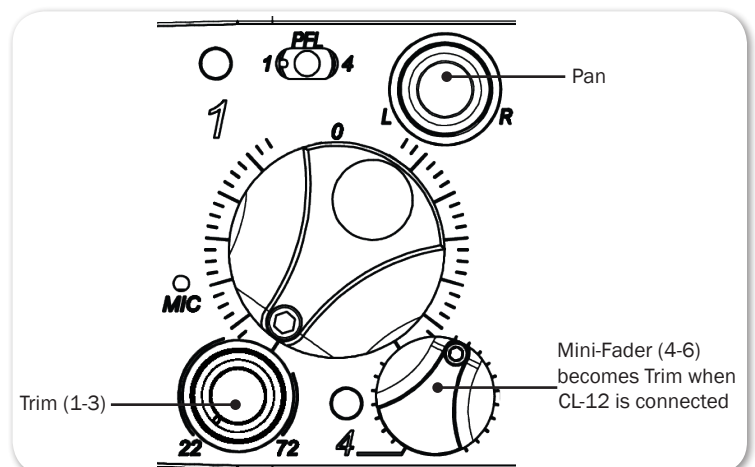

Routing Input Channels

With the CL-12, routing input channels to the left or right mix bus and the X1 or X2 output is quick and easy.

To route an input channel or multiple input channels:

- Do either of the following:
 - ▶ Press the input channel's SEL button.
 - ▶ Select multiple input channels, using their SEL buttons.
- Press the L, R, X1 or X2 output control to route to L, R, X1 or X2, respectively.

Routing to X1 or X2 can be pre- or post-fade. Press the X1 or X2 output control to cycle through the options: Route Off, Route Pre-fade, Route Post-fade. When routing is pre-fade, the X1 and X2 LEDs illuminate green. When routing is post-fade, the LEDs are yellow.

- ① *Alternatively, you can press and hold an L, R, X1, or X2 control, and then press one or more SEL button(s) for the input channel(s) you want to route to that output.*
- ① *TIP: For continuous pan control, set an input channel's routing to both L and R, then use the Pan control on the 6-Series mixer to smoothly adjust pan. This will ensure that an input's pan position will be retained when disconnecting and reconnecting the CL-12.*

Adjusting Output or Track Levels

The CL-12 has four rotary controls labeled OUTPUTS that are used for adjusting either output or track levels, based on which mixer is connected to the CL-12 and how the controls are configured.

On the 633 and 664, the CL-12's Output controls are used for adjusting track levels for L, R, X1, and X2.

On the 688, however, the CL-12's Output controls may be configured to adjust either output or track levels for L, R, X1, and X2.

To configure CL-12 output controls:

- Press MENU to access the 688's Main menu.
- Select CL-12 > L - X2 Level Controls.
- Select one of two options: Adjust Output Level or Adjust Track Level.

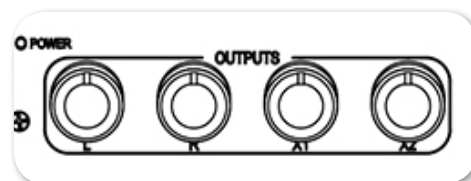

To adjust levels:

- ▶ Turn the Output control corresponding to which level you want to adjust: L, R, X1, or X2. The level value is displayed on the mixer's LCD in the HP field.

- ① *When L and R are linked, L controls level for the L/R output pair. When X1 and X2 are linked, X1 controls level for both. Also, when linked, the R and X2 controls are disabled. (Output linking control is in the OUTPUT menu.)*

Configuring Output Meters (688 only)

On a 688, the LED output meters on the CL-12 may be configured to meter L, R, X1, and X2 output or track levels. For other 6-Series mixers, the 22-segment output metering on the CL-12 is always for track levels.

To configure CL-12 output meters:

1. Press MENU to access the 688's Main menu.
2. Select CL-12 > L - X2 Metering.
3. Select one of two options: Meter Output Level or Meter Track Level.

Disabling Output Controls

The 6-Series mixers, when attached to a CL-12, has a sub-menu option that lets users disable the rotary output level controls for L, R, X1, and X2 to avoid accidental changes in level.

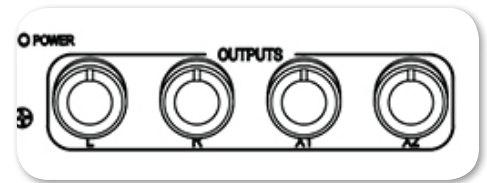

To disable the output controls on the CL-12:

1. Press MENU.
2. Select CL-12 > L-X2 Gain Pots.
3. Select Off. This setting is On by default.

- ① *Even when disabled, users can still route to L, R, X1, and X2 by pressing in the controls (pots). Also, disabling the CL-12 output level controls does not impact controls on the mixer. Attenuation of output may still be achieved via the mixer.*

Arming L, R, X1, X2 Tracks

With the CL-12, L, R, X1 and X2 may be armed for recording, or unarmed.

To arm L, R, X1, X2 tracks for recording:

1. Press and hold down the ARM button.
2. Press the rotary OUTPUT control(s) corresponding to the output track(s) you want to arm.

When armed, each output track's ARM LED illuminates red.

Using the 3-Band Equalizer (688 only)

The CL-12 adds 3-band EQ to the 688. EQ is only available when sample rate is 48.048 kHz or less, and it is only available for adjustment when CL-12 is connected.

- LF is a fixed 100 Hz EQ by default, with +/- 12 dB gain adjustment. The default may be altered via settings in the EQ submenu.
- MID provides variable EQ frequency adjustment over 400 Hz – 6k range with +/- 12 dB gain adjustment.
- HF is a fixed 10 kHz EQ by default, with +/- 12 dB gain adjustment. The default may be altered via settings in the EQ submenu.

① *When CL-12 is disconnected, the EQ settings are retained, but they cannot be adjusted. For more information, see [Accessing the EQ Submenu](#).*

To adjust EQ for a selected input, do any of the following:

- ▶ Turn the LF encoder to adjust the selected input's low frequency gain.
- ▶ Turn the FREQ encoder to adjust the selected input's MID frequency.
- ▶ Turn the GAIN encoder to adjust the selected input's MID gain.
- ▶ Turn the HF encoder to adjust the selected input's high frequency gain.

Above the SEL button for each input, the EQ LED illuminates blue when any of the LF, MID, or HF are set to non-zero gain, giving a quick global indication that some form of equalizer is applied to the input(s).

If a selected input has LF applied, the LF LED illuminates orange.

If a selected input has MF applied, the MID LED illuminates yellow, and if a selected input has HF applied, the HF LED illuminates green.

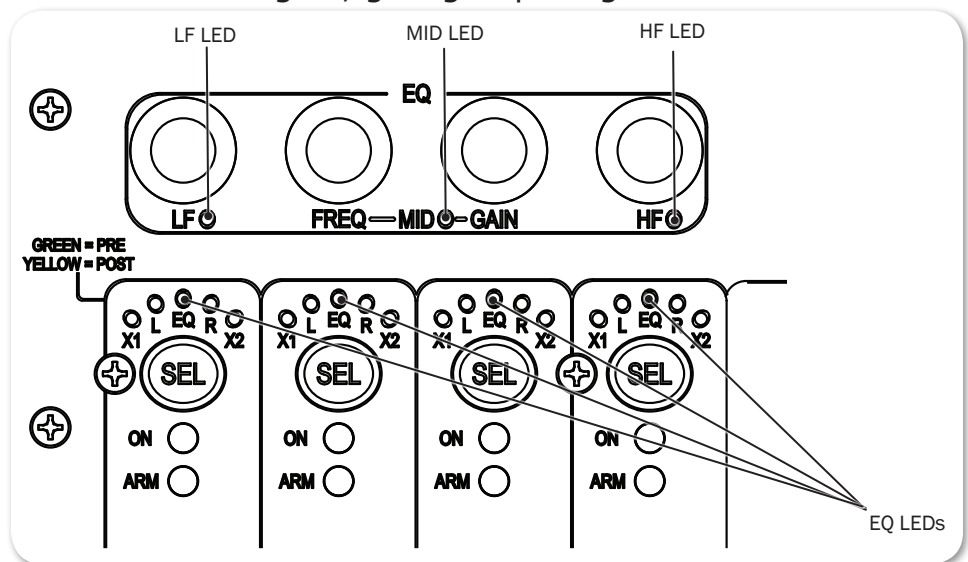

When EQ is applied to a selected input, the EQ screen also appears for the selected input on the mixer's LCD. For instance, in the following example, EQ is applied to channel 1 (CH-1); LF is set at 10 dB and HF is set to -10 dB, while MID frequency and gain are bypassed. In the example, high-pass filtering is off, the Q-factor is set to 1.0 and both LF and HF filtering is set to Peaking.

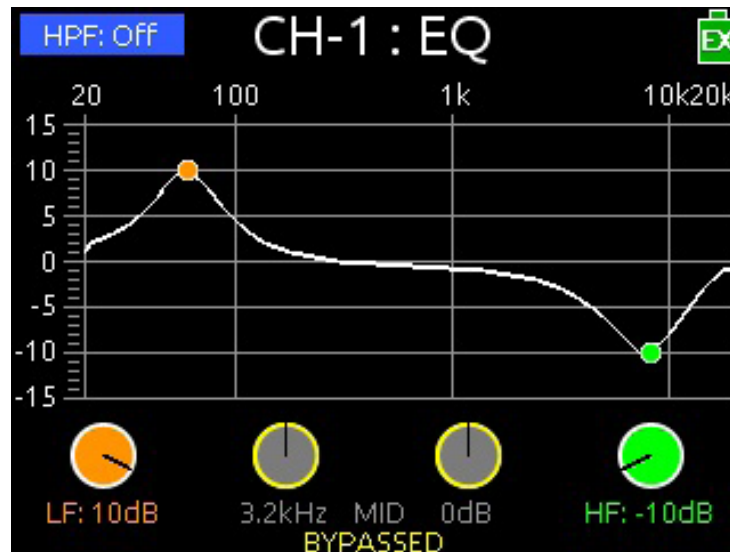

It is not possible to adjust EQ for multiple inputs at the same time. When multiple input channels are selected, the channel that is adjusted will be the last one added to the group.

There is a 10-second timeout on the EQ screen, if nothing is adjusted.

- ① *Press and hold an input's SEL button while pressing any of the EQ encoders to view the input's EQ screen without changing the input's EQ value.*

Accessing the EQ Submenu

Several settings related to EQ—such as Q-factor, EQ routing, and so forth—may be configured via the EQ submenu.

To access the EQ submenu:

1. Press MENU.
2. Select CL-12 > EQ. The EQ submenu appears.

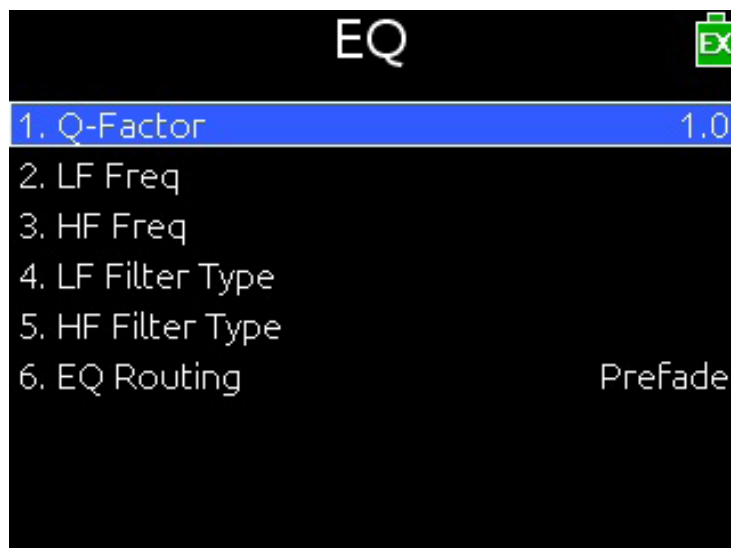

OPTION	DESCRIPTION
Q-Factor	Set to one of four values: 0.707, 1.0, 1.414, 2.0. This affects all EQ bands. For more information, see Setting the Q-Factor .
LF Freq	Values range from 60 Hz to 300 Hz. Default is 100 Hz. This may be adjusted individually for each channel.
HF Freq	Values range from 8 kHz to 16 kHz. Default is 10 kHz. This may be adjusted individually for each channel. For more information, see Setting LF and HF Frequency Defaults .
LF Filter Type	Set to either Peaking or Shelving. This may be adjusted individually for each channel.
HF Filter Type	Set to either Peaking or Shelving. This may be adjusted individually for each channel. For more information, see Setting LF and HF Filter Types .
EQ Routing	Set to either Pre-fade or Post-fade. This affects all input channels. For more information, see Setting EQ Routing .

Bypassing EQ

When necessary, it is possible to temporarily and quickly bypass the application of EQ without altering the current non-zero gain value. The label **BYPASSED** is shown on the EQ screen for any band that is bypassed.

To bypass EQ do any of the following:

- ▶ Press the LF encoder.
- ▶ Press the FREQ or GAIN encoder.
- ▶ Press the HF encoder.

These controls act as toggles between bypass (gain = 0 dB) and the last non-zero gain value, so pressing any encoder a second time will toggle off bypass and reapply the last non-zero gain value for LF, MID, or HF respectively.

When an EQ band is bypassed, its EQ LED goes out.

Setting the Q-Factor

The Q-factor controls the bandwidth that will be cut or boosted by the equalizer.

To set the Q-factor:

1. Press MENU.
2. Select CL-12 > EQ > Q-Factor.
3. Select one of the following options: 0.707, 1.0, 1.414, or 2.0.

The lower the setting, the wider the bandwidth, which means more frequencies will be affected by EQ. The higher the setting, the narrower the bandwidth, so the EQ adjustment will be more selective.

For example, the following two images show a 10 dB LF peaking filter applied to CH-1; however, the Q-factor for the left one is set to 0.707, while the Q-factor for the right one is set to 2.0.

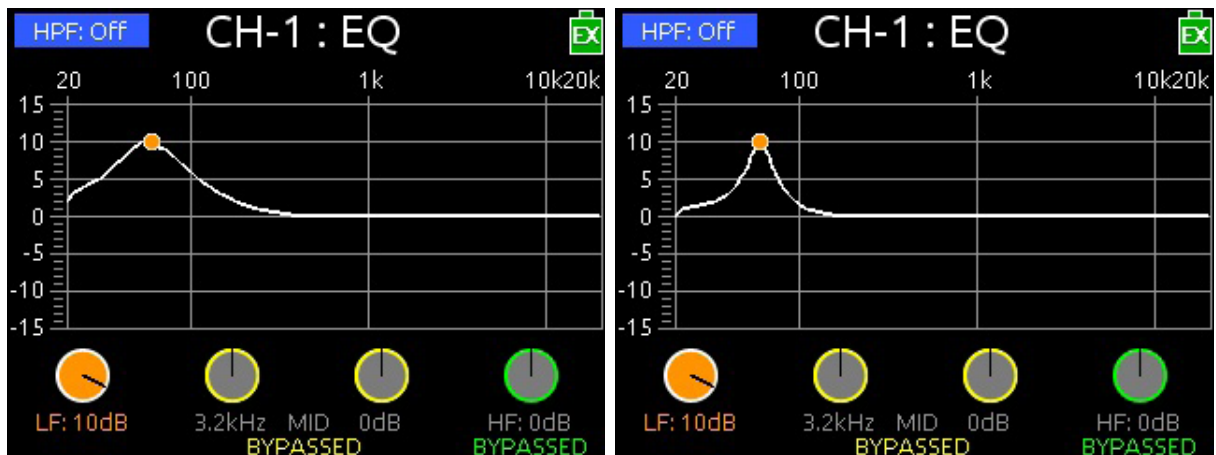

Setting LF and HF Frequency Defaults

The default for LF is 100 Hz and the default for HF is 10 kHz, but both may be adjusted for each individual input via setting in the EQ submenu.

To adjust LF and HF Freq. defaults:

1. Press MENU.
2. Select CL-12 > EQ.
3. Do the following:
 - ▶ Select LF Freq and set a new value. Options include values in increments of 10 from a minimum 60 Hz to maximum 300 Hz.
 - ▶ Select HF Freq and set a new value. Options include values in increments of 10 from a minimum 8 kHz to maximum 16 kHz.

Setting LF and HF Filter Types

The CL-12's EQ offers two types of filters: Peaking and Shelving, and these may be adjusted individually for each input.

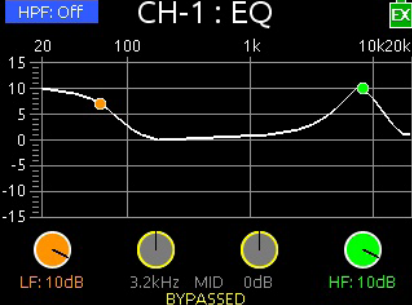
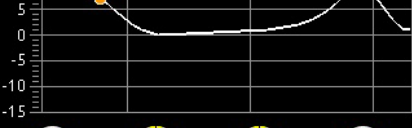
FILTER	SAMPLE IMAGE	DESCRIPTION
Peaking		A peaking filter will create a hill- or peak-like boost or cut around a particular frequency. The spread of the "peak" will vary based on the Q-factor.
Shelving		A shelving filter will slope up or down to a particular point and remain constant at its level of boost or cut.
The sample image shows examples of both shelving (LF) and peaking (HF).		

To set type of LF and HF filters:

1. Press MENU.
2. Select CL-12 > EQ.
3. Do the following:
 - ▶ Select LF Filter Type and set each input to either Peaking or Shelving.
 - ▶ Select HF Filter Type and set each input to either Peaking or Shelving.

Setting EQ Routing

EQ may be applied either pre- or post-fade. This setting globally affects all inputs.

To set EQ routing:

1. Press MENU.
2. Select CL-12 > EQ > EQ Routing. Options include: Pre-fade or Post-fade.

Using High-pass Filters

The High-pass Filter (HPF) button on the CL-12 is a toggle, which turns the high-pass filter off or on for the selected input.

On the 664, since inputs 1-6 are analog, the CL-12's HPF button toggles on or off high-pass filtering for inputs 7-12 only at the fixed frequency of 150 Hz.

On the 688 and 633, the high-pass filter may be adjusted for all inputs to other frequencies.

To turn on and adjust an input's high-pass filter:

1. Select an input, using the input's SEL button.
 2. Press the HPF button.
- ① *If inputs 1-6 are selected on the 664 when the CL-12's HPF button is pressed, a message will appear: "Use the low-cut control on the 664 front panel."*

The HPF button illuminates when high-pass filtering is on.

3. (633 & 688 only) Adjust the HPF value via the Input Settings screen.

When high-pass filtering is on, the HPF value is fixed at 150 Hz on the 664, but may be changed via in the Input Settings screen on the 633 or 688. Also, on the 688, the EQ screen appears on the mixer's LCD. The Headphone encoder may be used as an alternative way to adjust the HPF value displayed on the EQ screen.

- ① *Press the HPF button again to turn off the high-pass filter.*

Naming Tracks

Since inputs are hard-wired to their respective tracks, the input name is the same as the track name. Naming functionality only applies to one selected input at a time. Attempting to do so with multiple inputs selected will result in a message instructing the user to select a single input before continuing.

While recording, the current take's track name may be modified. Edits to the track name in the current take will also be applied to the next take and subsequent recordings that follow. The next take's track name may be edited so long as recording is stopped.

To enter or edit track names:

1. With a single input selected, press the NAME button. The Track Name List appears over the Meters View.
2. Do any of the following:
 - ▶ Select Edit Entry to edit the current entry.
 - ▶ Select Add New Entry to enter a new track name.
 - ▶ Select a name from the list.

① *TIP: Prepare a list of names to use for fast selection during production.*

Configuring User Programmable Buttons

The CL-12 offers three user programmable buttons for quick-access to a wide range of functions and menus.

To configure U1 – U3 buttons:

1. Press MENU.
2. Select CL-12 > User 1-3 buttons.
3. Select an option to assign to the button. The following table shows possible options and whether they are available with the different 6-Series mixers:

OPTION	DESCRIPTION	688	664	633
Take List	Displays the Take List screen.	✓	✓	✓
File List	Displays the File List screen.	✓	✓	✓
Play	Toggles between play and pause.	✓	✓	✓
FFWD	Fast forward or skip to next file.	✓	✓	✓
REW	Rewind or skip to previous file.	✓	✓	✓
Slate	Toggles slate on and off.	✓	✓	✓
Tone	Toggles tone on and off.	✓	✓	✓
FAV	Duplicates the action of the FAV switch.	✓	—	✓
Select	Duplicates the action of pressing the Select encoder.	✓	✓	✓
Default Playback Card	Shortcut to FILE STORAGE > Default Playback Card sub-menu.	✓	✓	✓
Power Menu	Displays the POWER settings.	✓	—	✓
Input Delays	Displays the Input Delays screen.	✓	—	✓
Output Delays	Displays the Output Delays screen.	✓	—	✓
LR Linking	Toggles linking of L and R.	✓	✓	✓
X1/X2 Linking	Toggles linking of X1 and X2.	✓	✓	✓
Auto Mixer	Toggles the Auto Mixer (MixAssist or Dugan) on and off.	✓	—	—
Return Loopback Mode A - C	Three options: Enters Return Loopback modes for either RTN A, RTN B, or RTN C, respectively.	✓	—	—
SLATE ROUTING	Displays the Slate Routing screen.	✓	—	✓
TONE ROUTING	Displays the Tone Routing screen.	✓	—	✓
Timecode Menu	Displays the Timecode/Sync menu.	✓	✓	✓
Daylight Mode	Toggles daylight mode.	✓	✓	✓
Create Sound Report	Creates a sound report (.csv file).	✓	✓	✓
Sound Report Info	Displays the Sound Report Info screen.	✓	✓	✓
X1 - X6 Routing	Six options: Each one is a shortcut to OUTPUTS > X1-X6 Routing > X1 Routing, X2 Routing, and so forth, respectively.	✓	—	X1-X4 only
SL-6 Routing	Displays the SL-6 Routing screen.	✓	—	—
AES Routing	Displays the AES Output Routing screen.	✓	✓	✓
EQ Menu	Shortcut to CL-12 > EQ sub-menu.	✓	—	—
LF Freq	Displays the EQ LF FREQ settings.	✓	—	—
HF Freq	Displays the EQ HF FREQ settings.	✓	—	—

Adjusting CL-12's LED Brightness

Depending on the work environment, the brightness of the CL-12's LED may require adjustment.

To adjust LED brightness:

1. Press MENU and scroll to CL-12.
2. Select LED Brightness.
3. Turn the Headphone encoder to adjust value up or down in 1% increments from a minimum of 5% up to 100%.

① *TIP: LED brightness may be further boosted by connecting a USB 5 V source to the DC Boost Input port on the back panel of the CL-12.*

Replacing Side Panels

The CL-12 Alaia comes equipped with custom, hand-crafted hardwood side panels; however, included with the CL-12 Alaia is the Aluminum Endcap Kit, which contains a set of black aluminum side panels like those on the standard CL-12 model.

To replace the wood with metal side panels:

1. Use the 1/16-inch hex L key, supplied with the kit, to remove the 9 button-head screws and washers from each side of the CL-12 Alaia. The wood side panels will then come off.
2. Position each black aluminum side panel so that the holes in the panel are aligned with threaded holes in the CL-12 Alaia's chassis.
3. Use the screws, supplied with the kit, to fasten the panels, and tighten with a Phillips-head screwdriver (not supplied).

Specifications

The following specifications apply to the CL-12.

NAME	DESCRIPTION	
External Power	<ul style="list-style-type: none"> Powered by the mixer via USB cable 5V micro USB DC boost input (required for use with 664 or 633) 	
Current Draw	<ul style="list-style-type: none"> 90mA @5V typical 	
Light	<ul style="list-style-type: none"> 100 mA (when powered by 688) 500 mA (when powered with external USB power supply) 	
Size (W x D x H)	CL-12 <ul style="list-style-type: none"> 14.7 in x 11.3 in x 3.8 in 37.3 cm x 28.7 cm x 9.6 cm 	CL-12 Alaia <ul style="list-style-type: none"> 15.2 in x 11.3 in x 3.8 in 38.6 cm x 28.7 cm x 9.6 cm
Weight	<ul style="list-style-type: none"> 5 lbs 2.27 kg 	<ul style="list-style-type: none"> 5 lbs 2.27 kg

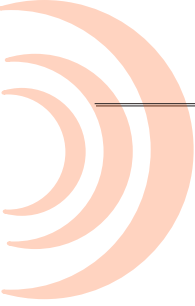

Manufactured by PortaBrace for Sound Devices, this production case was designed for use with the 633 Compact Field Production Mixer.

Front pocket provides space for wireless receivers and/or NP-1 battery. The bottom panel opens and expands to provide access to rear-mounted L-Series batteries.

Included:

- CS-633 Production Case
- Nylon Handle Strap with Metal Clips
- Heavy-duty Suede Handle



Features

The production case is made from durable Cordura, padded with internal reinforcements for shock resistance, durability, and temperature insulation.

Other features include:

- Divider/compartiment insert for securing wireless transmitters or receivers separate from other gear.
- Large side access openings with drawstrings.
- Accessory compartment for wireless transmitters, receivers, or batteries.
- Quick trap door access to rear-mounted L-Series batteries.
- Includes removable windowed cover.
- Velcro pocket provides convenient storage of cue sheets, etc.

Specifications

NAME	DESCRIPTION
Dimensions	<ul style="list-style-type: none">• 9 in x 7 in x 5.714 in• 22.86 cm x 17.78 cm x 14.51 cm
Weight	<ul style="list-style-type: none">• 1.25 lbs• 0.567 kg



Software License

End-user license agreement for Sound Devices 6-Series Software / Embedded Firmware

Important Read carefully:

This Sound Devices, LLC end-user license agreement ("EULA") is a legal agreement between you (either an individual or a single entity) and Sound Devices, LLC for the Sound Devices, LLC software product identified above, which includes computer software, embedded firmware, and may include associated media, printed materials, and "online" or electronic documentation ("SOFTWARE PRODUCT"). By using, installing, or copying the SOFTWARE PRODUCT, you agree to be bound by the terms of this EULA. If you do not agree to the terms of this EULA, do not use or install the SOFTWARE PRODUCT.

Software Product License

The SOFTWARE PRODUCT is protected by copyright laws and international copyright treaties, as well as other intellectual property laws and treaties. The SOFTWARE PRODUCT is licensed, not sold.

Grant of license. This EULA grants you the following limited, non-exclusive rights: In consideration of payment of the licensee fee, Sound Devices, LLC, as licensor, grants to you, the licensee, a non-exclusive right to use this copy of a Sound Devices, LLC software program (hereinafter the "SOFTWARE") on a single product and/or computer. All rights not expressly granted to licensee are reserved to Sound Devices, LLC.

Software ownership. As the licensee, you own the hardware on which the SOFTWARE is recorded or fixed. Sound Devices, LLC shall retain full and complete title to the SOFTWARE and all subsequent copies of the SOFTWARE, regardless of the media or form on or in which the original copies may exist. The license is not a sale of the original SOFTWARE.

Copyright

All rights, title, and copyrights in and to the SOFTWARE PRODUCT (including, but not limited to, any images, photographs, animations, video, audio, music, text, and "applets" incorporated into the SOFTWARE PRODUCT) and any copies of the SOFTWARE PRODUCT are owned by Sound Devices, LLC or its suppliers. The SOFTWARE PRODUCT is protected by copyright laws and international treaty provisions. Therefore, you must treat the SOFTWARE PRODUCT like any other copyrighted material, except that you may make copies as only provided below. You may not copy the printed materials accompanying the SOFTWARE PRODUCT.

Restrictions on use. Licensee may not distribute copies of the SOFTWARE or accompanying materials to others. Licensee may not modify, adapt, translate, reverse engineer, decompile, disassemble, or create derivative works based on the SOFTWARE or its accompanying printed or written materials.

Transfer restrictions. Licensee shall not assign, rent, lease, sell, sublicense, or otherwise transfer the SOFTWARE to another party without prior written consent of Sound Devices, LLC. Any party authorized by Sound Devices, LLC to receive the SOFTWARE must agree to be bound by the terms and conditions of this agreement.

Termination

Without prejudice to any other rights, Sound Devices, LLC may terminate this EULA if you fail to comply with the terms and conditions of this EULA. In such event, you must destroy all copies of the SOFTWARE PRODUCT and all of its component parts.

Limited Warranty

No warranties. Sound Devices, LLC expressly disclaims any warranty for the SOFTWARE PRODUCT. The SOFTWARE PRODUCT and any related documentation is provided "as is" without warranty or condition of any kind, either express or implied, including, without limitation, the implied warranties and conditions of merchantability, fitness for a particular purpose, or non-infringement. The entire risk arising out of use or performance of the SOFTWARE PRODUCT remains with you.

No liability for damages. In no event shall Sound Devices, LLC or its suppliers be liable for any damages whatsoever (including, without limitation, damages for loss of business profits, business interruption, loss of business information, or any other pecuniary loss) arising out of the use of or inability to use this Sound

Devices, LLC product, even if Sound Devices, LLC has been advised of the possibility of such damages. In any case, Sound Devices, LLC's entire liability under any provision of this evaluation license shall be limited to the greater of the amount actually paid by you for the SOFTWARE PRODUCT or U.S. \$5.00. Because some states/jurisdictions do not allow the exclusion or limitation of liability for consequential or incidental damages, the above limitation may not apply to you.

Governing Law

This agreement and limited warranty are governed by the laws of the state of Wisconsin.

SOUND DEVICES

Sound Devices, LLC
E7556 Road 23 and 33
Reedsburg, Wisconsin 53959
USA

Phone: +1 (608) 524-0625
Fax: +1 (608) 524-0655

Customer Support

Toll Free: (800) 505-0625

Email: support@sounddevices.com
<http://www.sounddevices.com/support>
<http://forum.sounddevices.com>

Product Information

For more information about products and accessories, visit us on the web at www.sounddevices.com.

Report Documentation Error

Email: techpubs@sounddevices.com

