

USER MANUAL

**NANLUX**

INNOVATE · ILLUMINATE

# *Evoked 1200B*

*LED BI-COLOR SPOT LIGHT*

[WWW.NANLUX.COM](http://WWW.NANLUX.COM)

# Contents

<b>Product Diagram</b> .....	01	2. CCT Button .....	34
<b>Technical Data</b> .....	01	3. EFFECT Button (effect types and operations) .....	36
<b>Product Details</b> .....	02	4. MENU Button .....	51
<b>Detailed Description</b> .....	03	① OUTPUT MODE .....	51
<b>Usage</b>		② ADDRESS/DMX .....	52
1. Connection Between Light Fixture and Power Supply .....	04	③ WIRELESS CONTROL .....	52
2. Installation and Detachment of Yoke .....	06	④ FAN CONTROL .....	52
3. Installation and Detachment of Reflector .....	10	⑤ ROTATE SCREEN .....	53
4. Installation and Detachment of AS-CP-QR-EV Quick Release Clamp .....	11	⑥ SCREEN BRIGHTNESS .....	54
		⑦ BUTTON BACKLIGHT .....	55
		⑧ LANGUAGE .....	56
		⑨ FIRMWARE UPDATE .....	57
		⑩ VERSION .....	59
<b>Remote Control</b>		5. LOCK Button .....	59
1. ADDRESS/DMX .....	12	<b>Safety Precautions</b> .....	60
2. DMX Control .....	14	<b>Notice</b> .....	60
3. Wireless Control .....	19	<b>General Fault Detection and Diagnosis</b> .....	60
4. RDM Control .....	33	<b>Product Includes</b> .....	61
<b>Operating Instructions</b>			
1. Display Screen Interface Instructions .....	34		

# *Evoked* 1200B LED Bi-Color Spot Light

## ■ Product Diagram

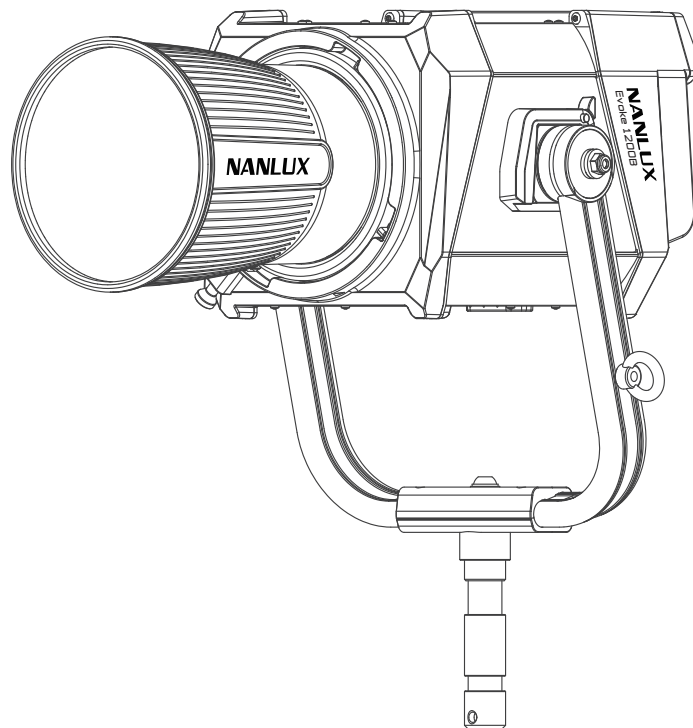

## ■ Technical Data

Rated power: 1200W

Input voltage/current: DC48V/25A Max

AC100-240V 50/60Hz

Color Temperature: 2700K-6500K

CRI: Average 96

TLCI: Average 97

ta=45°C

# Product Details

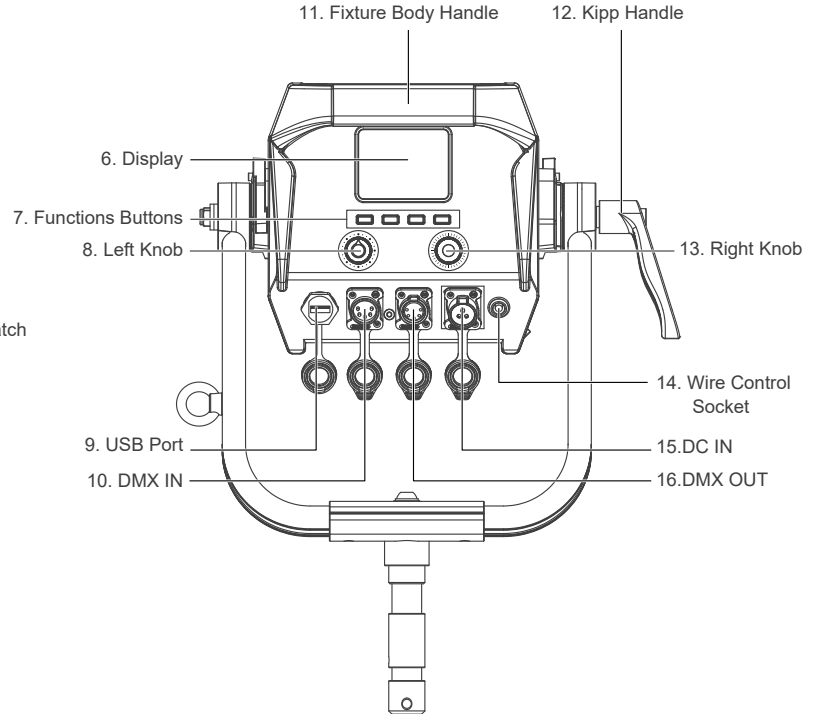
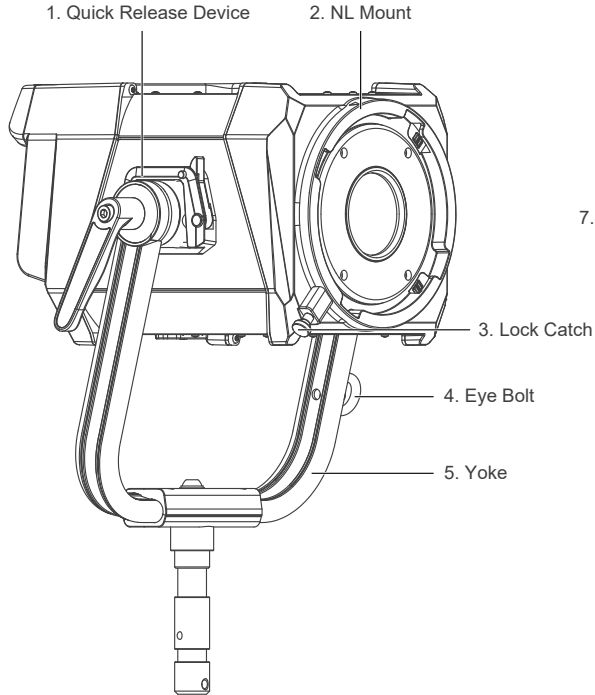



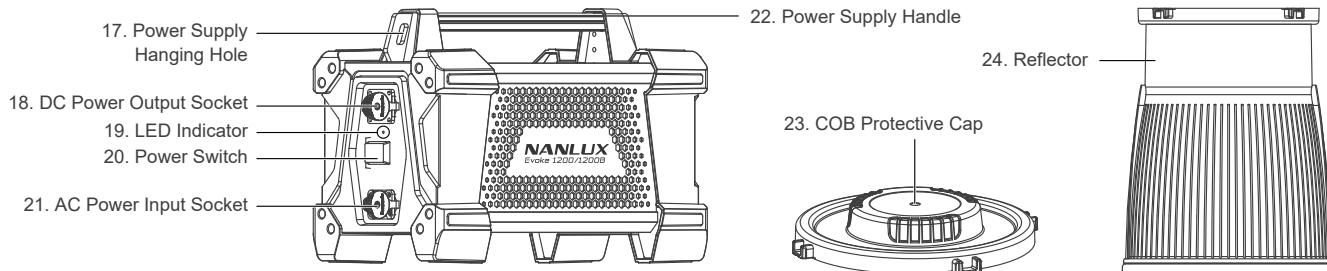

## Detailed Description

1. Quick release device: For quick installation and detachment of yoke.
2. NL mount: For installing the reflector or other NL mount accessories.
3. Lock catch: To lock or release the reflector or other accessories. Note: Please pull in the direction indicated on it.
4. Eye bolt: For hanging safety rope.
5. Yoke: Mount the fixture on a stand, also for pan and tilt.
6. Display: To display data.
7. Functions buttons: Including CCT, EFFECT, MENU and LOCK.
8. Left knob: For adjusting brightness and other parameters.
9. USB port: For updating firmwares or connecting USB cable to external devices with maximum current of 5V/1A.
10. DMX IN: DMX signal input interface.
11. Fixture Body Handle: Offer convenient grip for adjusting direction of illumination.
12. Kipp handle: Tighten or release the tilt movement of the fixture on the yoke.
13. Right knob: For selecting options.
14. Wire control socket: Wire control interface.
15. DC IN: DC power input interface.
16. DMX OUT: DMX signal output interface.
17. Power supply hanging hole: For hanging the power supply.
18. DC power output socket: For connecting the fixture to the power supply with DC cable.
19. LED indicator: For judging the status of power input. Being on, means power supply normal; Flashing or being off, mean power supply abnormal or no power input.
20. Power switch: To turn on/off the fixture.
21. AC power input socket: For connecting AC cable and supplying power to power supply.

- 22. Power supply handle: For lifting the power supply.
- 23. COB protective cap: For protection purpose, please cover the COB with the cap when not in use.  
(Note: Take off the cap before using.)
- 24. Reflector: For concentrating light to improve the central illumination.

## Usage

### 1. Connection Between Light Fixture and Power Supply

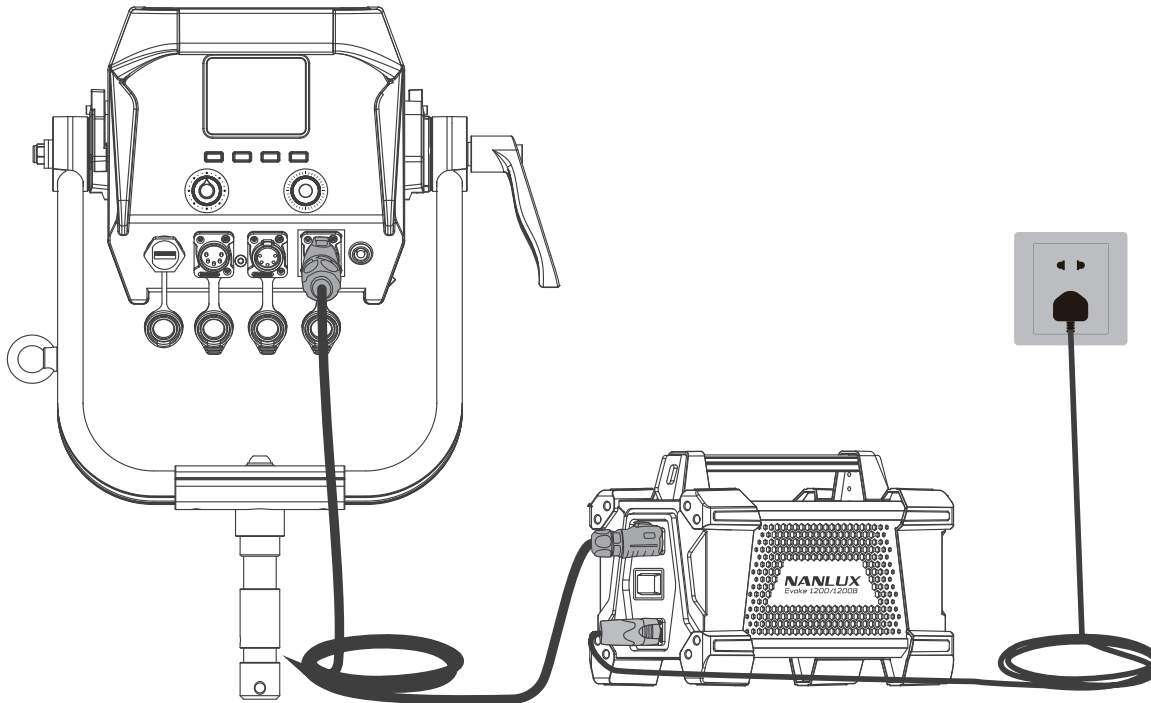

- ▲ Note: 1. When connecting the power supply, please make sure the power, voltage and frequency are consistent with that indicated on the included power supply.  
2. Make sure to use the included power supply and power cable. The connection between the DC plug and the DC IN power input socket on the fixture should be connected as below shown.

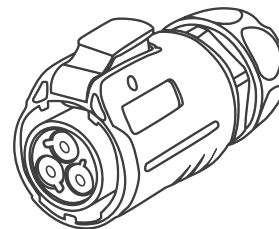
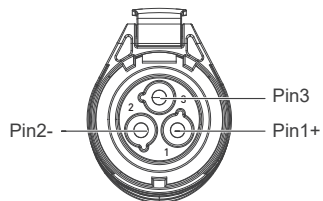
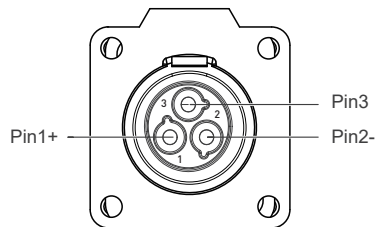

- Pin1+: Connect with power supply +  
Pin2-: Connect with power supply -  
Pin3: Grounding wire

2. Installation and Detachment of Yoke

① Quick release yoke diagram

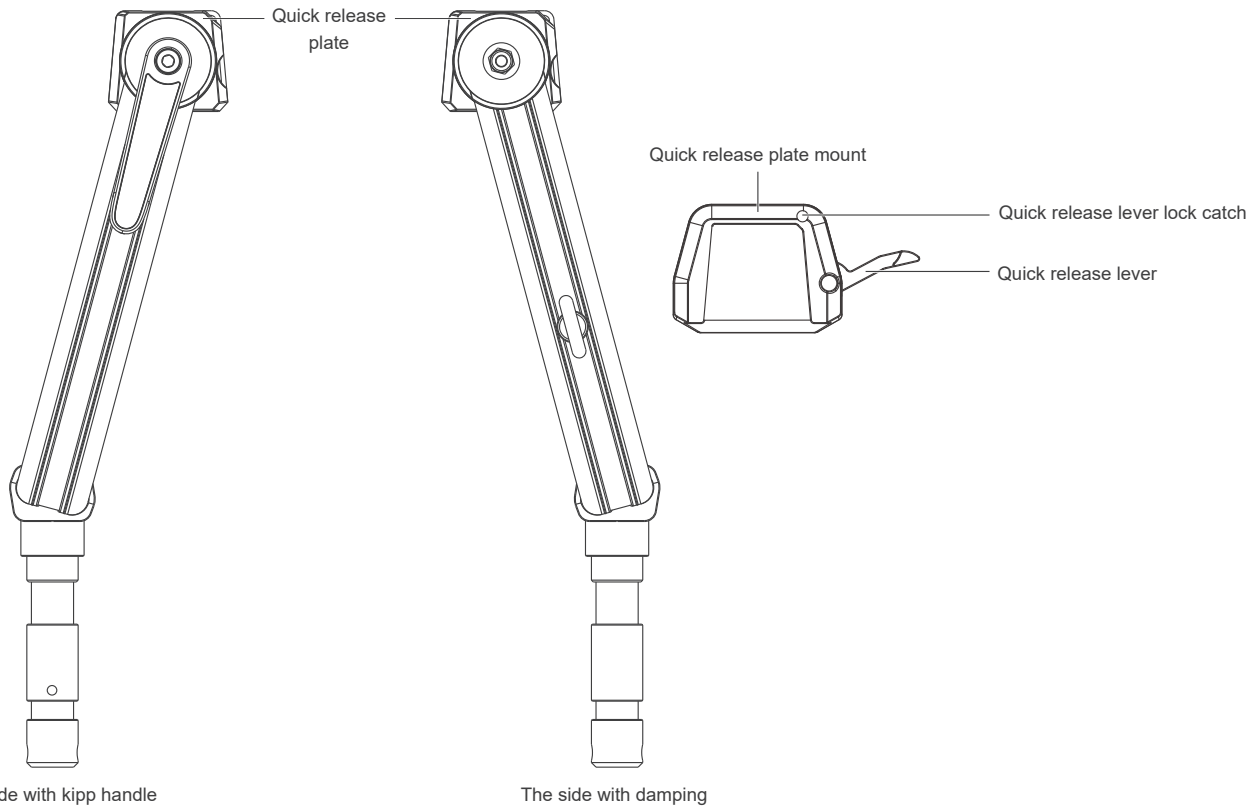

② Installation of Yoke (Method One)

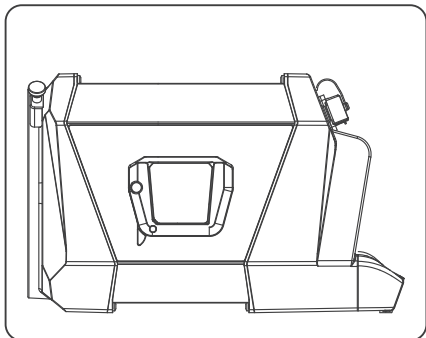

Lay down the light fixture on flat ground, with its bottom up.

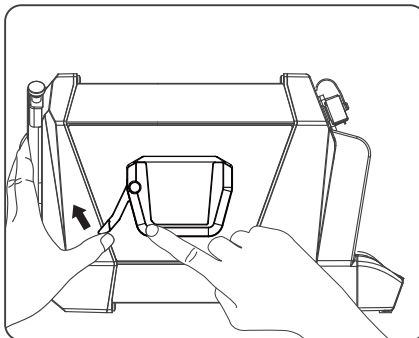

Press the quick release lever lock catch to release the lever, and push the lever aside.

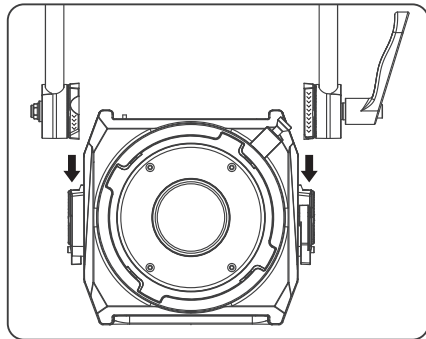

Align and insert the quick release plates to the mounts on both sides of the fixture.

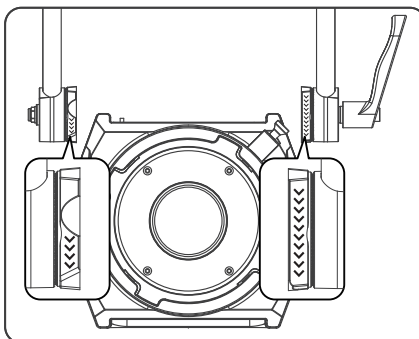

Note: Please adjust the plate to right directions when installing the quick release plate, then insert them into the mount.

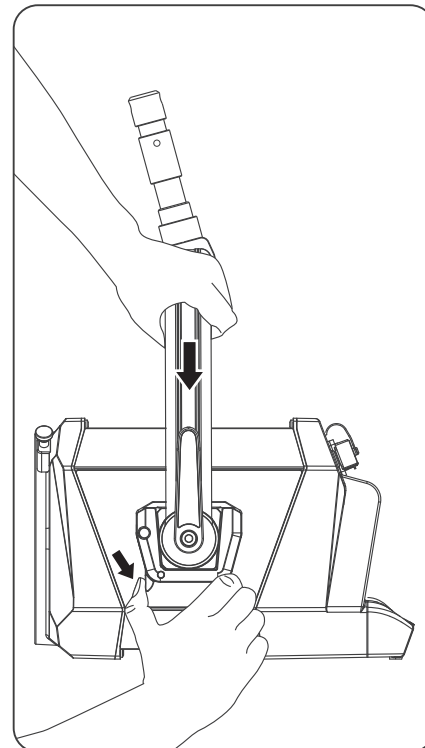

Firmly hold the yoke in place with one hand, and pull the quick release lever with the other hand to lock the plate.

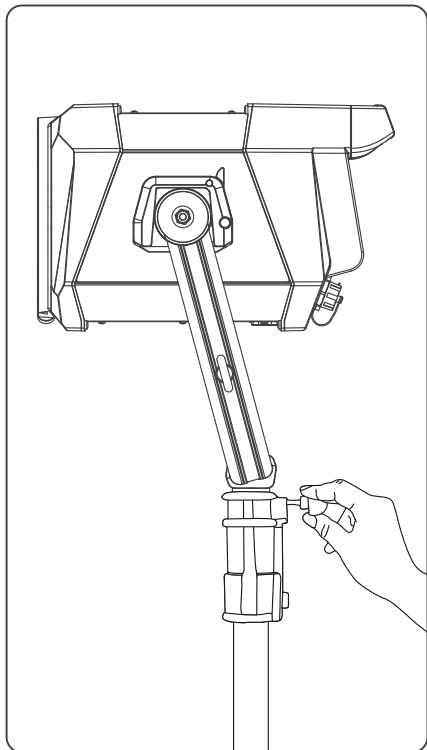

Mount the fixture on heavy-duty light stand and lock the fastening screws on the light stand.

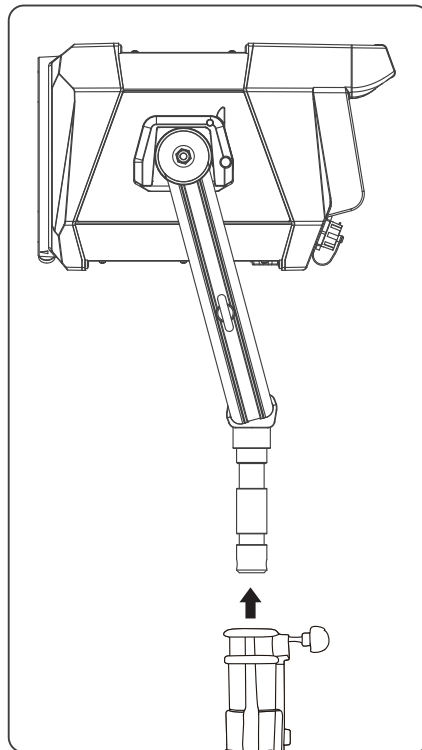

When disassembling the yoke, remove the fixture from the heavy-duty light stand first and lay it down on flat ground.

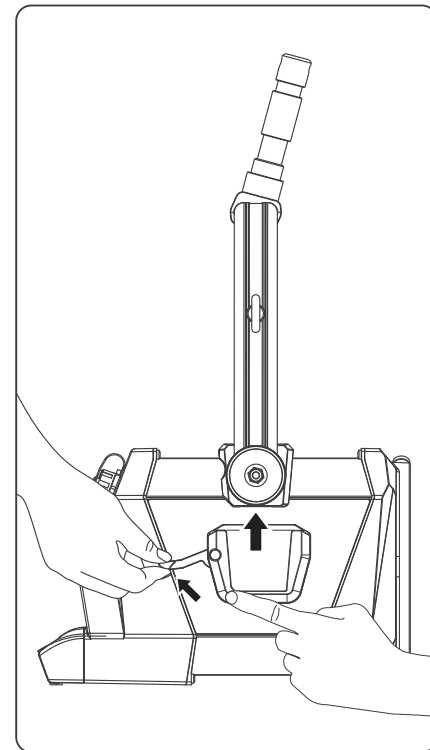

Press the quick release lever lock catch of the fixture on both sides, then release the quick release lever to remove the fixture.

③ Installation of Yoke (Method Two)

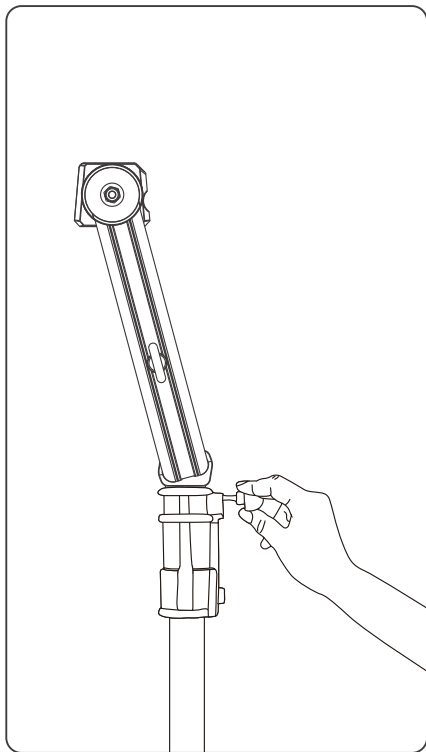

Mount the yoke on heavy-duty light stand and lock the fastening screws on the light stand.

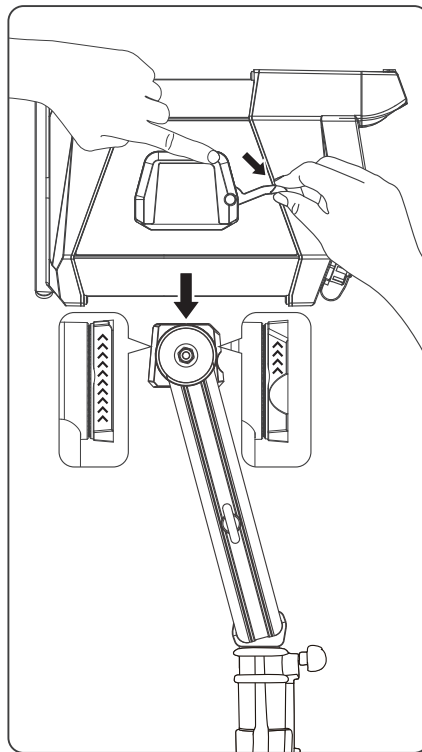

Press the quick release lever lock catch and push the lever aside, align and insert the quick-release plate mounts to the plates of the yoke.

(Note: Please adjust the plate to right directions when installing the quick release plate, then insert them into the mount.)

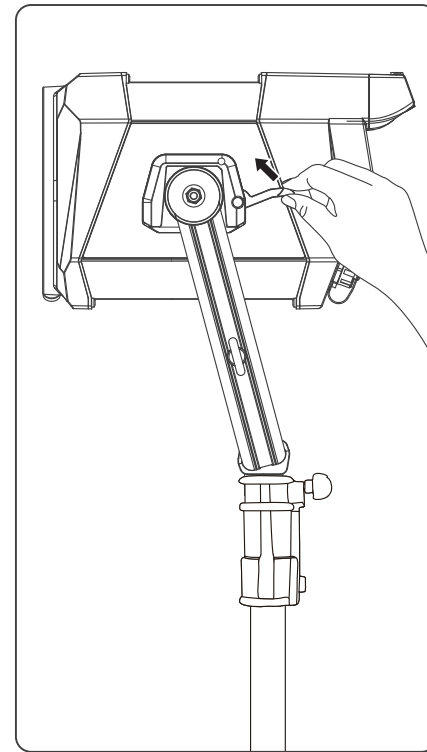

Pull the levers on both sides of the fixture to lock the quick release plate in place. The installation of the yoke is completed.

3. Installation and Detachment of Reflector

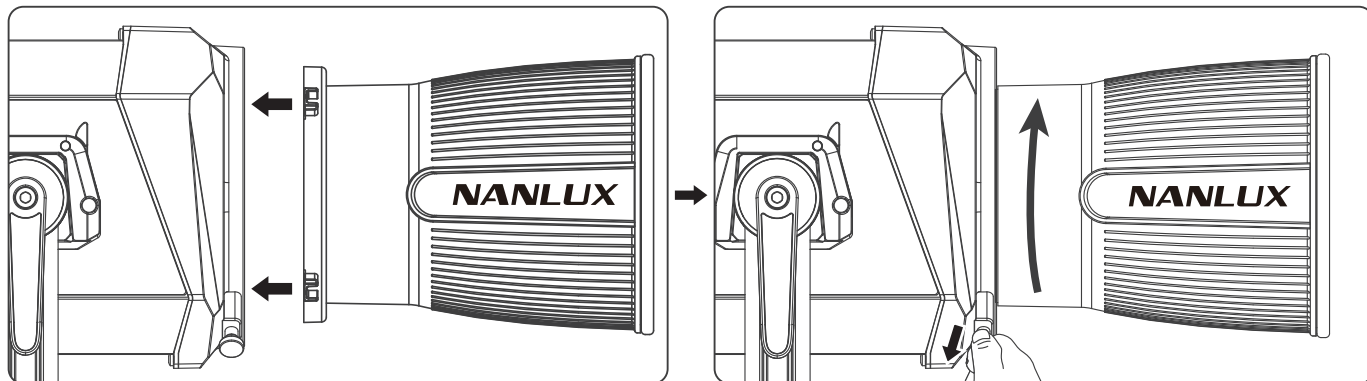

When installing the reflector, align the reflector's bayonet lock to the light's mount, rotate the reflector clockwise and fasten the reflector on the light.  
 (Note: if the rotation is not smooth, pull the lock catch of the mount and rotate the reflector at the same time.)

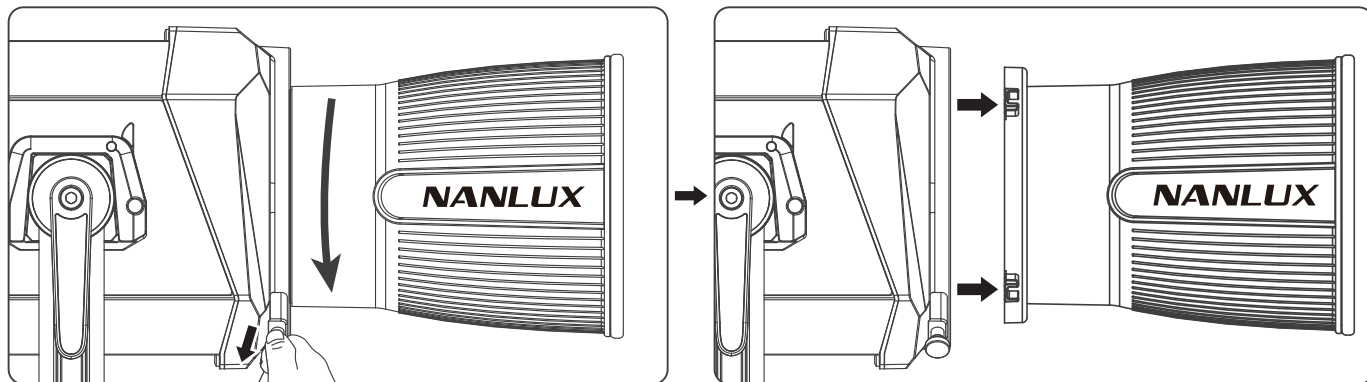

When removing the reflector, pull the lock catch of the mount, rotate the reflector anticlockwise and remove.



4. AS-CP-QR-EV Evoke Quick Release Clamp Installation

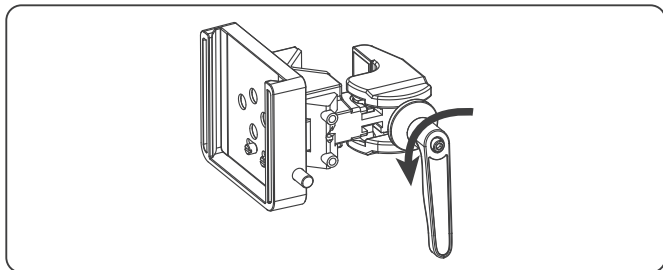

Rotate the kipp handle to release the clamp.

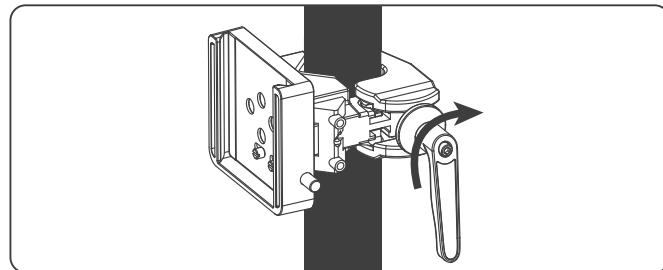

Mount the quick release clamp on the light stand, then rotate the kipp handle to tighten the clamp.

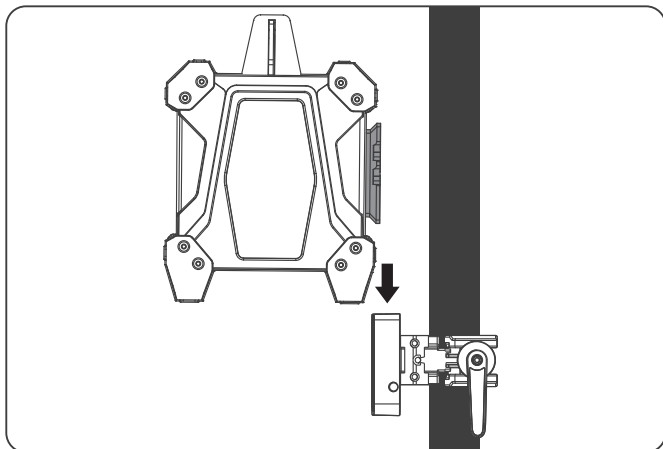

Align the quick release plate on the power supply with the quick release mount on the clamp, a click sound will be heard when the power supply is fastened in place.

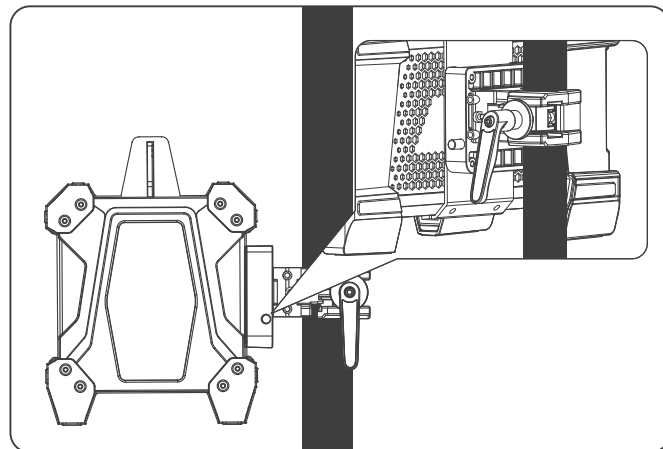

Press the lock catch on the clamp to remove the power supply from the light stand.

# Operating Instructions

· Evoke 1200B supports remote control via 2.4G, DMX/RDM and LUMENRADIO, and includes a built-in Bluetooth module as well.

▲The ADDRESS needs to be set before operating the remote control via 2.4G, DMX/RDM and LUMENRADIO.

1. ADDRESS/DMX, including ADDRESS, DMX MODE, DMX REDUCED CHANNELS, DMX DIMMING CURVE and DMX SMOOTHING settings.

## ①ADDRESS

Press MENU button to access options.

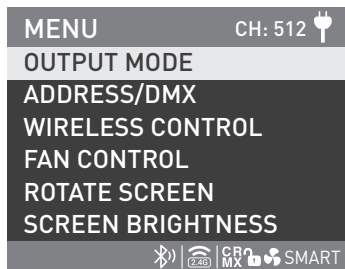

Left knob



Right knob

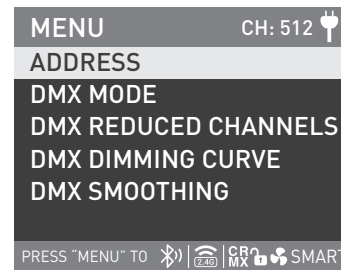
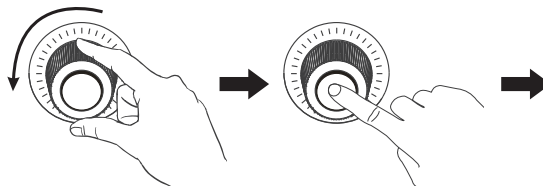
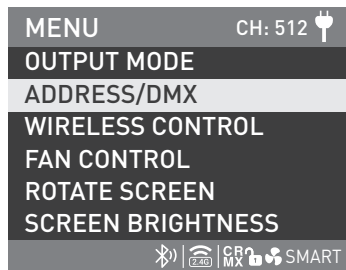
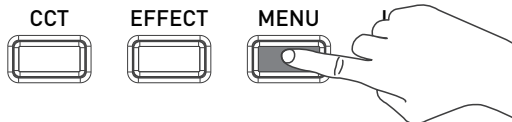

Rotate the "right knob" to ADDRESS/DMX, and press the "right knob" to enter the corresponding secondary menu.

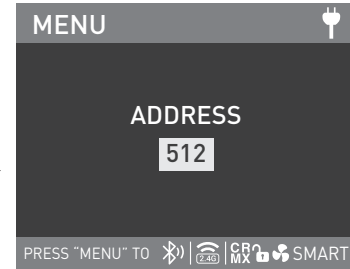
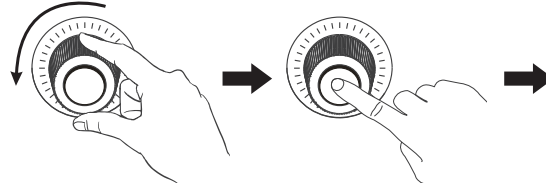
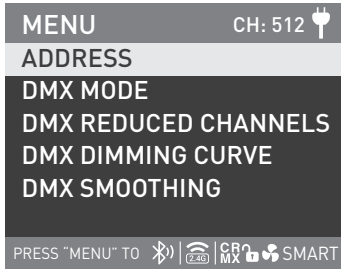

Rotate the "right knob" to ADDRESS, press the "right knob" to enter the corresponding tertiary menu.

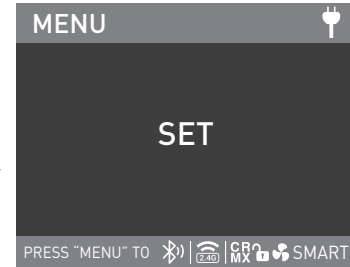
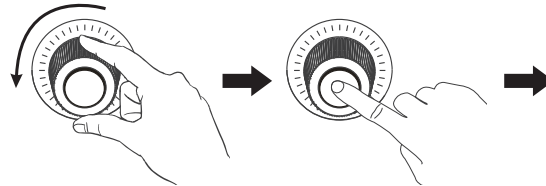
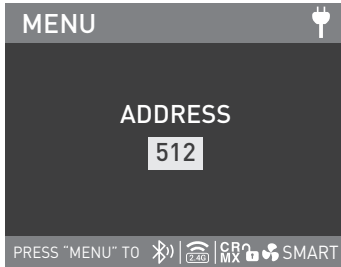

Rotate the "right knob" to select address number and press the "right knob" to set.

②DMX MODE

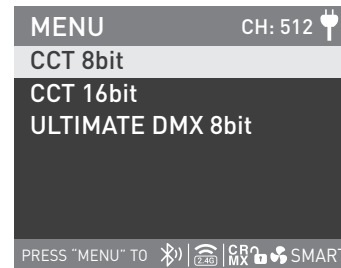
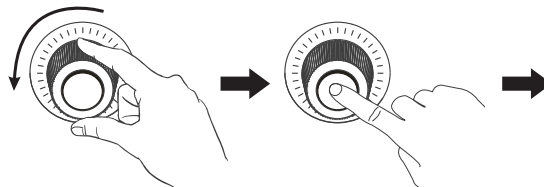
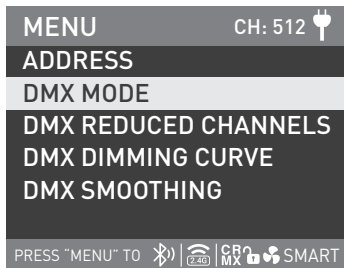

Rotate the "right knob" to DMX MODE and press the "right knob" to enter the corresponding tertiary menu.

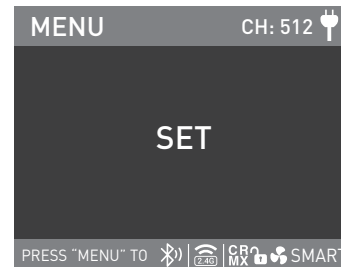
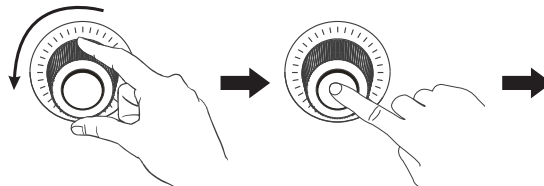
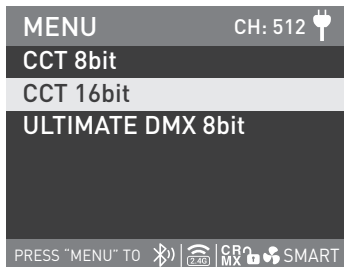

Rotate the "right knob" to select CCT 8bit, CCT 16bit or ULTIMATE DMX 8bit, and press the "right knob" to set.

③ DMX REDUCED CHANNELS

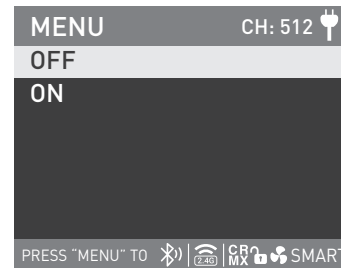
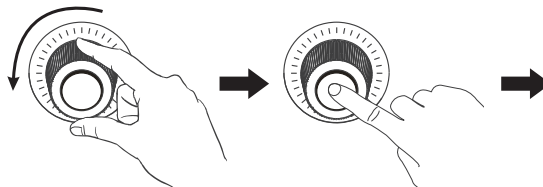
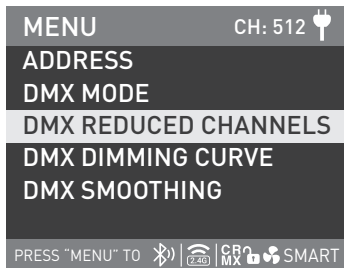

Rotate the "right knob" to DMX REDUCED CHANNELS, and press the "right knob" to enter the corresponding tertiary menu.

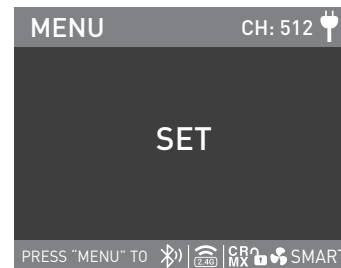
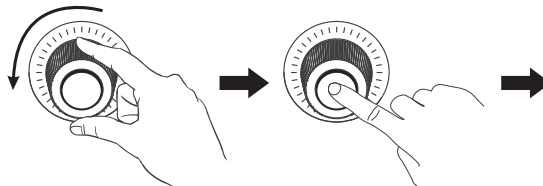
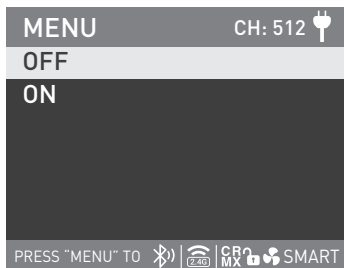

Rotate the "right knob" to select ON or OFF and press the "right knob" to set.

④ DMX DIMMING CURVE

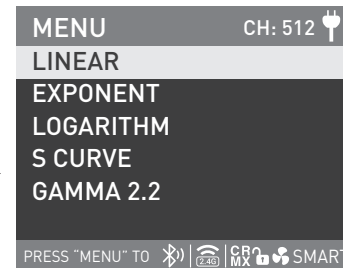
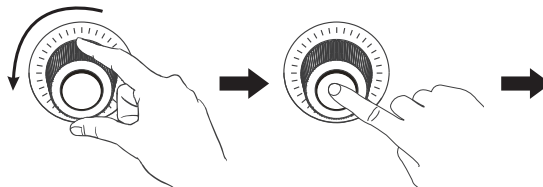
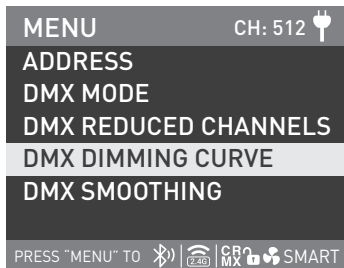

Rotate the "right knob" to DMX DIMMING CURVE, and press the "right knob" to enter the corresponding tertiary menu.

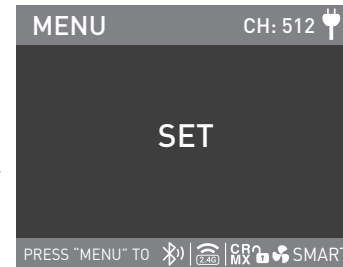
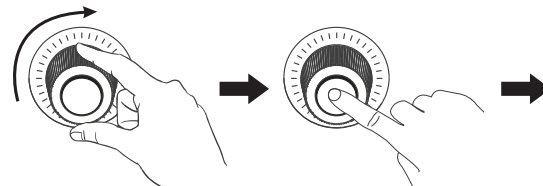
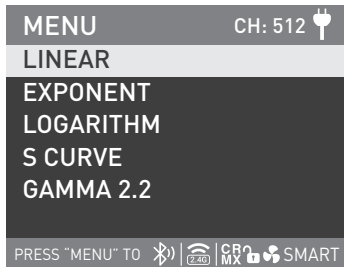

Rotate the "right knob" to select LINEAR, EXPONENT, LOGARITHM, S CURVE or GAMMA 2.2, and press the "right knob" to set.

⑤ DMX SMOOTHING

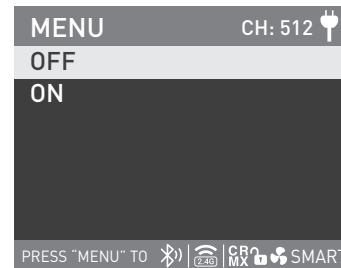
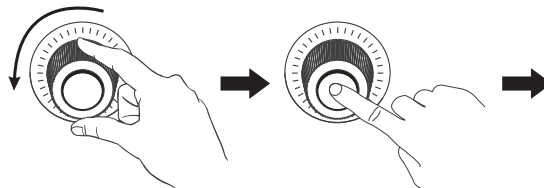
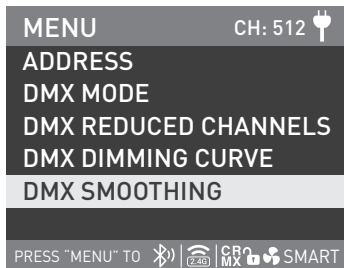

Rotate the "right knob" to DMX SMOOTHING and press the "right knob" to enter the corresponding tertiary menu.

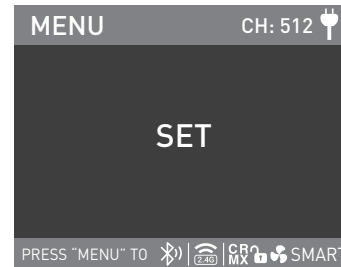
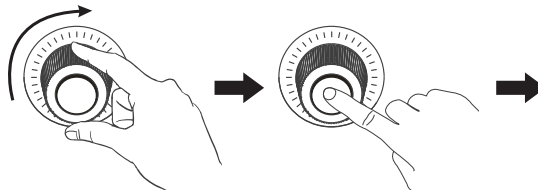
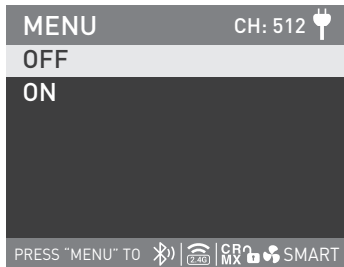

Rotate the "right knob" to select ON or OFF and press the "right knob" to set.

2. DMX Control

① Connect the light fixture and the DMX512 console using the connection cable, as below.



- 5-pin shielded cable with a diameter not less than 0.3mm must be used for connection between light fixture and DMX/RDM console, or between light fixture and light fixture. XLR plug/socket and the cable should be connected as picture above.
- Pin1, Pin2, Pin3 for connecting DMX signal. Pin4, Pin5 has no connection.

▲NOTE: When connecting DMX, make sure the internal pin is not in contact with the inner case. The fixture can match the DMX512 (1990) control signal.

- 5-pin and 3-pin XLR plug/socket conversion

The fixture comes with 5-pin XLR plug/socket. If a 3-pin XLR plug is used, please follow the instruction below.

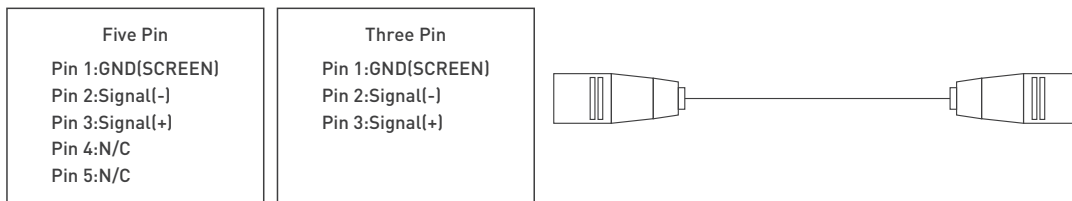

②DMX Terminator

In DMX control mode, the DMX output of the last fixture should be connected with a DMX terminator (Not included). This prevents interference caused by DMX signals in the transmitting process. The terminator is connected with a 120Ω(OHM) resistor across Pin 2 and Pin 3. (As shown below)

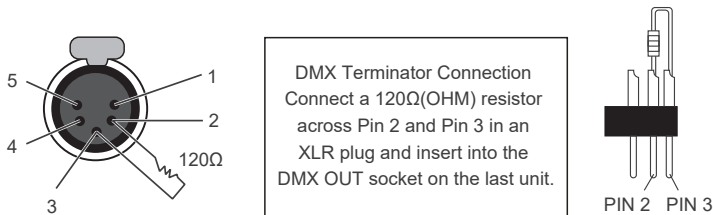

③ADDRESS Setting.

- ④Refer to the attached DMX reference guide and control the light via DMX/RDM console.

(For specific operation methods, please refer to the DMX/RDM console operation manual.)

Note: DMX reference guide «Evoke 1200B DMX REFERENCE GUIDE» please download it from [www.nanlux.com](http://www.nanlux.com).



### 3. WIRELESS CONTROL

#### ① BLUETOOTH SETTINGS

The Evoke 1200B has built-in Bluetooth connection functionality, so it can be controlled via Bluetooth module.

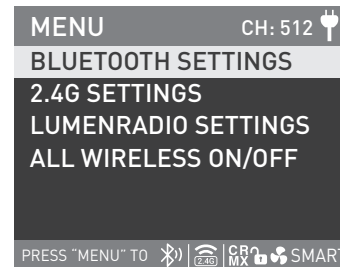
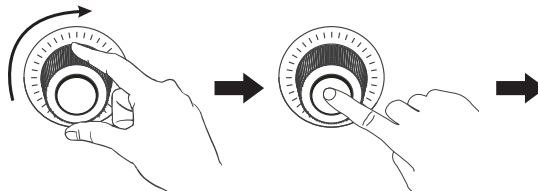
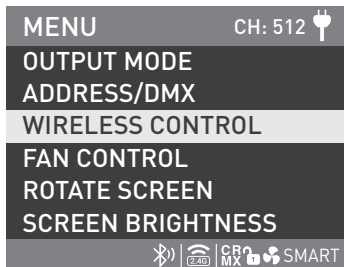

Rotate the "right knob" to WIRELESS CONTROL, and press the "right knob" to enter the corresponding secondary menu.

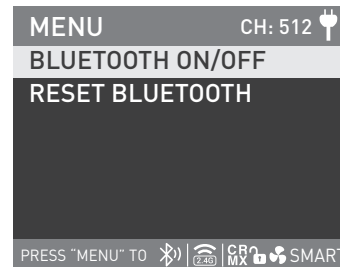
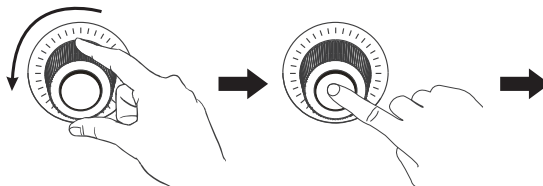
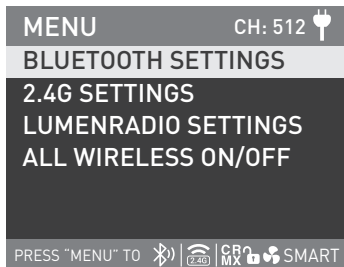

Rotate the "right knob" to BLUETOOTH SETTINGS, and press the "right knob" to enter the corresponding tertiary menu.

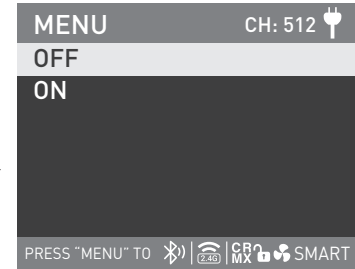
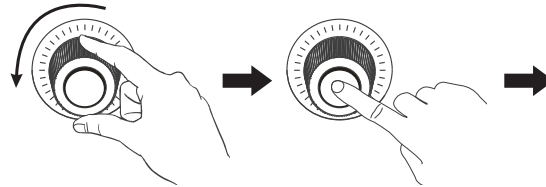
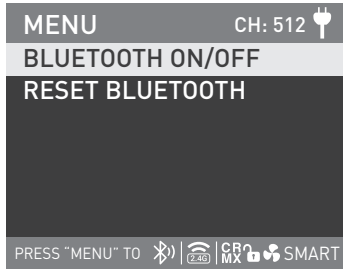

Rotate the "right knob" to BLUETOOTH ON/OFF, and press the "right knob" to enter the corresponding next level menu.

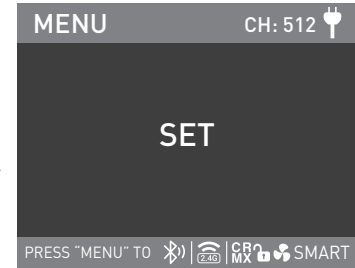
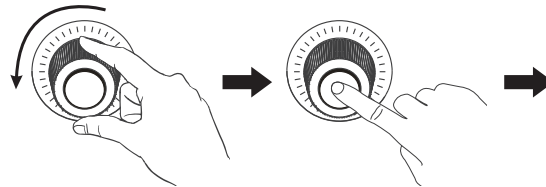
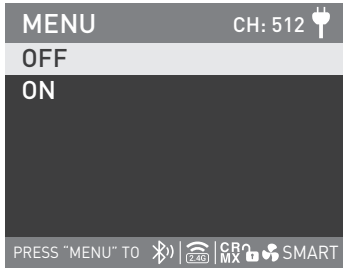

Rotate the "right knob" to select ON or OFF, and press the "right knob" to set.

· The RESET BLUETOOTH is available when the Bluetooth is on.

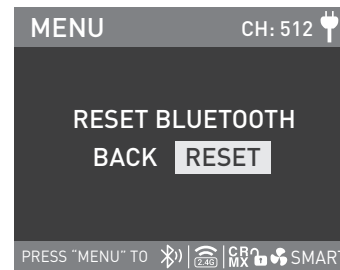
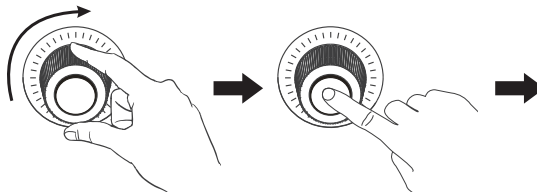
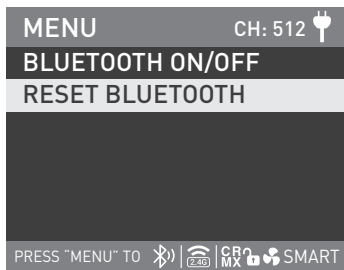

Rotate the "right knob" to RESET BLUETOOTH, and press the "right knob" to enter the corresponding next level menu.

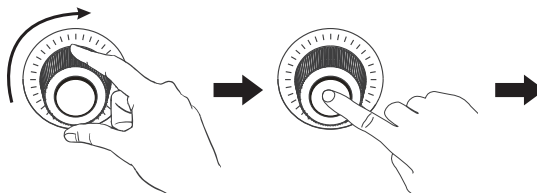
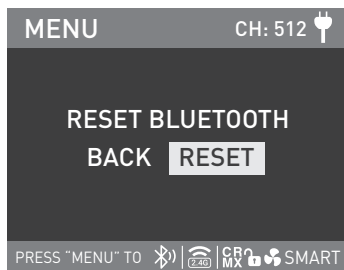

Rotate the "right knob" to select RESET, and press the "right knob" to set.

②2.4G SETTINGS

· Evoke 1200B can be remotely controlled by 2.4G remote controller or NANLINK transmitter box.

Note: (1) 2.4G remote controller and NANLINK transmitter box are sold separately.

(2) The fixture supports the 2.4G wireless protocol V1.0 and V2.0. The fixture should be set in V2.0 while using WS-RC-C1 or WS-RC-C2 remote controller, set in V1.0 while using other remote controllers.

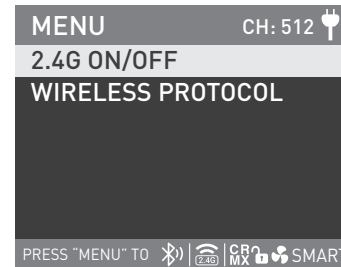
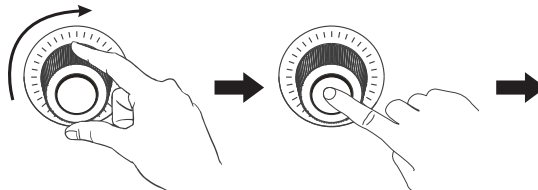
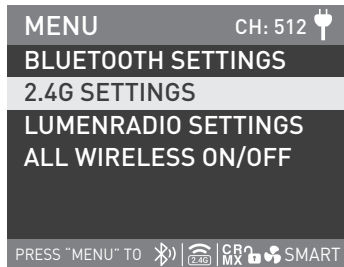

Rotate the "right knob" to 2.4G SETTINGS, and press the "right knob" to enter the corresponding tertiary menu.

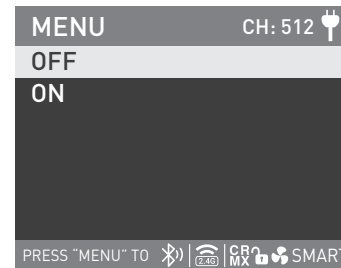
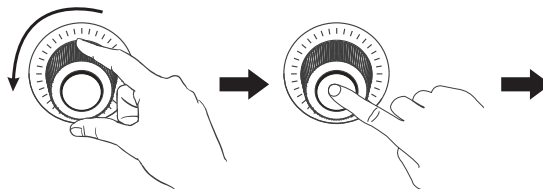
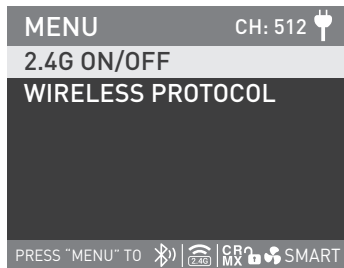

Rotate the "right knob" to 2.4G ON/OFF, and press the "right knob" to enter the corresponding next level menu.

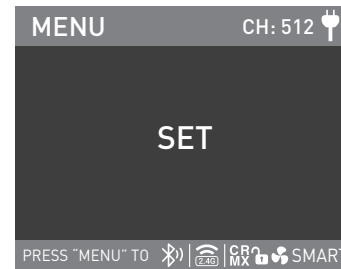
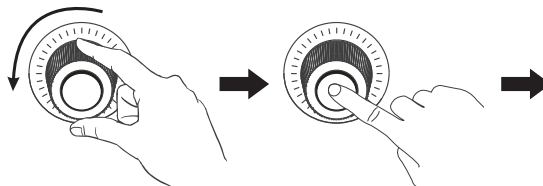
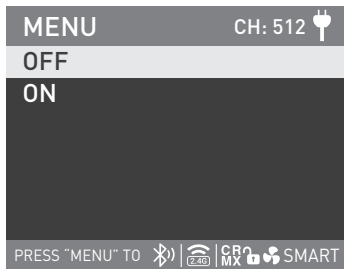

Rotate the "right knob" to select ON or OFF, and press the "right knob" to set. The 2.4G wireless control is available when the 2.4G is set to be on.

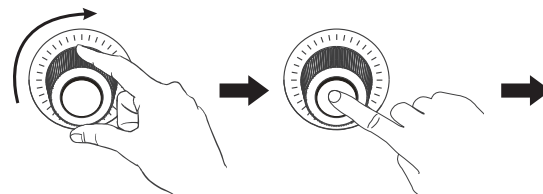
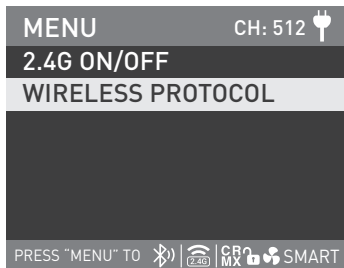

Rotate the "right knob" to WIRELESS PROTOCOL, and press the "right knob" to enter the corresponding next level menu.

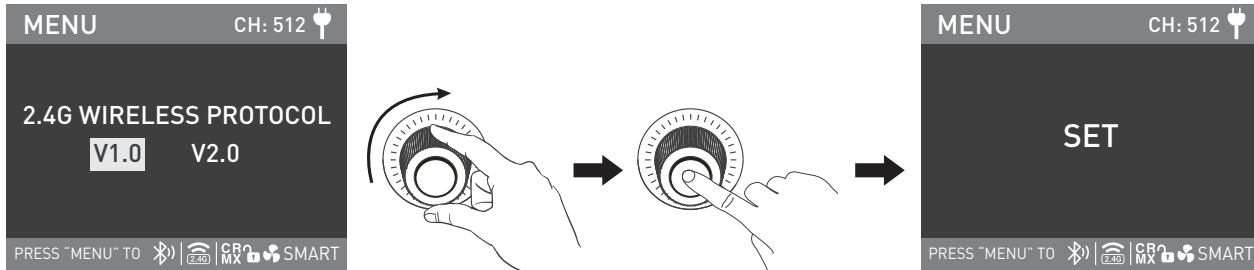

Rotate the "right knob" to select V1.0 or V2.0, and press the "right knob" to set.

③ LUMENRADIO SETTINGS

- Evoke 1200B has built-in CRMX TIMOTWO module, enabling it to receive and send CRMX wireless DMX signals. The specific operations are as below: press MENU to enter the interface.

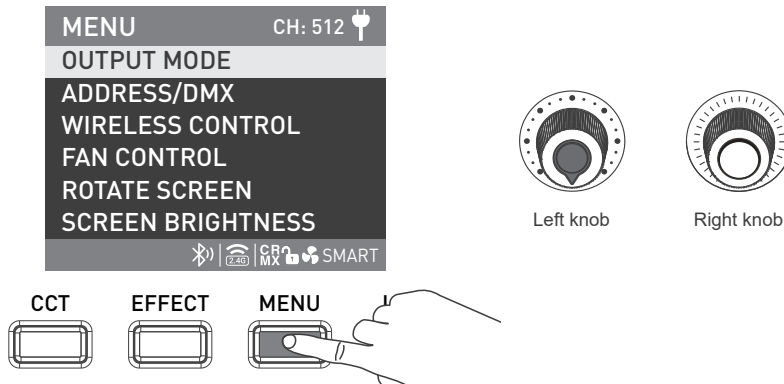

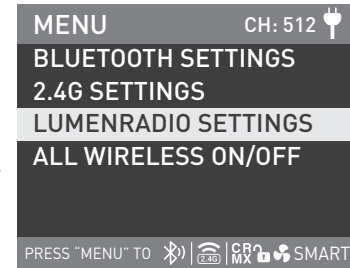
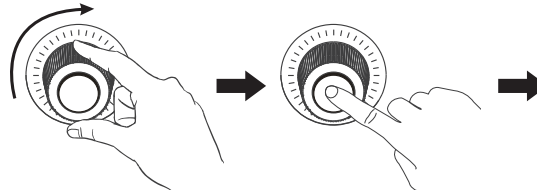
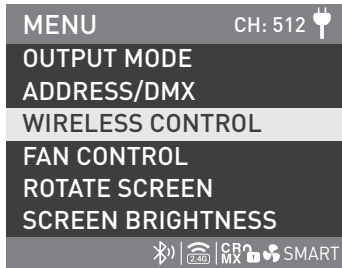

Rotate the "right knob" to WIRELESS CONTROL, and press the "right knob" to enter the corresponding secondary menu.

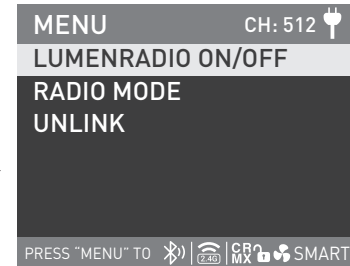
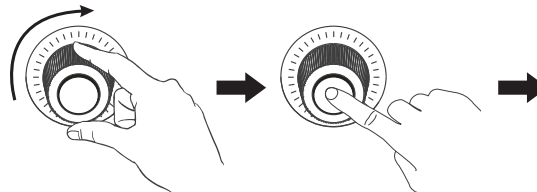
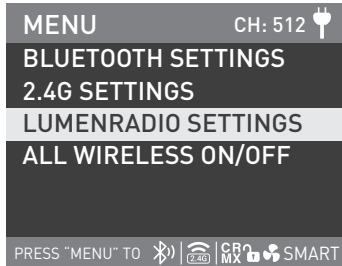

Rotate the "right knob" to LUMENRADIO SETTINGS, and press the "right knob" to enter the corresponding tertiary menu.

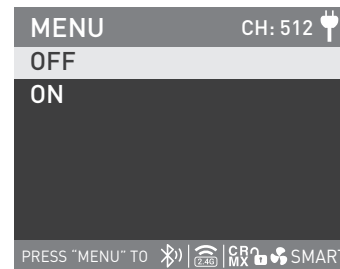
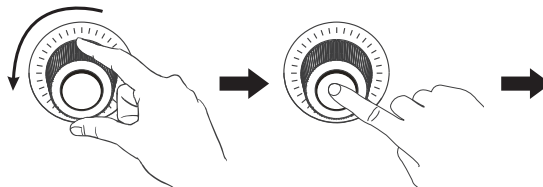
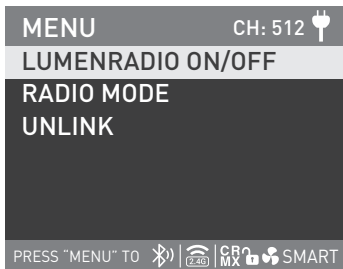

Rotate the "right knob" to LUMENRADIO ON/OFF, and press the "right knob" to enter the corresponding next level menu.

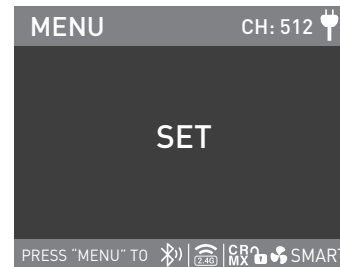
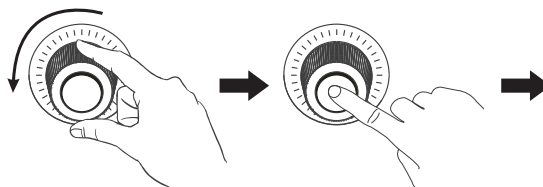
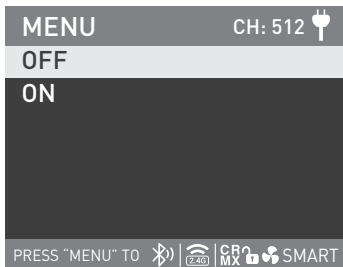

Rotate the "right knob" to select ON or OFF, and press the "right knob" to set.

CRMX wireless DMX signals can be received and transmitted when the LUMENRADIO is set to be on.



(1) RECEIVER MODE

RATIO MODE Setting

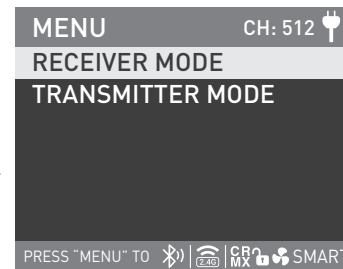
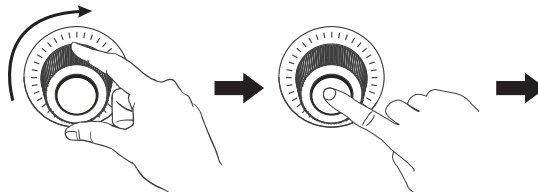
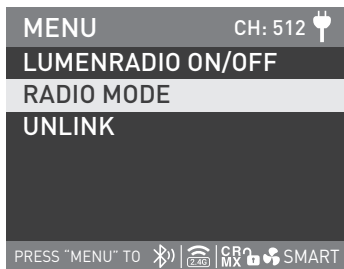

Rotate the "right knob" to RADIO MODE, and press the "right knob" to enter the next level menu.

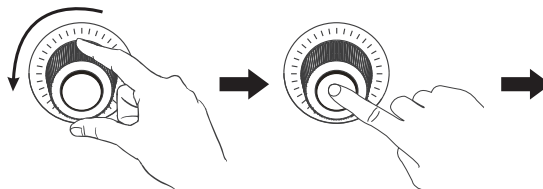
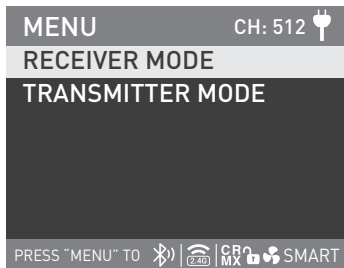

Rotate the "right knob" to select RECEIVER MODE, and press the "right knob" to set.

UNLINK Setting

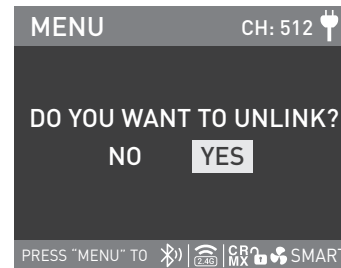
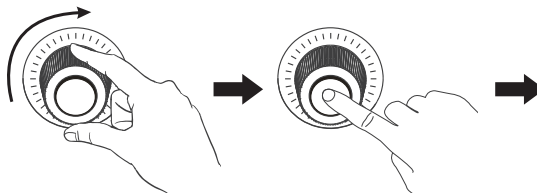
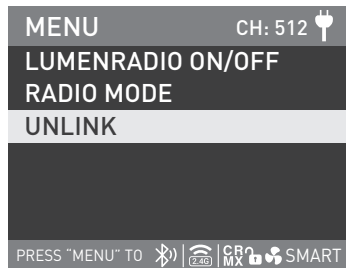

Rotate the "right knob" to UNLINK, and press the "right knob" to enter the next level menu.

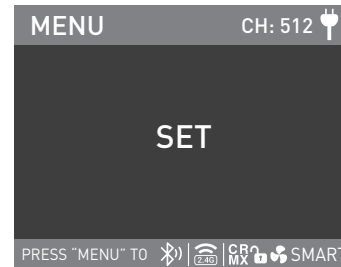
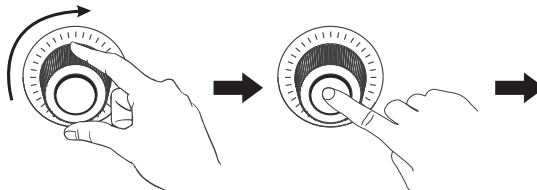
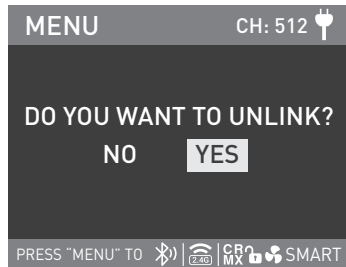

Rotate the "right knob" to select YES, and press the "right knob" to set.

Please refer to P31 of this manual or CRMX wireless DMX transmitter manual, to connect the fixture set in TRANSMITTER MODE or CRMX wireless DMX transmitter with the fixture set in RECEIVER MODE, the fixture will be able to receive CRMX wireless DMX signals for remote control.

Note: · CRMX wireless DMX transmitter is sold separately.

- In RECEIVER MODE, the LUMENRADIO SETTINGS should be set to UNLINK to allow it to be reconnected to the new fixtures or transmitters.

(2) TRANSMITTER MODE

Set the fixture to TRANSMITTER MODE, and connect with the DMX/RDM console.

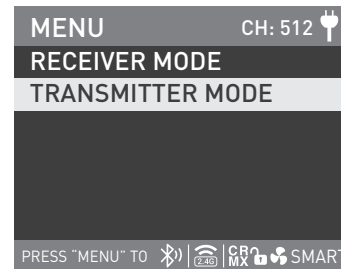
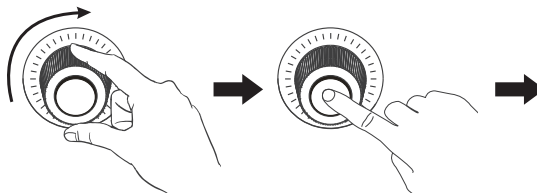
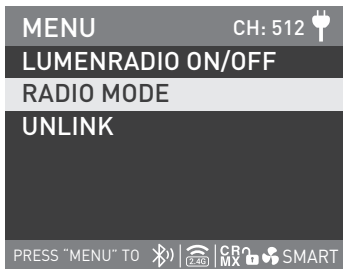

Rotate the "right knob" to RADIO MODE, and press the "right knob" to enter the next level menu.

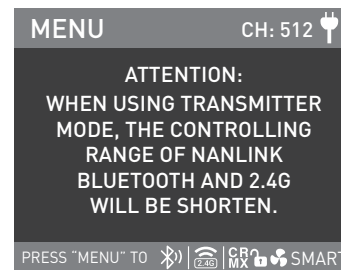
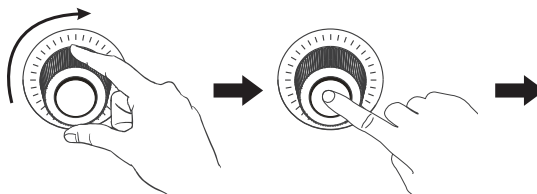
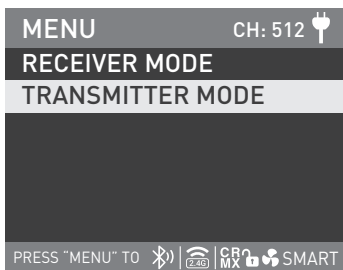

Rotate the "right knob" to select TRANSMITTER MODE and press the "right knob" to set.

The fixture can set the RF OUTPUT POWER when it is in TRANSMITTER MODE, the setting methods are as below:

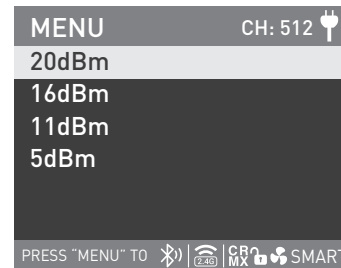
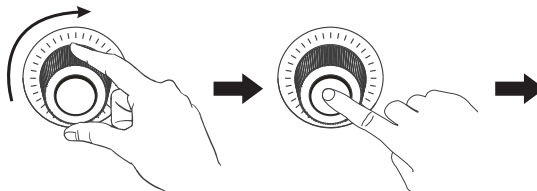
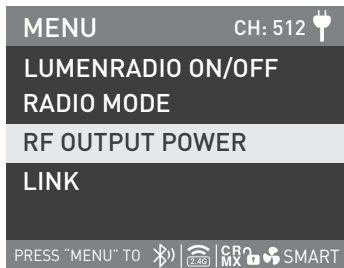

Rotate the "right knob" to RF OUTPUT POWER, and press the "right knob" to enter the next level menu.

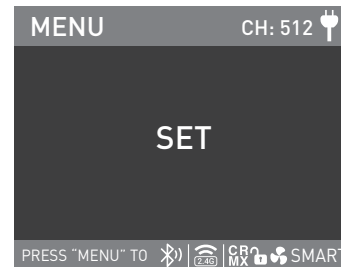
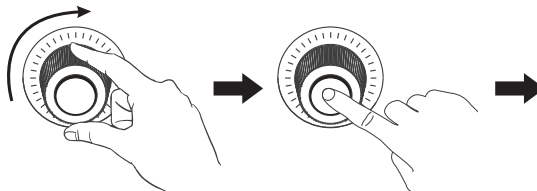
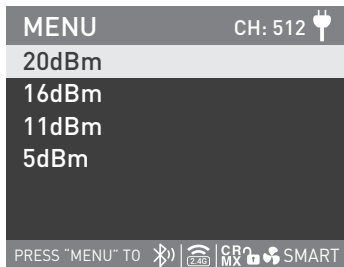

Rotate the "right knob" to select 20dBm, 16dBm, 11dBm or 5dBm, and press the "right knob" to set.

(3) Set other fixtures that need to receive CRMX wireless DMX signals to RECEIVER MODE and set to UNLINK. (For setting method, please refer to P27.)

Note: The controlling range of Nanlink Bluetooth and 2.4G remote control will be shortened when set to TRANSMITTER MODE.

(4) Connect the fixture set in TRANSMITTER MODE with the fixture set in RECEIVER MODE.

In TRANSMITTER MODE, the signal from the DMX/RDM console or DMX-based APP will be transmitted to the fixtures set in RECEIVER MODE.

The fixtures set in TRANSMITTER MODE should be set as below:

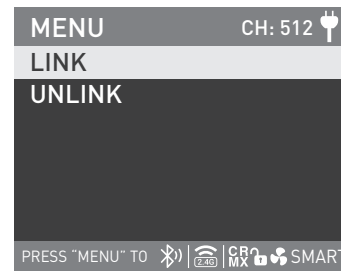
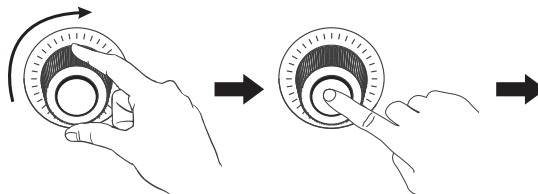
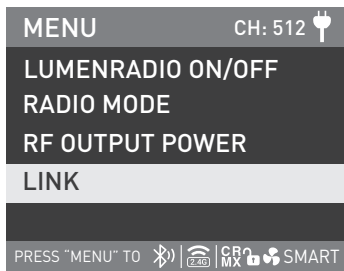

Rotate the "right knob" to LINK, and press the "right knob" to enter the next level menu.

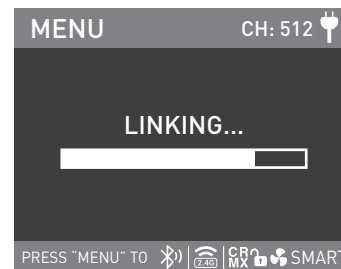
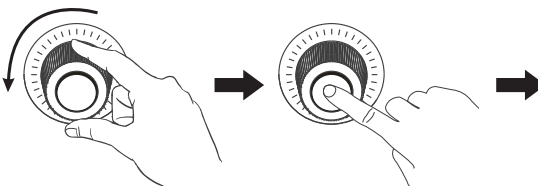

Rotate the "right knob" to select LINK, and press the "right knob" to set.

(5) UNLINK Setting

When the fixture needs to stop transmitting the CRMX wireless DMX signal, set the fixture to UNLINK. The setting method is the same as the UNLINK setting on P28.

④ ALL WIRELESS ON/OFF

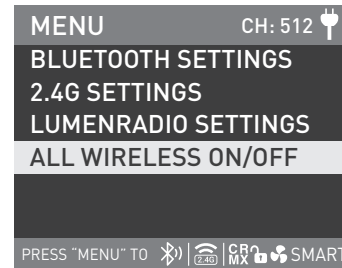
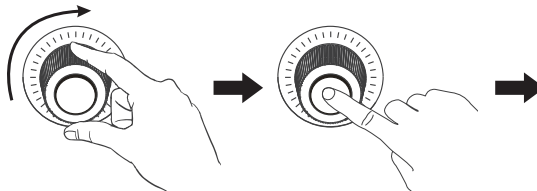
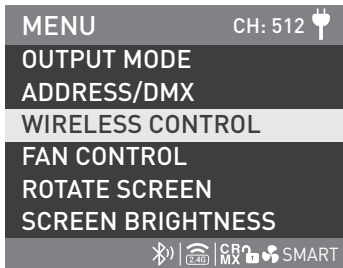

Rotate the "right knob" to WIRELESS CONTROL, and press the "right knob" to the secondary menu.

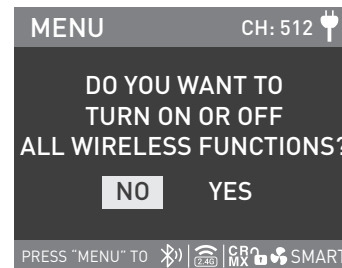
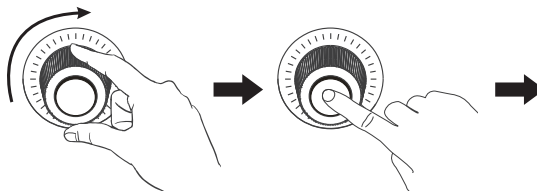
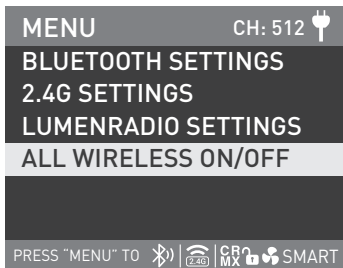

Rotate the "right knob" to ALL WIRELESS ON/OFF, and press the "right knob" to the tertiary menu.

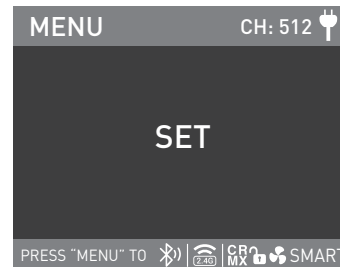
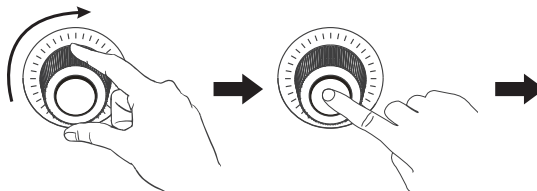
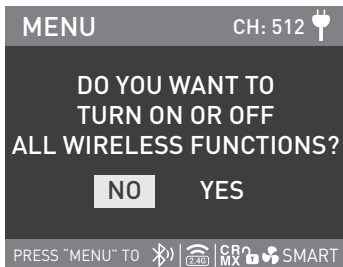

Rotate the "right knob" to select ON or OFF, and press the "right knob" to set.

When all wireless functions are set to be on, all the Bluetooth, 2.4G and LUMENRADIO settings will be in the ON state.

4. RDM Control

① Connect the light fixture to the console with RDM function, the connecting method is the same as that of DMX console.

② Control the fixture via a console with RDM function. (For specific operation instruction, please refer to the RDM console operation manual.)

Note: The UID format of the fixture is as follows:

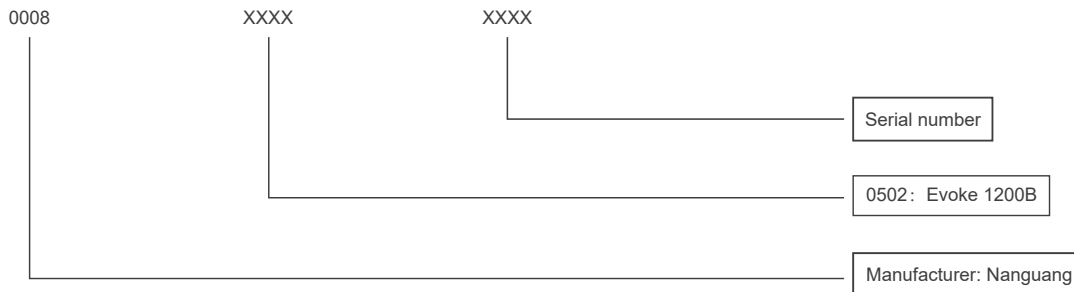

## Operating Instructions

1. First, make sure that the power switch of the control unit is in the "off" position. Now it is safe to connect the power adapter and power the unit on. If the power indicator is on that means the power supply is normal, the screen will display "NANLUX".

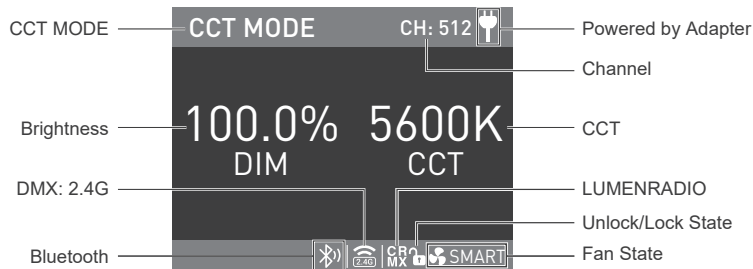

2. CCT Button: Press the CCT button to enter the CCT MODE.

① Brightness Setting: rotate the "left knob", clockwise to increase brightness while counterclockwise to reduce the brightness. The screen shows the percentage of brightness, DIM range: 0.0-100.0%.

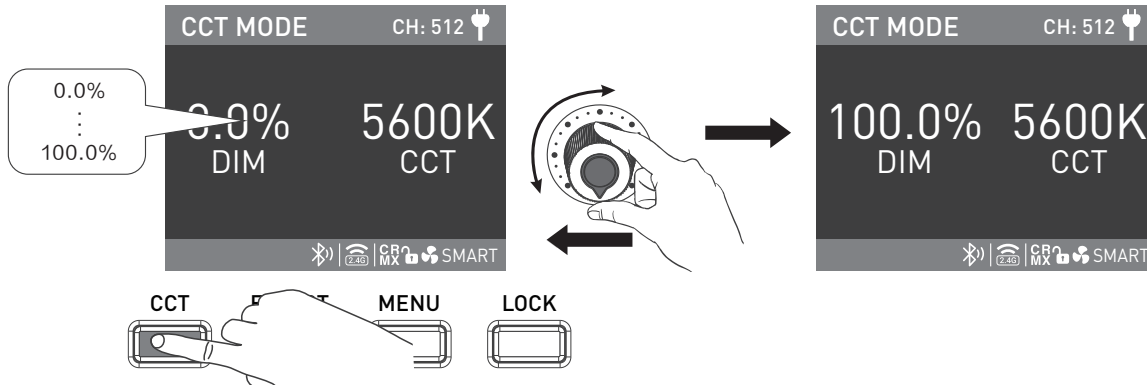

Note: In other modes, the brightness adjustment range is the same as in CCT mode. When the fixture function is unlock, in any mode, press the "left knob", the fixture is off, the brightness percentage on the screen will be 0.0%, press again, the fixture restores the previous state, press continuously to switch the fixture between on and off.



2. CCT Setting: rotate the "right knob", clockwise to increase color temperature while counterclockwise to reduce the color temperature. The screen shows the CCT, range from: 2700K-6500K.

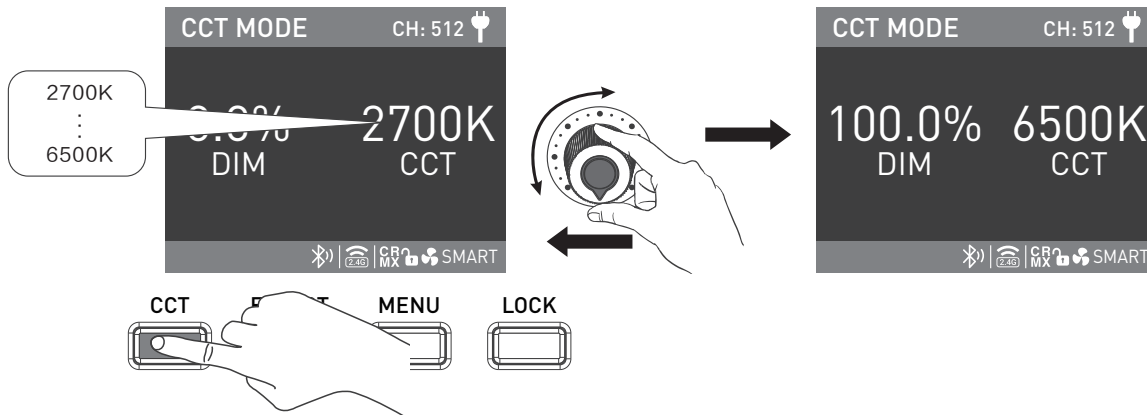

Note: In other modes, the CCT adjustment range is the same as in CCT mode. Press the "right knob" to promptly switch among 2700K, 3200K, 4300K, 5600K, 6500K, which is in a loop regulation.

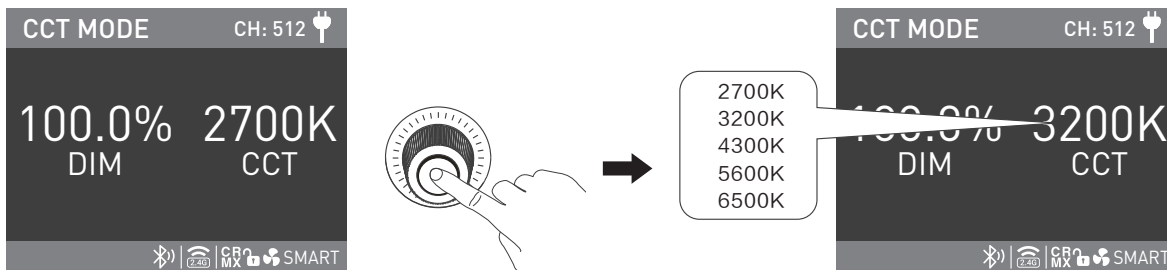

3.EFFECT Button: Press the EFFECT button to enter the EFFECT MODE.

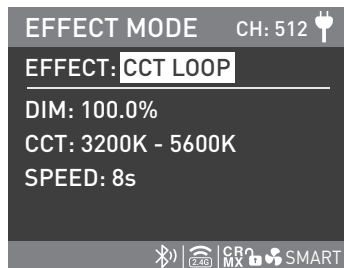

Left knob



Right knob

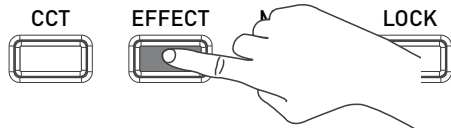

· Evoke 1200B has built-in effects including: CCT LOOP, INT LOOP, FLASH, PULSE, STORM AUTO, STORM MANUAL, TV, PAPARAZZI, CANDLE/FIRE, BAD BULB, FIREWORK, EXPLOSION AUTO, EXPLOSION MANUAL and WELDING.

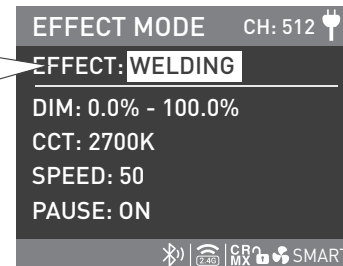
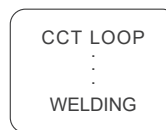
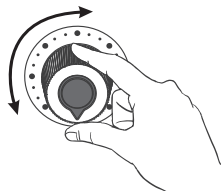
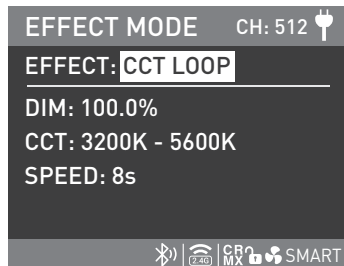

Rotate the "left knob" to select the effect.

① CCT LOOP

CCT LOOP setting, rotate the "right knob" to select DIM, CCT, SPEED (range from: 2s -30s), and rotate the "left knob" to set the parameters.

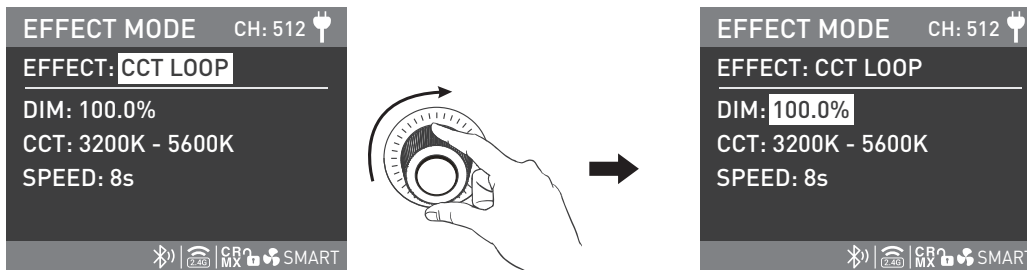

Rotate the "right knob" to select DIM, CCT, SPEED.

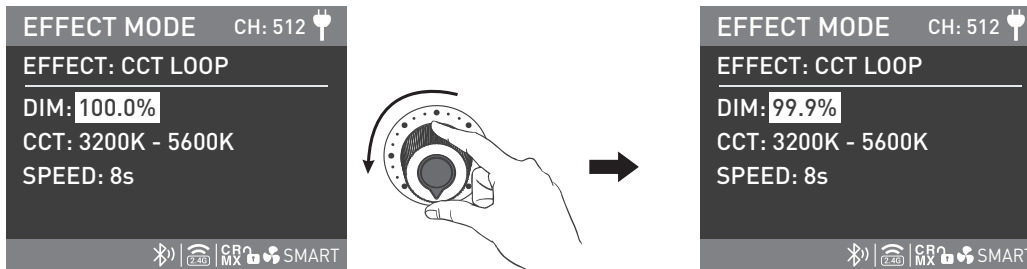

Rotate the "left knob" to set the corresponding parameters.

②INT LOOP

INT LOOP setting, rotate the "right knob" to select DIM, CCT, SPEED (range from: 2s -30s), and rotate the "left knob" to set the parameters.

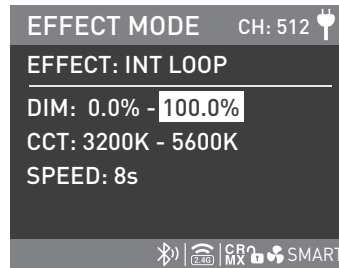
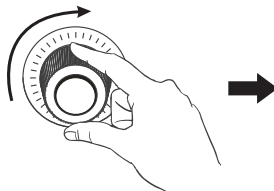
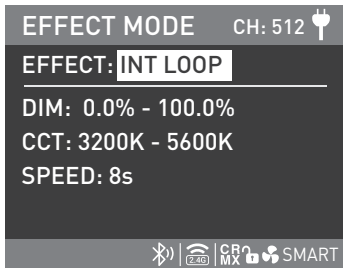

Rotate the "right knob" to select DIM, CCT, SPEED.

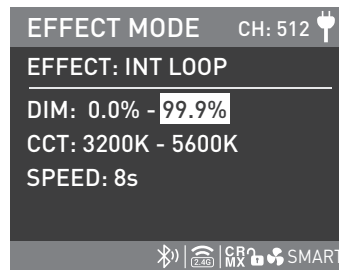
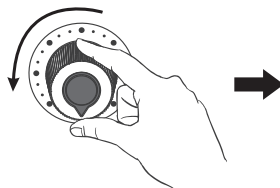
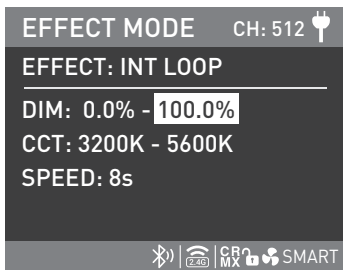

Rotate the "left knob" to set the corresponding parameters.

③ FLASH

FLASH setting, rotate the "right knob" to select DIM, CCT, INTERVALS (range from: 0.1s -10s) and FLASH RATIO (range from: 0% -100%), and rotate the "left knob" to set the parameters.

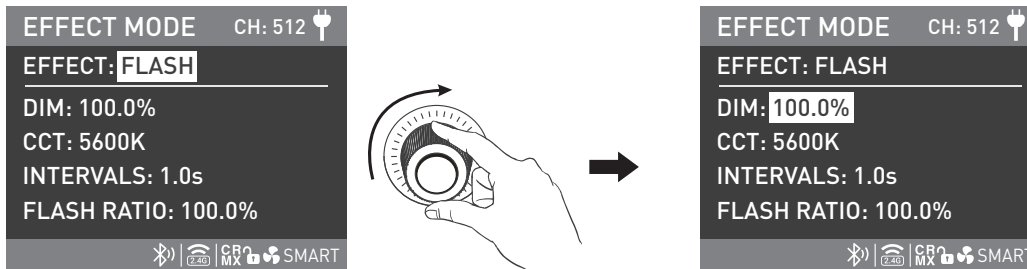

Rotate the "right knob" to select DIM, CCT, INTERVALS and FLASH RATIO.

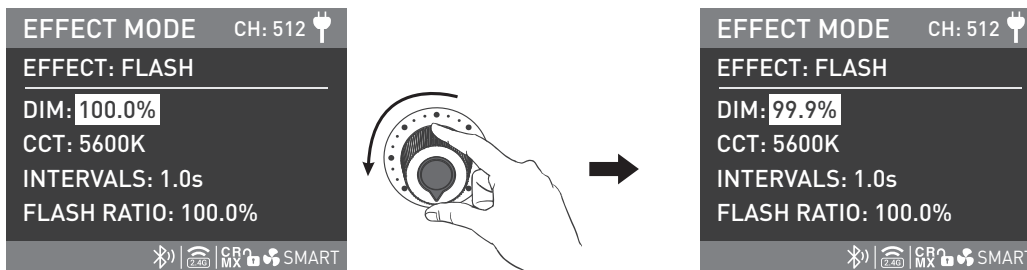

Rotate the "left knob" to set the corresponding parameters.

④PULSE

PULSE setting, rotate the "right knob" to select DIM, CCT and PULSES/MIN (range from: 1-240), and rotate the "left knob" to set the parameters.

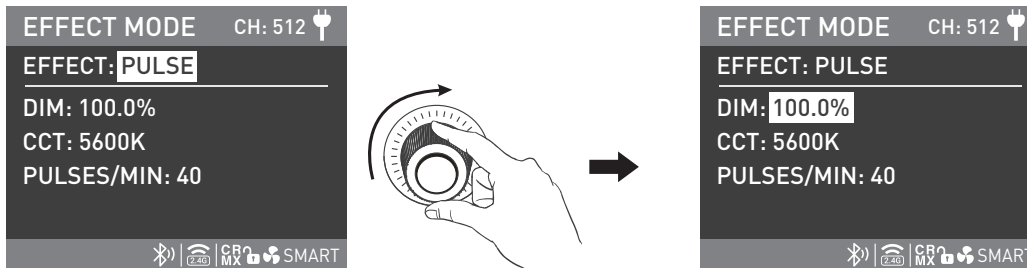

Rotate the "right knob" to select DIM, CCT and PULSES/MIN.

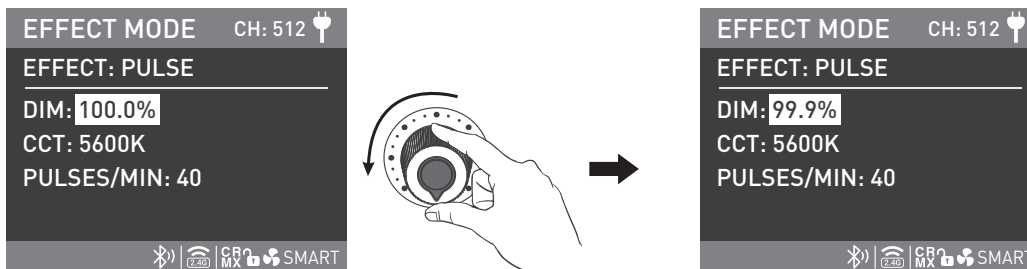

Rotate the "left knob" to set the corresponding parameters.

⑤ STORM AUTO

STORM AUTO setting, rotate the "right knob" to select DIM, CCT, INTVL RANGE (range from: 1s -60s), and rotate the "left knob" to set the corresponding parameters.

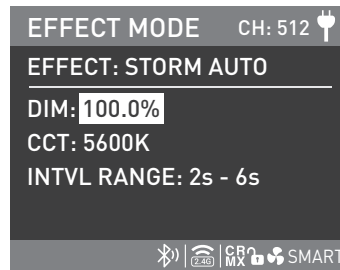
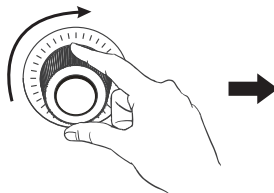
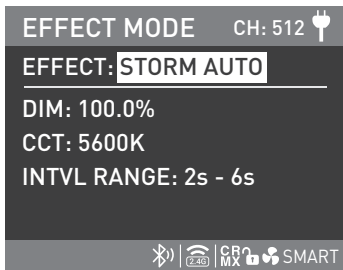

Rotate the "right knob" to select DIM, CCT and INTVL RANGE.

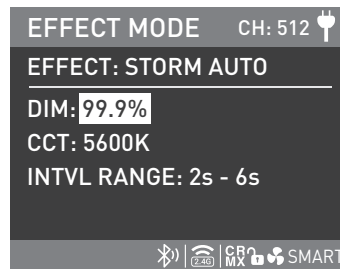
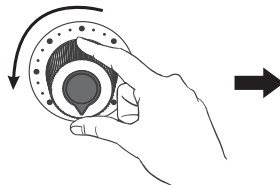
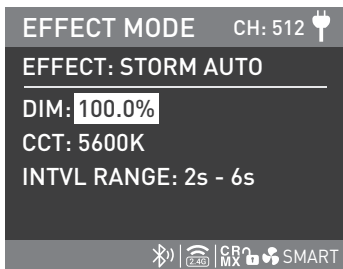

Rotate the "left knob" to set the corresponding parameters.

⑥ STORM AUTO

STORM AUTO setting, rotate the "right knob" to select DIM, CCT, and rotate the "left knob" to set the corresponding parameters, press the "right knob" to trigger the storm effect.

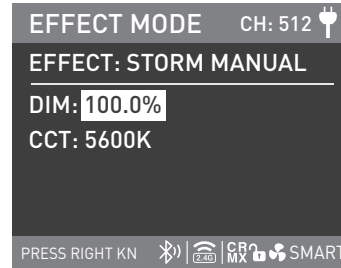
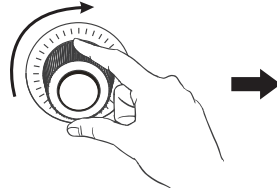
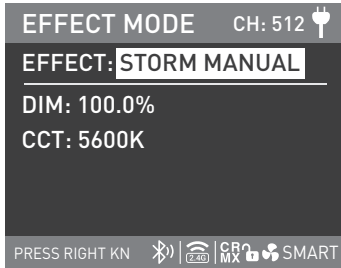

Rotate the "right knob" to select DIM and CCT.

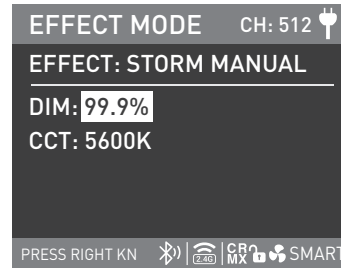
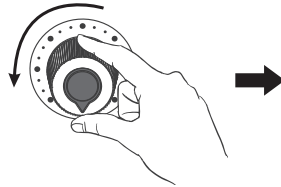
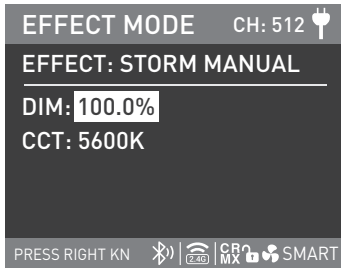

Rotate the "left knob" to set the corresponding parameters.

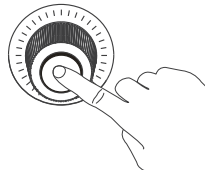
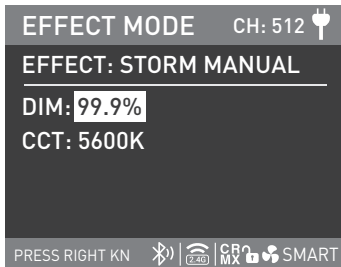

Press the "right knob" to trigger the storm effect.



⑦TV

TV setting, rotate the "right knob" to select DIM, CCT, CCT SHIFT (range from: 0K-3000K) and SPEED (range from: 1-100), and rotate the "left knob" to set the corresponding parameters.

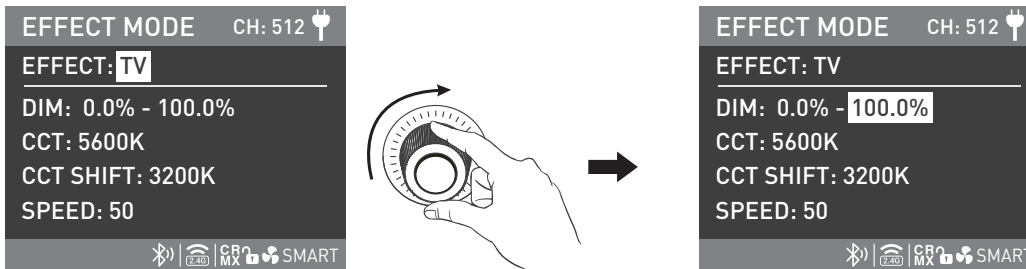

Rotate the "right knob" to select DIM, CCT, CCT SHIFT and SPEED.

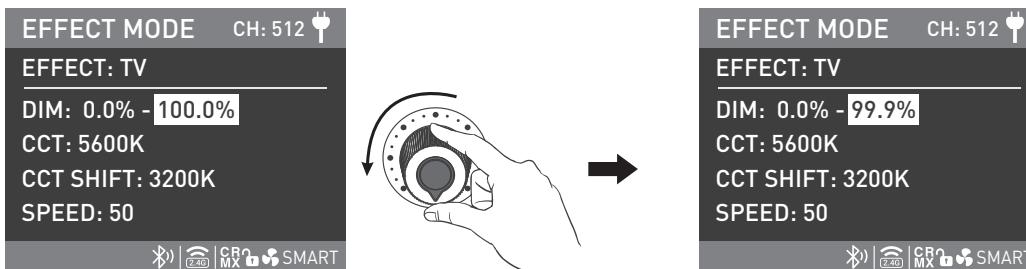

Rotate the "left knob" to set the corresponding parameters.

⑧PAPARAZZI

PAPARAZZI setting, rotate the "right knob" to select DIM, CCT and SPEED (range from:1-100), and rotate the "left knob" to set the corresponding parameters.

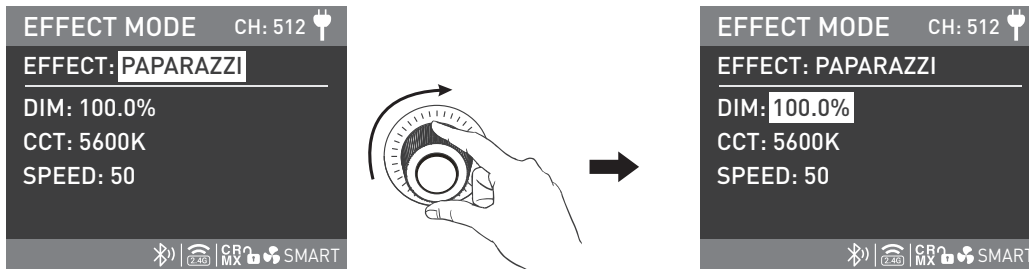

Rotate the "right knob" to select DIM, CCT and SPEED.

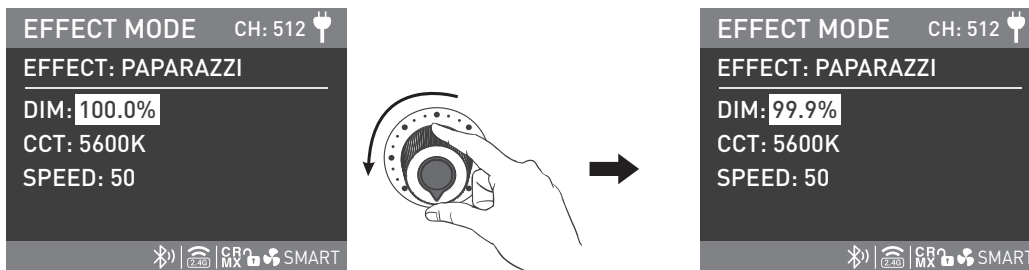

Rotate the "left knob" to set the corresponding parameters.

⑨ CANDLE/FIRE

CANDLE/FIRE setting, rotate the "right knob" to select DIM, CCT and SPEED (range from: 1-100), and rotate the "left knob" to set the corresponding parameters.

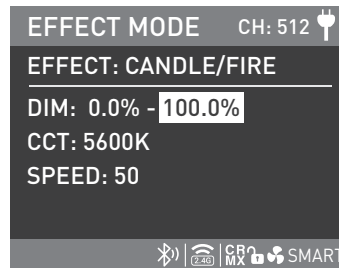
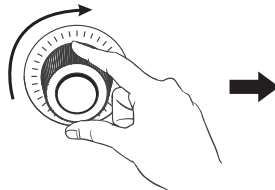
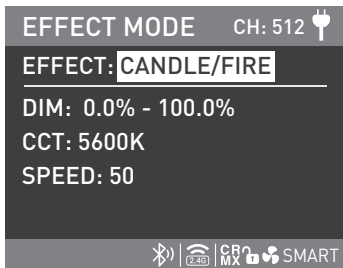

Rotate the "right knob" to select DIM, CCT and SPEED.

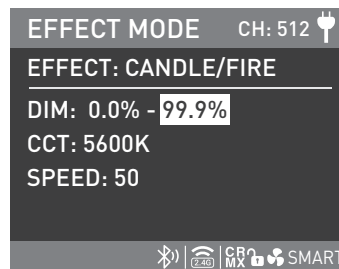
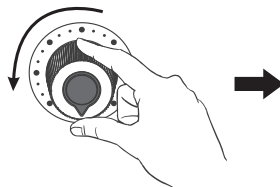
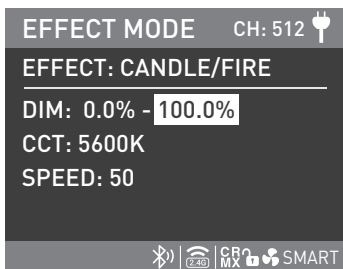

Rotate the "left knob" to set the corresponding parameters.

⑩BAD BULB

BAD BULB setting, rotate the "right knob" to select DIM, CCT, INTENSITY (range from: 1-100) and SPEED (range from: 1-100), and rotate the "left knob" to set the corresponding parameters.

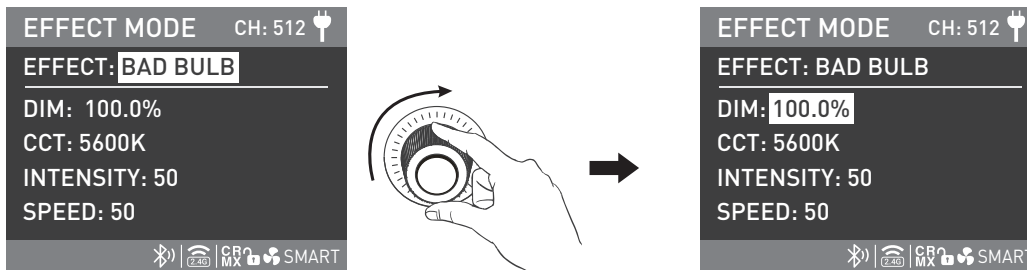

Rotate the "right knob" to select DIM, CCT, INTENSITY and SPEED.

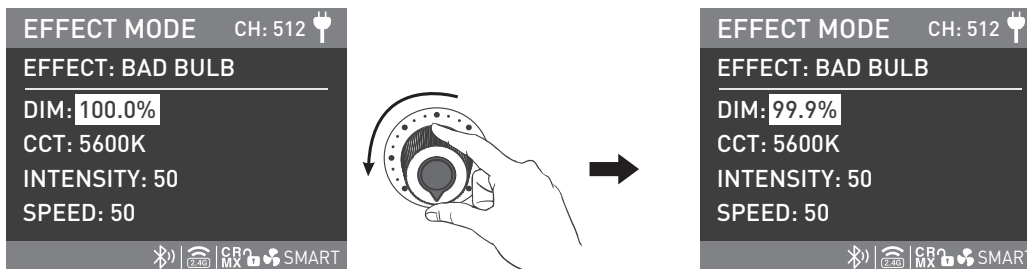

Rotate the "left knob" to set the corresponding parameters.

⑩ FIREWORK

FIREWORK setting, rotate the "right knob" to select DIM, CCT, SPEED (range from: 1-100) and DECAY (range from: 1-100), and rotate the "left knob" to set the corresponding parameters.

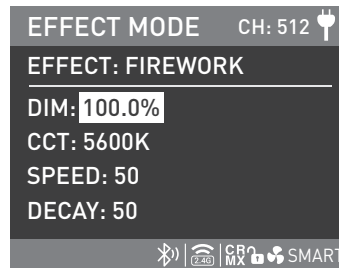
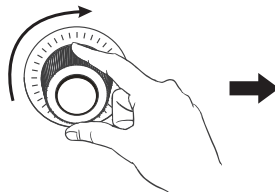
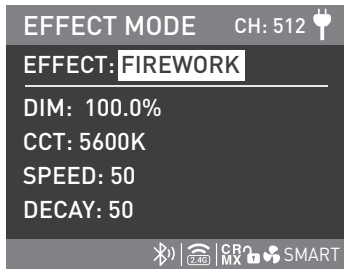

Rotate the "right knob" to select DIM, CCT, SPEED and DECAY.

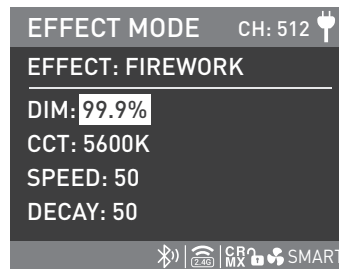
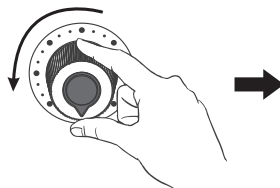
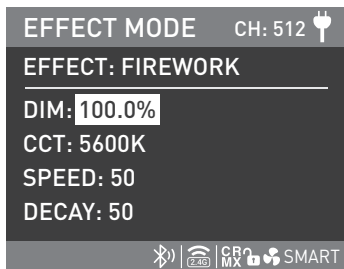

Rotate the "left knob" to set the corresponding parameters.

⑫EXPLOSION AUTO

EXPLOSION AUTO setting, rotate the "right knob" to select DIM, CCT, SPEED (range from:1-100) and DECAY (range from:1-100), and rotate the "left knob" to set the corresponding parameters.

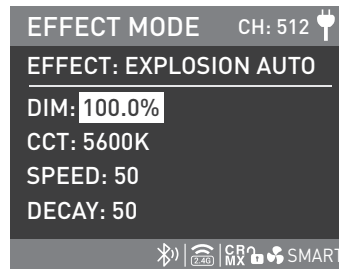
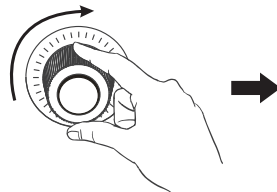
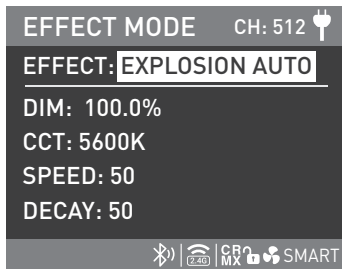

Rotate the "right knob" to select DIM, CCT, SPEED and DECAY.

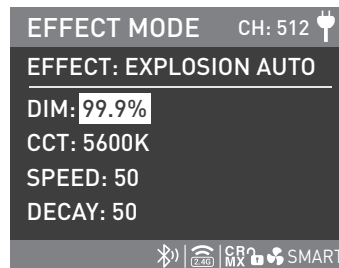
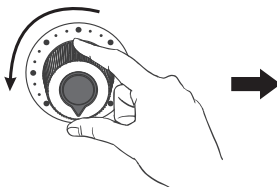
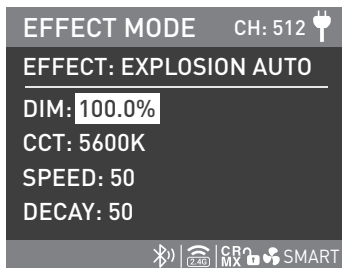

Rotate the "left knob" to set the corresponding parameters.

⑬ EXPLOSION MANUAL

EXPLOSION MANUAL setting, rotate the "right knob" to select DIM, CCT and DECAY (range from: 1-100), and rotate the "left knob" to set the corresponding parameters.

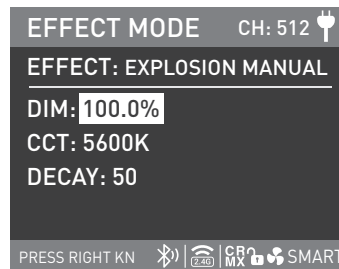
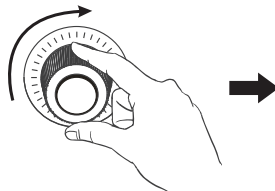
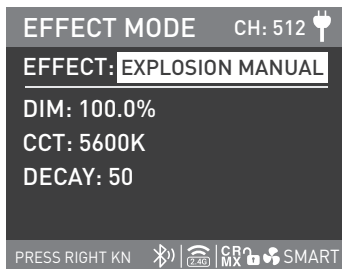

Rotate the "right knob" to select DIM, CCT and DECAY.

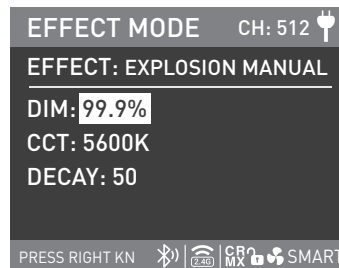
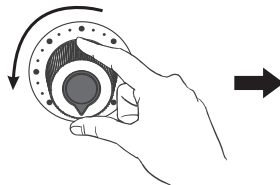
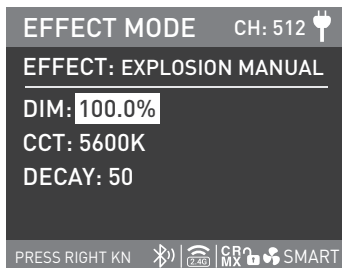

Rotate the "left knob" to set the corresponding parameters.

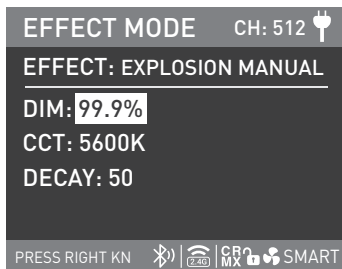

Press the "right knob" to trigger explosion.

⑭ WELDING

WELDING settings, rotate the "right knob" to select DIM, CCT, SPEED (range from: 1-100) and PAUSE (ON/OFF), and rotate the "left knob" to set the corresponding parameters.

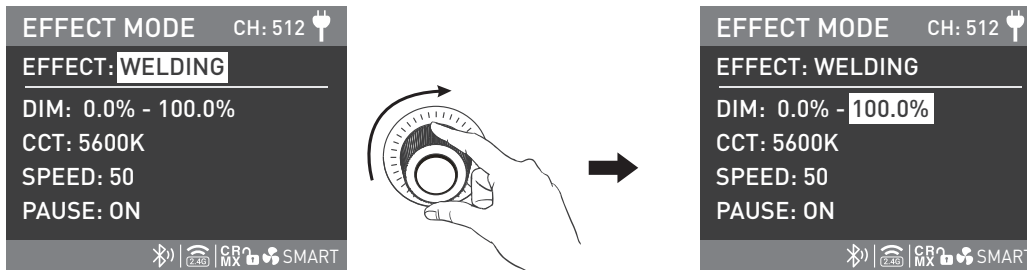

Rotate the "right knob" to select DIM, CCT, SPEED and PAUSE.

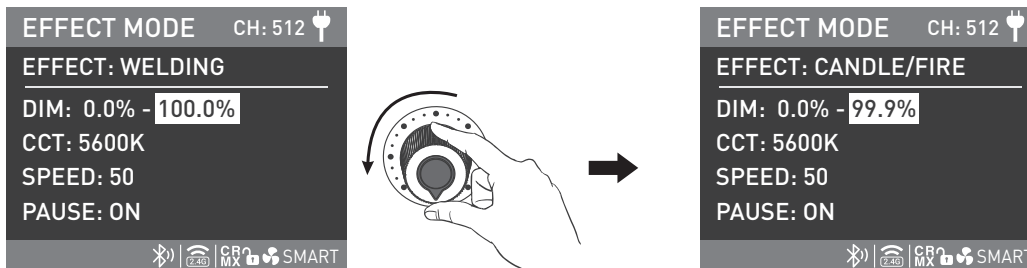

Rotate the "left knob" to set the corresponding parameters.

Note: When the PAUSE setting is in ON state, the welding effect will suspend.

- Lighting effects and additional functionality will be probably upgraded with later firmware version. Detailed information is subject to the instruction of firmware function.



4. MENU Button: Press the MENU button to enter the interface of menu.

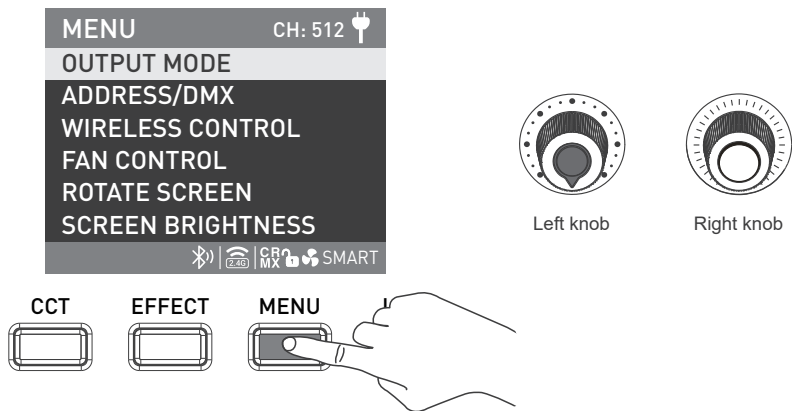

- Rotate the "right knob" to select the options, press the "right knob" to enter the corresponding secondary menu, and rotate the "right knob" again to select the corresponding options and press the "right knob" to set. Press the MENU button to return to the previous menu.

① OUTPUT MODE

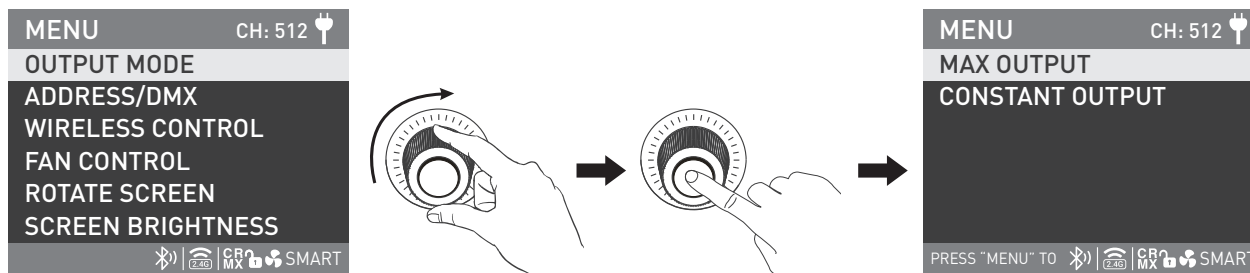

Rotate the "right knob" to OUTPUT MODE, and press the "right knob" to enter the secondary menu.

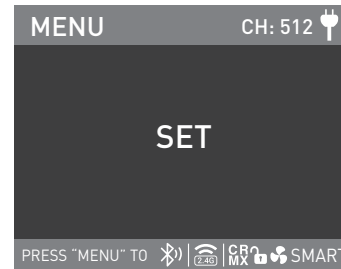
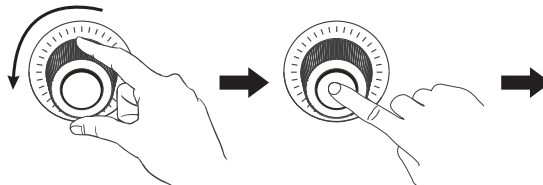
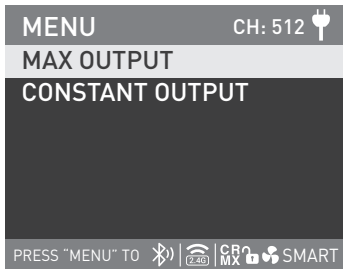

Rotate the "right knob" to select MAX OUTPUT or CONSTANT OUTPUT, and press the "right knob" to set.

② ADDRESS/DMX

For more operation details please refer to P12.

③ WIRELESS CONTROL

For more operation details please refer to P19.

④ FAN CONTROL

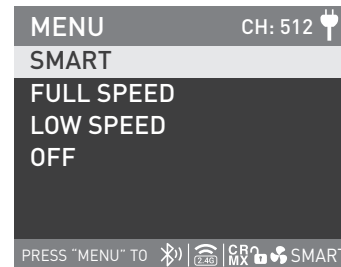
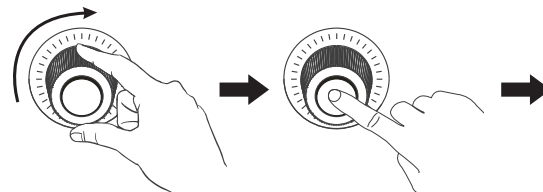

Rotate the "right knob" to FAN CONTROL, and press the "right knob" to enter the corresponding secondary menu.

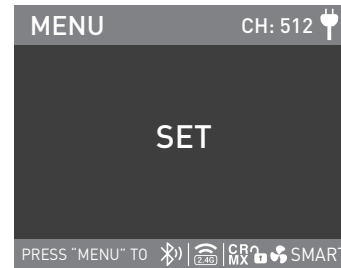
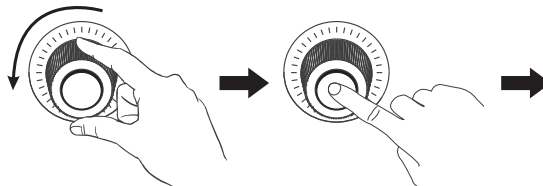
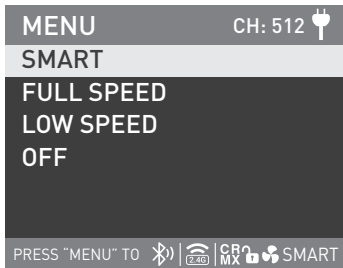

Rotate the "right knob" to select SMART, FULL SPEED, LOW SPEED and OFF, and press the "right knob" to set.

Note: When the fan is off, the built-in fan will stop working, and the maximum output of fixture is 10%. When the fan is in low speed, the maximum output is 50%.

When the fan is in smart or full speed state, the maximum output is 100%.

⑤ ROTATE SCREEN

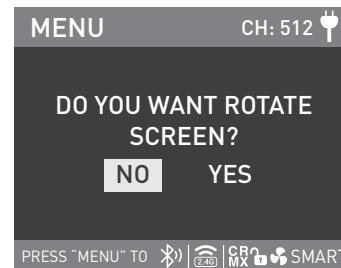
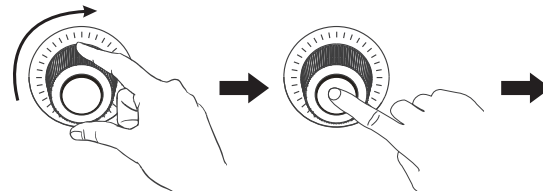

Rotate the "right knob" to the ROTATE SCREEN, and press the "right knob" to enter the corresponding secondary menu.

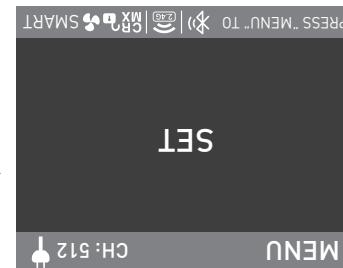
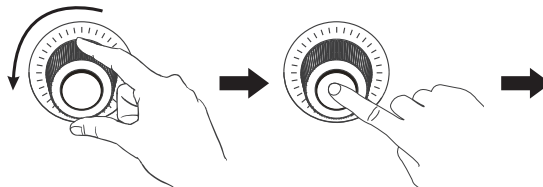
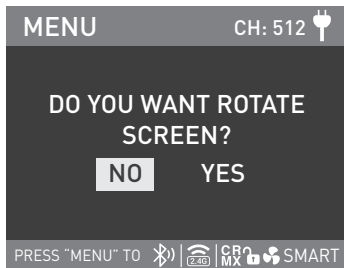

Rotate the "right knob" to select YES or NO, and press the "right knob" to set.

⑥ SCREEN BRIGHTNESS

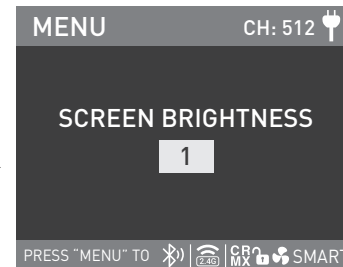
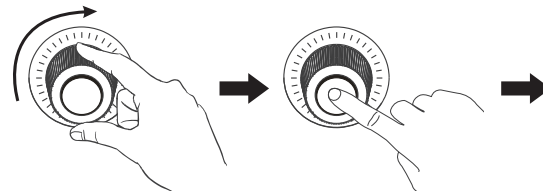

Rotate the "right knob" to SCREEN BRIGHTNESS, and press the "right knob" to enter the corresponding secondary menu.

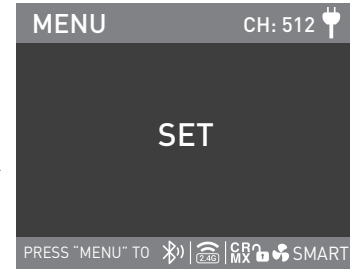
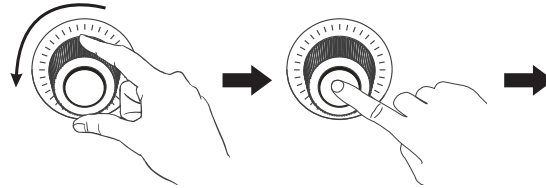
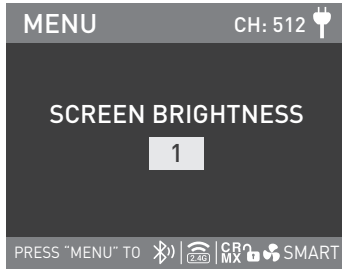

Rotate the "right knob" to select the screen brightness, and press the "right knob" to set.

⑦ BUTTON BACKLIGHT

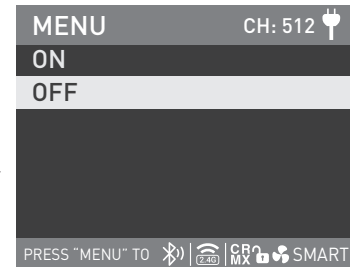
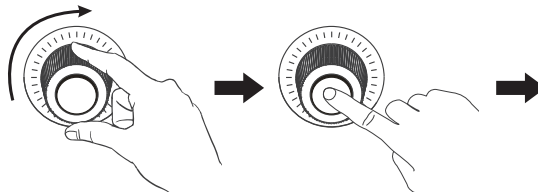
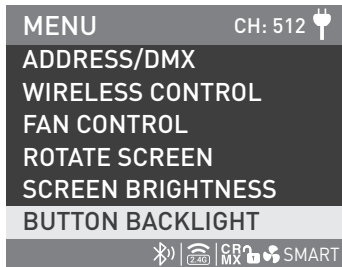

Rotate the "right knob" to BUTTON BACKLIGHT, and press the "right knob" to enter the corresponding secondary menu.

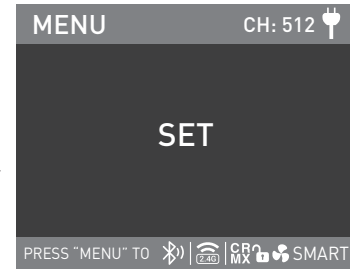
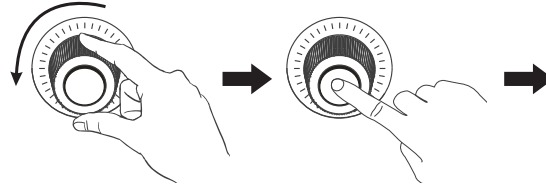
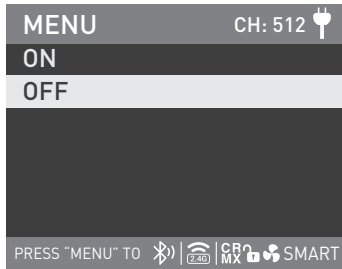

Rotate the "right knob" to select ON or OFF, and press the "right knob" to set.

⑧ LANGUAGE

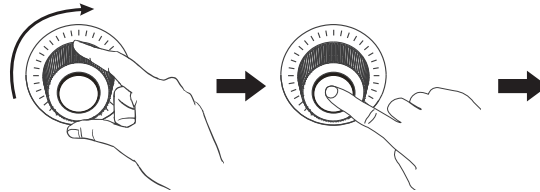
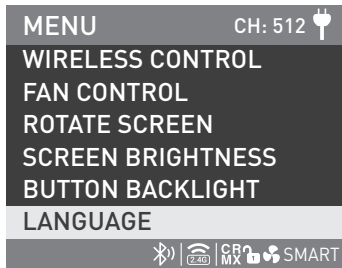

Rotate the "right knob" to LANGUAGE, and press the "right knob" to enter the corresponding secondary menu.

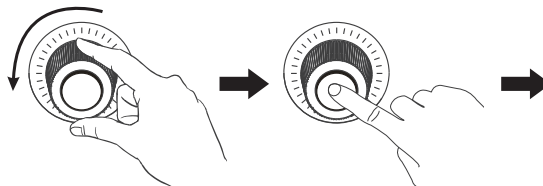

Rotate the "right knob" to select ENGLISH or 简体中文, and press the "right knob" to set.

⑨ FIRMWARE UPDATE

Turn off the fixture before making firmware update, connect a USB drive with the latest firmware file to the fixture, and turn on the fixture to make update.

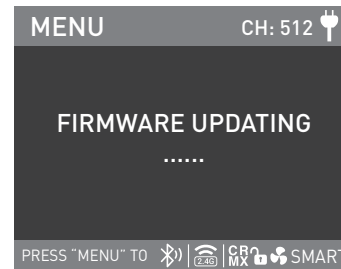
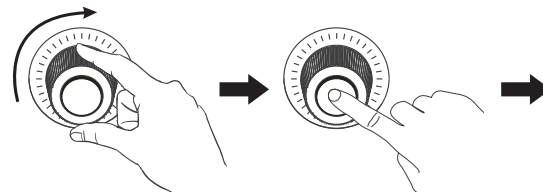
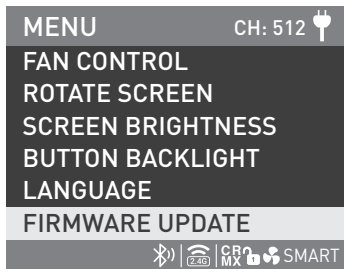

Connect a USB drive with the latest firmware file to the fixture, in the menu, rotate the "right knob" to FIRMWARE UPDATE, and press the "right knob" to enter.

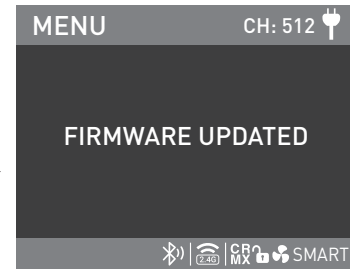
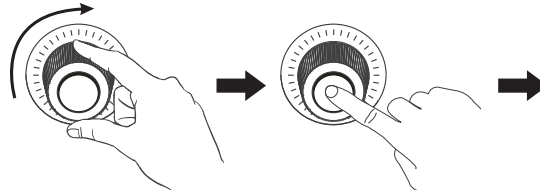
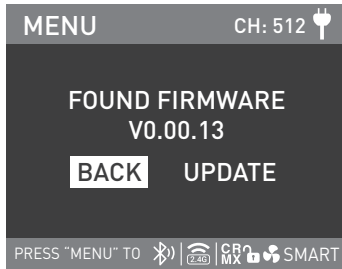

Rotate the "right knob" to UPDATE, and press the "right knob" to make firmware update. The screen will show FIRMWARE UPDATED after the update is done and then the fixture will restart automatically.

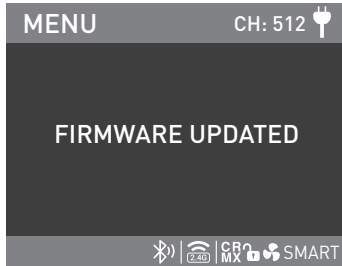



VERSION

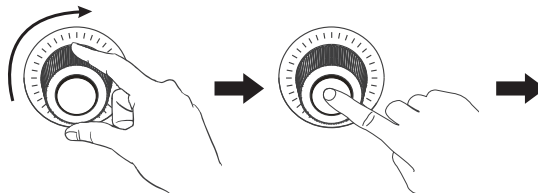
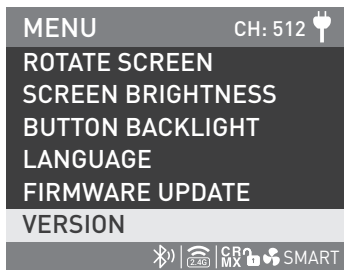

Rotate the "right knob" to VERSION, and press the "right knob" to check the current version.

5. LOCK Button: Long press the "LOCK" to lock the settings, at this moment, any operation or adjustment on the button and knob will not change the current setting. Long press the LOCK button again to unlock.

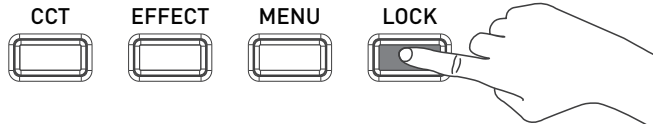
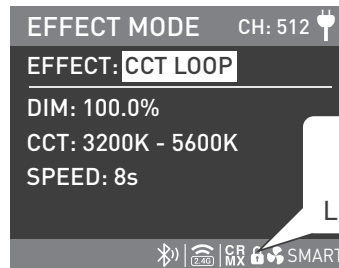
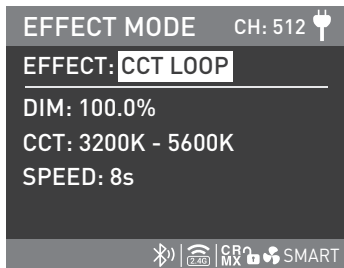

6. When the fixture is not in use, please turn off the power switch.

## Safety Precautions

1. Please check for possible damage caused in transit after opening the package. Please do not use if damage is found. And contact with the distributor or manufacturer as soon as possible.
2. Please do not use a power cable with damaged insulation. Please do not unplug too hard or drag the power cable directly.
3. Please make sure the voltage of power supply accords with the voltage specified on the fixture before installation.
4. Please turn the fixture off when it is not in use or before cleaning.
5. Please keep the fixture safely stored and away from children.







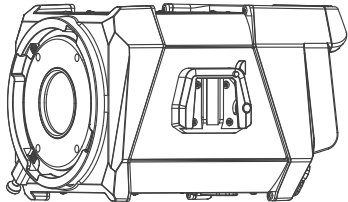
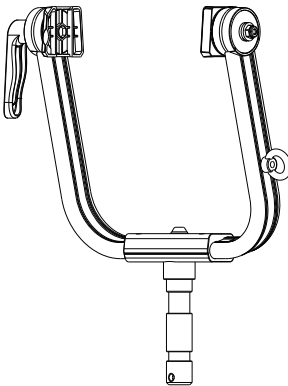
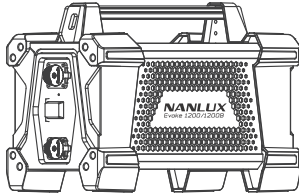
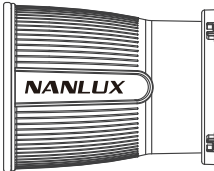

## Notice

1. Please do not look directly at the emitter when the light is on.
2. Please do not place the fixture near any flammables and explosives.
3. Please do not immerse the fixture in water. Water resistance fixtures refer to rainproof and anti-spraying, but not submersible or underwater use. Please do not put the fixture and cable close to or contact with water if any damage is found.
4. Please do not place the fixture near any flammable or volatile substances like alcohol or gasoline
5. Please do not use strong detergent for cleaning. Please wipe off the dirt by using a cloth with neutral cleanser when cleaning the fixture.
6. Please hold the handle securely when detaching the accessories or adjusting the beam directions, since the accessories such as lens and softbox are heavy.
7. Please do not cover the vents when using, to avoid affecting heat dissipation, and resulting in damage. Please pay attention to anti-scald when using the fixture for a long time, since the surface temperature of fixture will be high.
8. Please do not disassemble the fixture at will to repair by yourself. Qualified professionals should conduct maintenance under the condition of strictly following the operating procedures described in this manual.

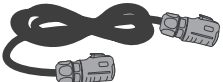
## General Fault Detection and Diagnosis

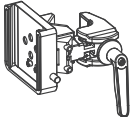
Fault Detection	Diagnosis
The light won't boot up properly	<ol style="list-style-type: none"> <li>1. Please check whether the connection between power adapter and cable or fixture are loose.</li> <li>2. Please check whether the voltage value is within the specified parameters.</li> </ol>
The fixture can be operated manually, but DMX control is not working.	<ol style="list-style-type: none"> <li>1. Please check whether the DMX original address setting of the fixture is correct.</li> <li>2. Please check that the XLR signal cable is connected correctly and that it is not faulty or damaged.</li> </ol>
LCD display is on, but light cannot be operated.	Please check if the LCD display shows "  ". Press and hold the "LOCK" button for 2s to release the LOCK.
The fan doesn't work	<ol style="list-style-type: none"> <li>1. Please check if the fan is OFF</li> <li>2. If the screen displays ""Fan abnormal", please contact with the supplier or manufacturer for replacement.</li> </ol>
The signal reception distance of 2.4G and Bluetooth is less than 5 meters.	Check whether the LUMENRADIO is in TRANSMITTER MODE, if it is, please disconnect the LUMENRADIO and set it in RECEIVER MODE.

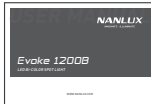
**What's in the box? Please kindly check.**

Evoke 1200B ×1		Yoke ×1		Power Supply ×1	
					
				Reflector ×1	USB Flash Drive ×1
					
Connection Cable ×1	Power Cable ×1	AS-CP-QR-EV ×1	DMX Reference Guide ×1	User Manual ×1	Thank-you Card ×1
					

This manual and all stats within it were produced under controlled conditions, and are accurate at time of print. Any future changes to design/technical data can be found at [www.nanlux.com](http://www.nanlux.com).

Version: V1 2022-08-08

 +86-754-85751187

 +86-754-85300887

 [info@nanlux.com](mailto:info@nanlux.com)

 Zhanglin,324,Dongli Chenghai Shantou Guangdong China

**Guangdong NanGuang Photo&Video Systems Co., Ltd**